

3-20-2014

Soil Remediation using Solvent Extraction with Hydrodehalogenation and Hydrogenation in a Semicontinuous System

Robert John Panczer

University of South Florida, rjpanczer@mail.usf.edu

Follow this and additional works at: <https://scholarcommons.usf.edu/etd>

 Part of the [Environmental Engineering Commons](#)

Scholar Commons Citation

Panczer, Robert John, "Soil Remediation using Solvent Extraction with Hydrodehalogenation and Hydrogenation in a Semicontinuous System" (2014). *Graduate Theses and Dissertations*.
<https://scholarcommons.usf.edu/etd/5092>

This Thesis is brought to you for free and open access by the Graduate School at Scholar Commons. It has been accepted for inclusion in Graduate Theses and Dissertations by an authorized administrator of Scholar Commons. For more information, please contact scholarcommons@usf.edu.

Soil Remediation Using Solvent Extraction with Hydrodehalogenation and Hydrogenation
in a Semicontinuous System

by

Robert J. Panczer

A thesis submitted in partial fulfillment
of the requirements for the degree of
Master of Science in Environmental Engineering
Department of Civil and Environmental Engineering
College of Engineering
University of South Florida

Major Professor: Jeffrey Cunningham, Ph.D.
Qiong Zhang, Ph.D.
John Kuhn, Ph.D.

Date of Approval:
March 20, 2014

Keywords: Catalyst, Palladium, Rhodium, Dechlorination, Tetrachlorobenzene

Copyright © 2014, Robert J. Panczer

Acknowledgments

I would like to thank my advisor, Dr. Jeff Cunningham, for all the hours spent mentoring me and reviewing my work. I would also like to thank my committee members, Dr. John Kuhn and Dr. Qiong Zhang, for the time they dedicated to reviewing this thesis.

This work is supported in part by the National Science Foundation under Grant No. DUE 0965743. Any opinions, findings, conclusions, or recommendations expressed in this thesis are those of the author and do not necessarily reflect the views of the National Science Foundation.

Table of Contents

List of Tables	iii
List of Figures	iv
Abstract	v
Chapter 1: Motivation, Introduction, and Objectives	1
1.1 Motivation.....	1
1.2 Introduction to Remedial Extraction and Catalytic Hydrodehalogenation.....	2
1.3 Objectives	5
Chapter 2: Review of Catalyst Poisoning and Methods for Preventing Poisoning	6
2.1 Catalyst Deactivation by Poisoning.....	6
2.2 Methods of Reducing Catalyst Poisoning.....	8
2.3 Catalytic Deactivation in REACH.....	9
2.4 Ultraviolet Degradation of Organic Matter.....	10
Chapter 3: Materials and Methods.....	11
3.1 Materials (General Analysis).....	11
3.2 Contaminated Soil.....	12
3.2.1 Contamination Procedure.....	12
3.2.2 TeCB Concentration in Artificially Contaminated Soil.....	13
3.3 Construction of the REACH System	14
3.4 First Experiments: Semi-Continuous Operation of REACH with Soil	16
3.5 Second Experiments: REACH with Spiked Solvent (no soil).....	16
3.6 Third Experiments: Batch Testing of Catalyst Activity	17
3.6.1 Catalyst Deactivation Batch Reactor Experiment Procedure	17
3.6.2 Catalyst Cleaning Method.....	18
3.7 Fourth Experiment: Test of Hydrogen Delivery.....	19
3.8 Fifth Experiment: Ultraviolet Treatment of Solvent.....	20
3.8.1 Extraction of Organic Matter from Soil.....	20
3.8.2 UV Solvent Treatment / Catalyst Preparation	21
3.8.3 UV Solvent Treatment Batch Reactor Procedure	21
3.8.4 Color Spectrophotometer Test	22
3.9 Sampling Procedure during REACH Operation.....	22
3.10 Gas Chromatograph Methods	23
3.10.1 GC Overview	23
3.10.2 GC Analysis of TeCB	24
3.10.3 GC Analysis of Benzene/Cyclohexane.....	25

Chapter 4: Results and Discussion.....	28
4.1 First Experiments: Semi-Continuous Operation of REACH with Soil	28
4.2 Second Experiments: REACH with Spiked Solvent (no soil)	33
4.3 Third Experiments: Batch Testing of Catalyst Activity	35
4.4 Fourth Experiment: Test of Hydrogen Delivery	36
4.5 Fifth Experiment: Ultraviolet Treatment of Solvent.....	38
4.6 Discussion and Implications	39
Chapter 5: Conclusion.....	40
References Cited	43

List of Tables

Table 3.1 Chemical Specifications	12
Table 3.2 Gas Specifications and Use.....	12
Table 3.3 REACH Detailed Component and Part Information	15
Table 3.4 Gas Chromatograph Capillary Column Specifications.....	23
Table 4.1 Catalyst Deactivation Batch Experiments	36
Table 4.2 Summary of Hydrogen Delivery Batch Experiments	37
Table 4.3 UV Solvent Treatment Batch Experiments Summary	38

List of Figures

Figure 1.1 Diagram of a Typical Activated Carbon Sorption Process	2
Figure 1.2 Diagram of the REACH Soil Decontamination Method.....	3
Figure 1.3 Diagram of the Semi-continuous REACH Process.....	4
Figure 3.1 Calibration Plot for TeCB	25
Figure 3.2 Calibration Plot for Benzene	27
Figure 3.3 Calibration Plot for Cyclohexane	27
Figure 4.1 One Week Concentration Plot of REACH (after soil column)	29
Figure 4.2 One Week Concentration Plot of REACH (after Pd column).....	30
Figure 4.3 One Week Concentration Plot of REACH (after Rh column)	31
Figure 4.4 One Week Concentration Plot of REACH (after solvent reservoir)	32
Figure 4.5 One Week Concentration Plot of REACH (with spiked solvent)	34

Abstract

The objective of this thesis is to aid in the development of Remedial Extraction And Catalytic Hydrodehalogenation (REACH), a green remediation technology used to remove and destroy halogenated hydrophobic organic compounds from soil. REACH has no secondary waste streams, uses an environmentally benign solvent, and aims to catalytically destroy rather than transfer the organic contaminants into a different phase. In this thesis, a bench-top semi-continuous model of the proposed remediation technology was constructed and used to extract the model contaminant, 1,2,4,5-tetrachlorobenzene, from soil and to convert it to an acceptable end product, cyclohexane. Palladium was used as a catalyst for hydrodehalogenation, which converted the tetrachlorobenzene to benzene. Rhodium was used to catalyze the hydrogenation of benzene to cyclohexane.

A novel method, ultraviolet solvent treatment, was proposed to mitigate catalyst deactivation that occurs because of extracted chemicals contained in the contaminated soil. The goal of this treatment is to degrade organic matter that is suspected of causing catalyst deactivation.

The REACH process was found to successfully extract TeCB from the soil, but only partial conversion from TeCB to cyclohexane occurred. Catalyst deactivation was the suspected cause of the low amount of conversion observed. Hydrogen limitation was also tested as a cause of limited conversion, but was not found to be a contributor. Ultraviolet solvent treatment was

tested as a means of mitigating catalyst deactivation. However, the treatment was not effective in making a profound difference in stopping the catalyst from deactivating.

The experiments conducted in this research show that REACH has the potential to become a viable technology for cleaning soil contaminated with halogenated organic compounds. However, future research needs to be done to greatly reduce the severity of catalyst deactivation and to determine with which other halogenated organic compounds the technology works well.

Chapter 1: Motivation, Introduction, and Objectives

1.1 Motivation

Halogenated hydrophobic organic compounds (HHOCs) are common contaminants present at many sites on the EPA's National Priorities List (i.e., "Superfund" sites). HHOCs include chlorinated benzenes, polychlorinated biphenyls, and chlorinated phenols. The Comprehensive Environmental Response, Compensation, and Liability Act (CERCLA) requires the EPA to compile a list of the top contaminants of concern at Superfund sites. Currently, the list contains 275 contaminants (ATSDR 2011). Of those 275, at least 57 are HHOCs, including 10 chlorinated benzenes, 6 chlorinated phenols, 11 polychlorinated biphenyls, 6 halogenated dioxins, 9 halogenated furans, and 15 chlorinated pesticides. Because of their low vapor pressure and low aqueous solubility, HHOC contaminants typically reside in soil instead of water or air. Due to the toxic and recalcitrant nature of HHOCs, an efficient and environmentally-sound method for removing HHOCs from contaminated soil is necessary.

Existing remediation technologies to treat HHOC-contaminated soil include biodegradation, incineration, and solvent extraction followed by adsorption onto activated carbon. Biodegradation involves selecting or stimulating a group of microbial organisms to biodegrade the contaminants under site-specific conditions. Several drawbacks to biodegradation are that the microorganisms take a long time to degrade the contaminants, it has not been proven to be effective at treating a wide variety of compounds, and toxic byproducts are often produced (Speitel and Closmann 1991). Incineration involves burning the soil to destroy any contaminants.

However, incineration is energy intensive, produces harmful by-products like dioxins, and creates an additional waste stream of contaminated scrubber water and ash (Tuppurainen et al. 1998; Stanmore 2004). Therefore, solvent extraction might be an attractive option for treating HHOC-contaminated soil.

1.2 Introduction to Remedial Extraction and Catalytic Hydrodehalogenation

A solvent extraction process with adsorption onto activated carbon uses solvent to remove the contaminant from soil and transfers it to activated carbon. A schematic of such a system is shown in Figure 1.1 (US EPA 2001). A significant drawback of this method is that it transfers, rather than destroys, the contaminant of concern. A secondary waste stream, contaminated activated carbon, needs to be cleaned via a secondary cleanup method or disposed of in a landfill.

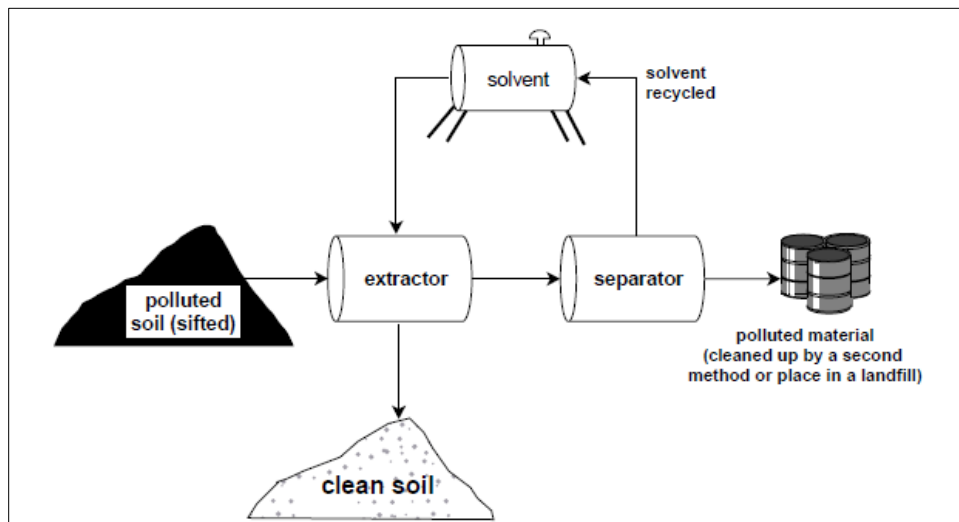

Figure 1.1 Diagram of a Typical Activated Carbon Sorption Process. Taken directly from the US EPA (2001). Note a secondary waste stream is created while decontaminating the soil.

To address this shortcoming of the traditional solvent extraction technique, Wee and Cunningham (2008, 2011, 2013) introduced remedial extraction and catalytic hydrodehalogenation, or REACH. REACH is a ‘green’ soil remediation technology for destroying HHOCs that eliminates secondary waste streams. REACH uses solvent extraction coupled with catalytic halogenation to convert halogenated organic compounds to less harmful chemicals. The REACH process is considered to be semi-continuous since the water/ethanol solvent is continuously flowing, but the soil is treated in individual batches in a stationary soil column (Wee and Cunningham 2011, 2013). Figure 1.2 shows the REACH soil remediation technology as proposed by Wee and Cunningham (2011, 2013).

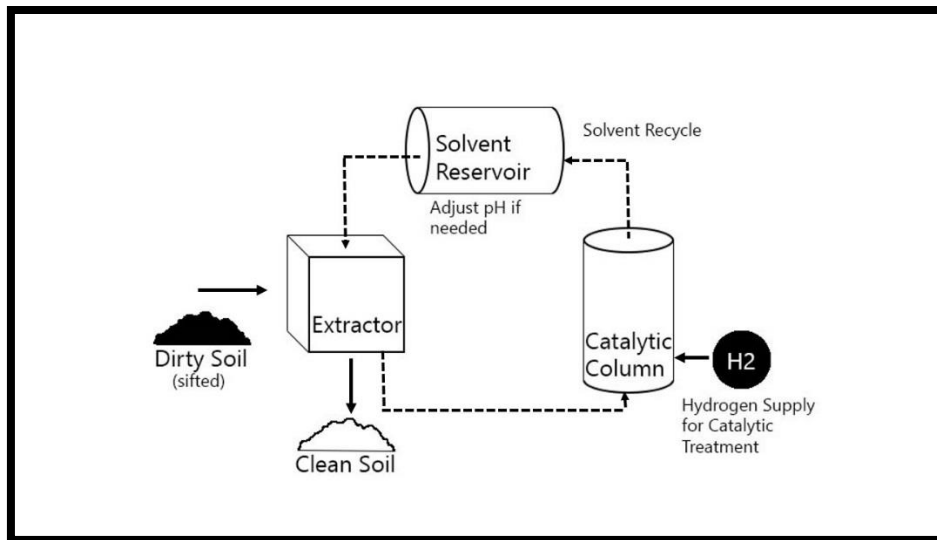

Figure 1.2 Diagram of the REACH Soil Decontamination Method. Note that no secondary waste stream is generated and the solvent is reused.

Previously, REACH has been proven to convert 1,2,4,5-tetrachlorobenzene (TeCB) to benzene in both batch and semi-continuous experiments using a palladium-on-alumina catalyst (Wee and Cunningham 2011, 2013). In semi-continuous experiments Wee and Cunningham (2011) achieved over 90% extraction and conversion of TeCB to benzene in 1 week. A diagram

of the bench-scale apparatus used for semi-continuous conversion of tetrachlorobenzene to benzene is shown in Figure 1.3.

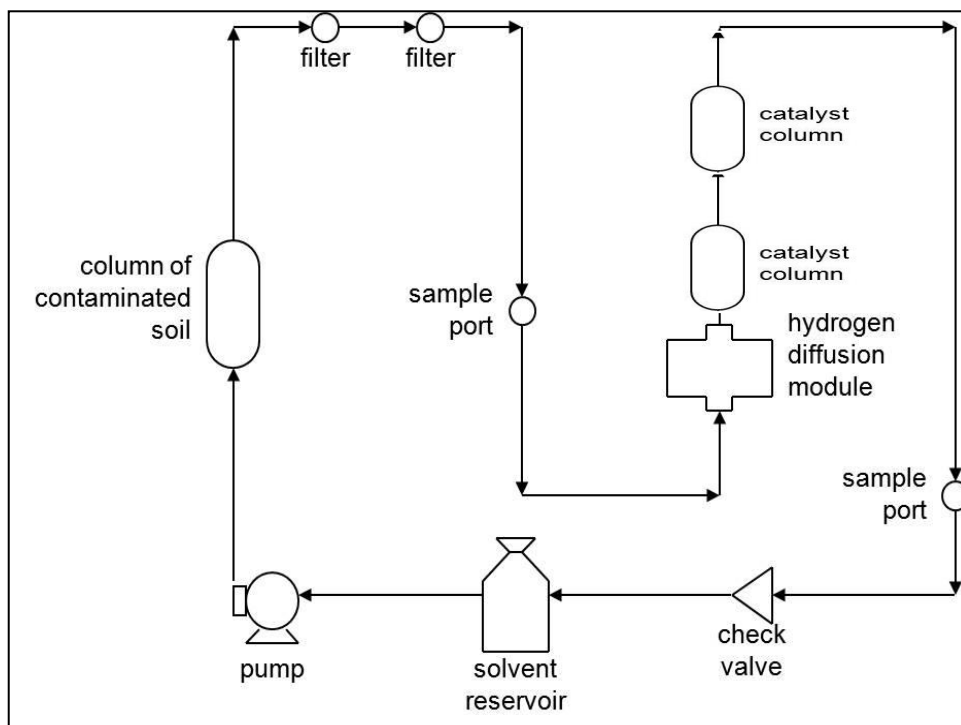

Figure 1.3 Diagram of the Semi-continuous REACH Process. Shown with two catalyst columns. (After Wee and Cunningham 2011).

Benzene, however, is still toxic, and is likely not an acceptable end product in most applications. To address this, catalytic hydrodehalogenation of TeCB has been combined with catalytic hydrogenation of benzene to cyclohexane, a benign end product (Osborn 2011; Ticknor 2012; Cone 2013). Previous experiments by Osborn (2011), Ticknor (2012), and Cone (2013) proved that it is possible to convert TeCB to cyclohexane in a batch process using both palladium and rhodium catalysts. Cyclohexane is still harmful to the environment, and needs to be disposed of properly in accordance with local, state, and federal laws. Cone (2013) demonstrated that in a batch reactor, TeCB in a solution of water and ethanol could be converted nearly 100% to cyclohexane in 8-12 hours. However, thus far, no one has demonstrated

palladium and rhodium can be used in a semi-continuous REACH process like that of Wee and Cunningham (2011).

Furthermore, Wee and Cunningham (2011) observed that the REACH process was effective at treating one of two soils tested, but was ineffective at treating the other soil because of catalyst deactivation. Pentachlorophenol could be extracted from the soil, but little to no conversion was observed. Clearly, such a decrease in catalyst activity could have a significant impact on REACH's effectiveness. Therefore, the degree to which the catalyst is being deactivated must be assessed and a method to mitigate catalyst deactivation should be developed.

1.3 Objectives

Therefore, the objectives of this thesis are: (1) Assess the extent to which the REACH technology can extract TeCB from contaminated soil and convert it to an acceptable end product (i.e., cyclohexane) in a semi-continuous operation; (2) Assess the extent at which catalyst is deactivated during operation of the REACH technology; and (3) Assess a proposed method (employing solvent pre-treatment using ultraviolet light) of controlling catalyst deactivation.

TeCB is selected as a "model" HHOC because it has physical and chemical properties similar to many of the HHOCs found at sites on the National Priorities List. If the REACH technology is found successful of cleaning soil contaminated with TeCB, then there is a reasonable likelihood that it would be applicable to other HHOCs as well. By extracting and converting the contaminants, the technology will be viewed as successful in treating the contaminated soil. Assessing the extent to which catalyst is deactivated by compounds extracted from the soil is important in identifying key obstacles of the technology, as is investigating possible methods for controlling catalyst deactivation.

Chapter 2: Review of Catalyst Poisoning and Methods for Preventing Poisoning

This chapter will review catalyst deactivation in the semi-continuous REACH system, heterogeneous catalyst deactivation by poisoning, and detail background information on using ultraviolet light to breakdown dissolved organic matter in water. Catalyst deactivation, as defined by Bartholomew (2001), is “the loss over time of catalytic activity and/or selectivity”. It was been speculated that poisoning from extracting soil compounds causes the catalyst to deactivate in REACH (Wee 2007). Therefore, this chapter will assist in understanding deactivation by poisoning and the methods used to prevent it. In addition to poisoning, there are several other mechanisms by which catalysts can become deactivated, including fouling (physisorption) and metal leaching (Moulijn et al. 2001). However, those processes are not reviewed here because they are unlikely to be relevant in the REACH system, since the most-likely cause of deactivation is poisoning by dissolved organic matter (Wee 2007).

2.1 Catalyst Deactivation by Poisoning

Catalyst poisoning is defined as “strong chemisorption of species on catalytic sites, thereby blocking sites for catalytic reaction” (Bartholomew 2001). Thus, poisoning is one type of process that can lead to deactivation. Sulfur species and organic matter are common catalyst poisons found during heterogeneous catalytic reactions that cause reversible catalyst deactivation.

Sulfur species are one of the main groups of compounds that decrease catalyst activity, with H_2S and HS^- being the two most potent compounds (Berube et al. 1987; Lowry and Reinhard 2000; Navon et al. 2012). Navon et al. (2012) observed sulfite poisoning of palladium catalysts when treating chlorinated organic compounds in wastewater in a batch reactor. Navon et al. (2012) observed significant catalyst deactivation by sulfite by the second batch reactor run. Angeles-Wedler et al. (2009) observed similar sulfite deactivation when treating wastewater contaminated at trace levels ($1.77 \mu\text{M}$ of sulfite). Lowry and Reinhard (2000) also observed sulfite caused deactivation when treating naturally and artificially TCE contaminated groundwater with a palladium catalyst. Angeles-Wedler (2009) also observed that as pH increased to neutral ($\text{pH}=7$) sulfide poisoning had a more noticeable effect on catalyst activity.

Organic matter, a second group of compounds that deactivate metallic catalysts, are of particular importance in soil treatment process, like that of REACH. Kopinke (2010) observed palladium catalyst deactivation when treating a solution containing natural organic matter. Catalyst activity was severely decreased after contact with a 40 mg/L solution of dissolved organic matter. Much of the activity loss in catalytic treatment of solvents is caused by organic matter competing for active sites on the metallic catalysts (Doong 2005; Tratnyek 2001; Zhang 2008). Gross et al. (2010) also observed palladium catalyst being deactivated by dissolved organic matter (humic acids) when deoxygenating water. Chaplin et. al (2006) also found similar deactivation by dissolved organic matter when treating groundwater using a bimetallic palladium/copper catalyst on alumina.

Chloride, a common product of dehalogenation reactions, may also cause catalyst poisoning (Heck 2009). In systems similar to REACH, chloride poisoning could occur when chloride is free from a parent compound (e.g. TeCB). The chloride in the solvent then competes

with the target molecules for active catalyst sites. This decreases the reaction rate, and a poorer performance of the system is observed. Simone (1991) also observed chloride poisoning when using palladium as a methane combustion catalyst. The poisoning observed was also attributed to chloride causing localized active site poisoning.

Since catalyst deactivation by poisoning is one of the largest barriers to catalytic remediation in industry, methods of protecting catalysts need to be further developed.

2.2 Methods of Reducing Catalyst Poisoning

Methods developed to protect catalyst activity involve coating the catalyst surface or adding additives to the catalyst to transform sulfur compounds.

Various coatings have been used in research to prevent or reduce catalyst deactivation. Navon et al. (2012) observed a decrease in deactivation when treating wastewater using a palladium/alumina catalyst coated with a silicone polymer. The silicone was used to serve as a barrier to keep potential catalyst poisons from reaching Pd active sites. Over time the silicone polymer began to degrade and become more susceptible to sulfite poisoning. Zeolites have also been used by Schüth et al. to prevent sulfite fouling of palladium catalysts (2000). The catalyst embedded in zeolite reduced chlorinated hydrocarbons in groundwater when regenerated periodically. Exclusion of sulfite compounds and other ion poisons was accomplished by utilizing the zeolite's micropores to allow the entrance of target contaminants and the exclusion of poisons. Other researcher have used metals to modify the electronic structure of palladium. Heck et al. (2009) used gold particles to alter the electronic structure of palladium, which led to the catalyst being able to significantly resist sulfite deactivation when compared to Pd on alumina catalyst.

Introducing additives into the catalyst has also been used as a means of mitigating catalyst deactivation. Scavengers, or compounds used to bind with the deactivating compound, were added by Kung (1992). This process involves impregnating inactive catalyst sites with ZnO. Compounds like sulfite interact with the chemical additive, forming zinc sulfide and other related compounds.

2.3 Catalytic Deactivation in REACH

Rapid catalyst deactivation is one of the main obstacles in making the REACH technology viable in the field.

In past work, Wee (2007) treated two types of soils contaminated with organic pollutants in the semi-continuous bench-top model using a palladium catalyst. One soil was an uncontaminated soil taken 10 cm below the surface in College Station, TX. Upon analysis, the soil was found to be 78% sand, 6% silt, and 16% clay (Wee 2007). Organic matter and pH were found to be 0.30% and 5.1, respectively. The second soil was collected from a depth of 15-30 cm below the ground surface in Quincy, Florida. After analysis, the soil was found to be 58% sand, 22% silt, and 20% clay (Wee 2007). Organic matter and pH were found to be 2.11% and 6.5, respectively.

Rapid palladium catalyst deactivation was observed by Wee when treating the Quincy, Florida soil. The catalyst was severely deactivated by day one in the semi-continuous system, which severely limited the hydrodehalogenation reaction, effectively shutting down the system (Wee 2007). Little to no catalyst deactivation was observed when treating the College Station, Texas soil. The results of the semi-continuous experiments led Wee to speculate the catalyst deactivation occurred due to the presence of organic matter (poisoning), although this was not confirmed.

2.4 Ultraviolet Degradation of Organic Matter

Dissolved organic matter (DOM) extracted from the soil is believed to be the cause of catalyst deactivation observed by Wee (2007) and myself in REACH semi-continuous experiments. Since catalyst deactivation is one of the main obstacles in preventing REACH from being used in the field, a solution must be found. As detailed above, many researchers focus on protecting the catalyst by coating or treating it to prevent poisons from reaching active sites. However, the coatings and treatments become less effective with age and eventually wear off of the catalyst.

I proposed to degrade the dissolved organic matter poisons by treating the solvent containing DOM with ultraviolet light. Although this was never attempted by previous researchers for the purpose of preventing catalyst deactivation, it is commonly known that ultraviolet light degrades organic matter in natural systems; this process is commonly known as 'photobleaching'. By passing ultraviolet light through a solution containing DOM, radicals are created and the DOM is subsequently oxidized. Brinkmann (2003), Moran and Zepp (1997), Frimmel (1998), and Munster et al. (1999) all observed that sunlight decreases the average nominal molecular weight of dissolved organic matter.

A number of researchers have observed both catalytic effects and inhibiting effects of dissolved metals present in solution where photobleaching is occurring. Brinkmann found that dissolved iron present in the solution serves as a catalyst and increases the rate of oxidation due to the creation of iron containing radical compounds (2003). Conversely, Cu(II) was found to inhibit the degradation of DOM by Kamiya and Kameyama (2001) and Liao et al. (2001). If ultraviolet treatment reduces catalyst activity loss, further research could focus on using dissolved metals to our advantage in adding the ultraviolet treatment process.

Chapter 3: Materials and Methods

The objective of this chapter is to define and describe the materials and methods used to conduct the experiments that support this thesis. I ran five basic types of experiments: (1) semi-continuous operation of a bench-scale REACH system with contaminated soil; (2) semi-continuous operation of a bench-scale REACH system with no soil but spiked with contaminant; (3) batch tests of catalytic treatment of contaminated solvent; (4) hydrogen batch tests of catalytic treatment of contaminated solvent; and (5) ultraviolet treatment of solvent as a potential means of preventing catalyst deactivation.

3.1 Materials (General Analysis)

The chemicals used to conduct this thesis research are listed in detail in Table 3.1 (next page). Palladium (Pd) catalyst was used for hydrodehalogenation in both batch and semi-continuous reactors; rhodium (Rh) catalyst was used for hydrogenation. All deionized water was obtained using a Thermo Scientific purification system in the lab.

Gases used for the operation of a PerkinElmer Clarus 500 gas chromatograph and for the catalytic conversion processes utilized in this thesis are hydrogen, compressed air, helium, and nitrogen. Table 3.2 (next page) summarizes their uses. All gas cylinders were obtained from Airgas in Tampa, FL.

Table 3.1 Chemical Specifications

Chemical Name	Details	Supplier
Deionized (DI) Water	18.2 MΩ×cm	Thermo Scientific purification system
Ethyl Alcohol (Ethanol)	99.5%, 200 proof ACS Reagent	Acros Organics
Pentane	98%	Acros Organics
Hexane	98.5%, HPLC Grade	EMD Chemicals
Cyclohexane	99+%, ACS Reagent	Sigma-Aldrich
Benzene	>99%, ACS Reagent	Sigma-Aldrich
Trichloroethylene (TCE)	99.5% minimum ACS Reagent	Sigma-Aldrich
1,2,4,5-Tetrachlorobenzene (TeCB)	98%	Sigma-Aldrich
Pd on Alumina Catalyst	5 wt. % on Al ₂ O ₃ , 3.2 mm pellets	Alfa Aesar
Rh on Alumina Catalyst	0.5 wt. % on Al ₂ O ₃ , 3.2 mm pellets	Sigma-Aldrich
Glass beads	3 mm borosilicate glass	Pyrex

Table 3.2 Gas Specifications and Use

Gas	Used
Hydrogen (99.999%)	Flame ionization detector fuel, catalytic conversion
Compressed air (20-22% O ₂)	Flame ionization detector fuel
Helium (99.999%)	Carrier gas
Nitrogen (99.999%)	Make-up gas for electron capture detection (ECD)

3.2 Contaminated Soil

To test the efficacy of the REACH system, I needed a supply of contaminated soil, so I contaminated 1.4 kg of Florida soil in the laboratory with 1,2,4,5-tetrachlorobenzene (TeCB). The target concentration of the soil is 100 mg TeCB per kg of dried soil. This concentration is typical of soil found on contaminated sites (Wee 2007).

3.2.1 Contamination Procedure

All materials and glassware were cleaned with soap and water. Gloves, splash goggles, and a lab coat were worn.

1.5 kg of uncontaminated Florida soil was weighed using a balance, scoop, and a small plastic container. The soil was then spread out onto foil and allowed to dry overnight. After drying, 700 g of soil was weighed and placed in an aluminum foil lined tumbler container (2 tumbler containers each with 700g of soil).

A stock solution of TeCB was prepared by dissolving 0.14 g of TeCB into 280 mL of acetone. 0.14g of TeCB was weighed on a hexagonal plastic plate using a balance. 280 mL of acetone was measured using a 250 mL graduated cylinder (200mL+80mL). The TeCB and acetone were added into a 600 mL beaker and mixed with a magnetic stirrer for 10 minutes.

140 mL of stock solution was added to each of the lined tumbler containers using a 25 mL graduated cylinder ($5 \times 25\text{mL} + 15\text{mL}$). After each addition was made, the container was sealed. The bottles were then mixed in a tumbler for 1 week. Once mixing was complete, the containers were removed from the tumbler and mixed with hand utensils for 10 minutes.

The contaminated soil was then poured onto clean plates under a fume hood, and the acetone was left to volatilize for 24 hours. The soil was then mixed together in a large plastic container for 10 minutes. 200g of contaminated soil was added to clean 250 mL amber-glass bottles. The 7 bottles were kept at room temperature for 3 months to age. Any remaining non-contaminated soil was discarded and all equipment was cleaned.

3.2.2 TeCB Concentration in Artificially Contaminated Soil

The “shaker” method (Wall and Stratton 1991), was conducted as follows to determine the TeCB concentration in the artificially contaminated soil.

First, three tubes each with 10-gram TeCB of contaminated soil were placed in 50 mL centrifuge tubes. Solvent for the “shaker” method was made by mixing 24 mL of hexane with 6 mL of acetone in a 50 mL graduated cylinder. Then 10 mL of solvent was added to the 50 mL

centrifuge tube. The tube was sealed and placed on a shaker table at 200 rpm for one hour. The tube was then centrifuged for 10 min at 10,000×g.

The supernatant was then collected and placed in a 50 mL volumetric flask. This was repeated twice with a fresh 10 mL of solvent. Volume of supernatant collected was recorded after each of the 3 washings. The supernatant of each sample was collected together and analyzed by the GC/ECD. The concentration of TeCB in the soil was determined to be 22.8 +/- 0.2 mg/kg, much less than the 100 mg/kg target value. The difference between target and actual concentration is most likely caused by errors in laboratory procedures.

3.3 Construction of the REACH System

To test the feasibility of the REACH technology, and thereby fulfill the objectives of this thesis, I constructed a bench-scale model of the proposed REACH remediation technology in the lab.

The bench-scale model is composed of a soil column, two Swagelok filters, a hydrogen diffusion module, two catalyst columns, and a solvent reservoir. A hydrogen pressure of approximately 10 psi was maintained in the system using a check valve. The model's components were connected with stainless steel tubing and a pump was used to circulate the water/ethanol solvent in a clockwise manner with respect to Figure 1.3. The catalyst columns were attached in series, with the palladium column first and the rhodium column second. Detailed component and part information is listed in Table 3.3 (next page). Figure 1.3 is located in Chapter one on page 4.

Table 3.3 REACH Detailed Component and Part Information (Wee, 2007)

Component	Manufacturer/Model
Soil Column	150 cm ³ stainless steel (304L) tubular cylindrical reactor
Filter	Swagelok tee-type, TF series, sintered filter media, 0.5 μm pore size
Hydrogen Diffusion Module	Membrana SuperPhobic mini-module
Solvent Reservoir	2.3 L glass bottle, three hole cap (PTFE with TFE/propylene O-ring and polypropylene screw collar)
Sample Port	Swagelok three-way valves, samples were collected using a Hamilton gas-tight syringe with a 16-gauge needle
Check Valve	Swagelok, 10 psig
Pump	Eldex Optos metering pump, model 2SM, operated at a 1 mL/min flow rate
Tubing	1/8" stainless steel; between the reservoir and pump 1/16" flexible plastic tubing by Eldex
Fittings	Stainless steel Swagelok, compression-type
Catalyst Columns	Swagelok stainless steel (316) miniature sample cylinder, 25 cm ³ internal volume

Following construction, the REACH bench-top model was cleaned thoroughly with a 50:50 mixture of water and ethanol. The solvent was prepared by first measuring 500 mL of DI water and 500 mL of ethanol using a graduated cylinder. The components were combined to make 1 L of 50:50 water/ethanol solvent (before mixing). The 50:50 solvent was then poured into the solvent reservoir, a magnetic stir bar was inserted, and the cap was screwed tight to prevent any evaporative losses. The solvent reservoir was placed on a magnetic stirrer and stirred to completely mix the solvent. The magnetic stirrer was on for the duration of the experiment. Solvent was then pumped through the system for 24 hours to clean it. All tube and column connections were then checked for leaks in an effort to minimize solvent losses.

3.4 First Experiments: Semi-Continuous Operation of REACH with Soil

200 g of contaminated Florida soil was weighed and placed into the soil column. The ends of the column were then securely fastened to the model to prevent solvent loss. 10 g of glass beads were then added to the catalyst columns. 2 g of palladium catalyst pellets were weighed and added to the Pd catalyst column. 8 g of rhodium catalyst pellets were added to the rhodium catalyst column. The remaining space in both columns were filled with glass beads. Hydrogen gas was then turned on to a pressure of 10 psi to allow diffusion into the solvent to be used in the catalytic processes. The pump was turned on and the solvent was allowed to completely circulate. In theory, the solvent would extract the TeCB from the contaminated soil, then hydrogen would be delivered to the contaminated solvent via the hydrogen diffusion module, and then the TeCB would be converted to cyclohexane in the catalytic reactors. The solvent is then returned to the reservoir in a closed loop, as seen in Figure 1.3.

The performance of the REACH system was determined by taking solvent samples from the sample ports shown in Figure 1.3 and analyzing them for the concentrations of TeCB, benzene, and cyclohexane. Initial (day 0) samples were taken as soon as the solvent made a complete loop around the system. Samples were then taken from every sample port in duplicate once per day for 7 days. The method for analyzing samples for TeCB, benzene, and cyclohexane is described in Section 3.10, below.

3.5 Second Experiments: REACH with Spiked Solvent (no soil)

A second experiment using REACH with spiked solvent was conducted to determine if the system could catalytically convert TeCB to cyclohexane if no soil was present. This would determine if the catalytic conversion step could work when deactivating compounds are not

present. Similarly to section 3.4, the REACH bench top model was first cleaned thoroughly for 24 hours with a 50:50 mixture of water and ethanol. The solvent was prepared by first measuring 1.1 L of DI water and 1.1 L of ethanol using a graduated cylinder, as described above.

The catalyst columns were both loaded with 10 g of glass beads, followed by 2 g of Pd catalyst in the Pd catalyst column and 8 g of Rh catalyst in the Rh catalyst column. The remainder of the columns were then filled with glass beads. The solvent reservoir was spiked with 11 mL of 2,000 mg/L TeCB stock solution to bring the concentration to 10 mg TeCB/L. The solvent reservoir was allowed to mix with the magnetic stirrer for 10 minutes. To remain consistent with the semi-continuous soil experiment, hydrogen gas was then turned on to a pressure of 10 psi to allow diffusion into the solvent to be used in the catalytic processes. The pump was turned on and the solvent was allowed to completely circulate. It is hypothesized that the TeCB will be almost completely converted to cyclohexane during the seven day test period, without incident, since no soil is present. Initial (day 0) samples were taken as soon as the solvent made a complete loop around the system. Samples were then taken from every sample port in duplicate once per day for 7 days.

3.6 Third Experiments: Batch Testing of Catalyst Activity

3.6.1 Catalyst Deactivation Batch Reactor Experiment Procedure

A Parr 3911 hydrogenation apparatus batch reactor was used to determine if the catalyst in the semi-continuous REACH model had been deactivated, and if so, if the activity could be restored. Two experiments were conducted to determine this. 300 mL (before mixing) of a 50:50 water/ethanol solvent was added to the reaction vessel. In one test, cleaned REACH catalyst was

used; the other test used uncleaned REACH catalyst. The procedure for cleaning catalyst is described in section 3.6.2.

A previously prepared 2,000 mg/L TeCB in 50:50 water/ethanol solvent solution was used to spike the batch reactor. 1508 μ L were added to reach a target concentration of 10 mg TeCB/L of solvent. The contents were then shaken to ensure complete mixing, and samples were taken to determine the initial TeCB concentration. 0.2 g of palladium catalyst from the REACH reactor and 0.9 g of rhodium catalyst from the REACH reactor were then weighed and placed into the reaction vessel. The procedure for making the 2,000 mg/L TeCB solution can be found in section 3.10.

To prevent contamination, the hydrogen storage tank on the batch reactor was vented three times. The vessel was then securely inserted into the batch reactor, and the headspace was vented three times with hydrogen gas to ensure all air was removed. The container was then pressurized to 10 psi, and the hydrogen reservoir was opened to the reaction vessel to maintain a nearly constant pressure. The shaker was turned on for 8 hours. Once the experiment was complete, the shaker was stopped and final samples were taken in duplicate. The samples were analyzed using the GC to determine if the catalyst was active. If the catalyst was active, then the spiked TeCB should have been converted to cyclohexane. If the catalyst had been deactivated during the REACH operation, then the TeCB would remain unconverted.

3.6.2 Catalyst Cleaning Method

Spent catalyst was cleaned using a method used by Wee (2007), adopted from Lowry and Reinhard (2000). The catalyst was placed in a 50 mL beaker, and the beaker was then filled with 20 mL of a 10% sodium hypochlorite solution. The catalyst was then swirled in the beaker for five minutes. After five minutes, the bleach solution was decanted and the process was repeated

two additional times. The beaker was then filled again with 20 mL of 10% sodium hypochlorite solution and was allowed to sit for ten minutes. The catalyst was then removed and thoroughly washed with DI water.

3.7 Fourth Experiment: Test of Hydrogen Delivery

A hydrogen delivery batch experiment was conducted to rule out lack of hydrogen delivery as an inhibitor to the reaction occurring in the semi-continuous system.

First, 300 mL of solvent from the semi-continuous REACH system was withdrawn from the solvent reservoir and placed into the batch reaction vessel. This solvent was from after the spiked solvent experiment (Section 3.5). Initial solvent samples for measurement of TeCB and benzene/cyclohexane concentrations were taken at this time. Samples were analyzed using the procedures described in 3.10. Next, 0.2467 g of fresh Pd catalyst and 0.8846 g of fresh Rh catalyst was placed into the reaction vessel. The hydrogen reservoir was then flushed three times with hydrogen gas. The reaction bottle was then attached to the shaker and the bottle headspace was flushed three times. The system was pressurized to 10 psi and the shaker was turned on for 8 hours.

After the 8 hour time period was finished, samples for TeCB and benzene/cyclohexane were taken in duplicate. Solvent was filtered prior to being placed into sample vials to prevent metal flakes from entering the sample. The samples were then analyzed by the GC. If the solvent from the reactor contained dissolved H₂ gas, TeCB would be converted. If no H₂ was present in the solvent, then the TeCB would not be converted.

3.8 Fifth Experiment: Ultraviolet Treatment of Solvent

It has been hypothesized that dissolved organic matter is the primary compound responsible for catalyst deactivation seen in REACH (Wee 2013). Ultraviolet radiation has been documented to be able to degrade organic matter in natural bodies of water (Brinkmann 2003). An ultraviolet solvent treatment experiment was conducted to determine if UV is a viable treatment method for preventing catalyst deactivation by degrading the organic matter extracted from the soil. . It is possible that UV treatment of the solvent downstream of the soil column (where NOM is hypothesized to dissolve) but upstream of the catalyst column (where NOM is hypothesized to deactivate the catalyst) would protect the catalyst from NOM-induced deactivation.

3.8.1 Extraction of Organic Matter from Soil

To recreate semi-continuous experiment laboratory conditions as closely as possible, organic matter was extracted from clean Florida soil (the same soil type that was used in the semi-continuous soil experiment). First, 55 g of uncontaminated Florida soil was combined with 0.6 L (before mixing) 50:50 water/ethanol solvent mixture in a glass jar. The glass jar was then placed on a Lortone tumbler from Mukilteo, WA, placed in the dark to mitigate photo-degradation, for 72 hours.

After 72 hours had elapsed, the solvent was poured out of the glass jar, and filtered through a paper towel to remove any large soil particles. The solvent was then pumped through a 0.5 μm filter to remove small particles. The filtered solvent was then stored in amber glass bottles in a closed cabinet.

3.8.2 UV Solvent Treatment / Catalyst Preparation

After filtering, the solvent was treated with an ultraviolet light to breakdown natural organic matter. To do this, the recovered solvent (360 mL) was poured into a 500-mL graduated cylinder and mixed with a metal spoon. Half of the solvent was poured back into amber glass vials, the other half was poured into a clear Erlenmeyer flask. The flask was then capped with parafilm to prevent evaporative losses. The solvent in the flask was placed on top of an ultraviolet light inside a sealed cabinet for 24 hours. The ultraviolet light was positioned so the solvent received an ample amount of light.

Clean Pd catalyst was then prepared for the batch experiment. First, 0.2 g of palladium catalyst was weighed and placed into both amber glass solvent bottles. Each bottle was slowly shaken on a shaker table to mix the catalyst with the solvent solution for 24 hours. Care was given to ensure the speed was enough to turn the catalyst without chipping metal flakes off. A 24 hour shake time was selected to allow the catalyst to become completely deactivated if it was possible. Both solvent solutions were then removed and used during the UV batch experiment.

3.8.3 UV Solvent Treatment Batch Reactor Procedure

Once the solvent samples were prepared and the catalyst was pre-equilibrated with the solvent, the first batch experiment was started. Two samples of solvent were taken out of the amber glass solvent bottles to measure initial TeCB concentration in the solvent. The hydrogen reservoir of the Parr batch reactor was then flushed three times to prevent contamination. The solvent and catalyst mixture was poured into the batch reactor bottle, and the bottle was hooked up to the shaker. Remaining headspace in the reaction bottle was flushed three times to eliminate air. The system was pressurized with hydrogen to 10 psi and the reactor was turned on for 8 hours.

After 8 hours elapsed, the reactor was turned off and depressurized. The reaction bottle was removed and samples for TeCB and benzene were taken with a plastic syringe. The solvent was filtered with a Whatman 934-AH glass microfiber (24 mm diameter) syringe filter to prevent catalyst flakes from contaminating the sample. The samples were then analyzed. This procedure was repeated for the second bottle of solvent. If the UV treatment broke down organic matter and thereby prevented catalyst deactivation, complete conversion from TeCB to cyclohexane would be observed.

3.8.4 Color Spectrophotometer Test

A color spectrophotometer test was conducted to get an estimation of how effective the ultraviolet treatment was at breaking down natural organic matter in the solvent. An absorbance of 365 nm wavelength was used to determine the presence of organic matter, since it is a common measure used in the literature.

Four plastic sample vials were cleaned for use in the color spectrophotometer absorbance test. Once cleaned, two vials were filled with 1 mL of treated solvent were. The other two vials were fill with untreated solvent. Each sample was ran and its absorbance readout was recorded.

3.9 Sampling Procedure during REACH Operation

During operation of the REACH system (sections 3.4 and 3.5), samples were taken from the sample ports using a glass syringe for GC analysis. When a sample was taken, the syringe was screwed onto the sample port, and the valve was turned on the three-way sample port to allow the solvent to flow into the syringe. After the 1 mL syringe was filled, the valve was closed and the syringe was disconnected. The 1 mL sample was discharged into a 5 mL glass vial. This procedure was repeated once more to fill the glass vial with 2 mL of solvent. After 2 mL of

solvent were transferred to the vial, the cap was tightly secured to mitigate losses due to volatilization. The sample was labeled and the time was recorded. Solid caps were used for TeCB samples, while open caps were used for benzene/cyclohexane samples (One 2-mL sample for TeCB and one 2-mL sample for benzene/cyclohexane).

Once all samples were taken, 2 mL of pentane stock solution were added to each TeCB sample vial using a plastic pipet. The vials were sealed with caps and placed on a shaker table at speed 4 for one hour. Once one hour had elapsed, samples destined for TeCB analysis were allowed to sit for one hour, while benzene/cyclohexane samples were allowed to sit for 24 hours.

3.10 Gas Chromatograph Methods

3.10.1 GC Overview

A PerkinElmer Clarus 500 gas chromatograph (GC) equipped with a flame ionization detector (FID) and an electron capture detector (ECD) was used to measure concentrations of TeCB, benzene, and cyclohexane. For this thesis, a HP-5 GC capillary column was used for the ECD analysis and a RTX-1301 GC capillary column was used for the FID analysis. All methods used in this thesis to analyze TeCB, benzene, and cyclohexane samples were developed by Osborn (2011) and refined by Cone (2013). A detailed outline of the GC analysis methods can be found in the appendices of Cone (2013). Table 3.4 lists specifications of the GC columns used.

Table 3.4 Gas Chromatograph Capillary Column Specifications

Column Name	Stationary Phases	Column Dimensions (Length, Internal Diameter, Film Thickness)	Supplier
HP-5	(5 %-phenyl)- methylpolysiloxane	30 m, 0.32 mm, 0.25 μ m	J&W Scientific
RTX- 1301	6 % cyanopropyl phenyl, 94 % dimethyl Polysiloxane	30 m, 0.53 mm, 3.0 μ m	Restek

3.10.2 GC Analysis of TeCB

TeCB stock solution was prepared by weighing 40 mg 1,2,4,5-tetrachlorobenzene and placing it into a 20 mL glass vial. 20 mL of ethanol was added to the glass vial using a 20 mL glass pipet. The vial was sealed with a screw-on cap and placed on a shaker table at a moderate speed. The solution was allowed to mix for 24 hours. The target concentration of this stock solution was 2,000 mg TeCB/L. It can be stored in a chemical refrigerator for 2 weeks (Osborn 2011).

Serial dilutions of the stock solution were performed to create standards of known concentrations of TeCB; the standards of known concentration were analyzed via GC/ECD to create a calibration curve. 100 μ L of TeCB stock solution was added using a plastic pipet to an empty 20 mL glass vial. 10 mL of DI water and 9.9 mL of ethanol were then added to the jar, and the resultant solution was shaken by hand for 30 seconds to ensure complete mixing. Similar processes were repeated to make solutions with a TeCB concentration of 0.1, 0.5, 1.0, 5.0, and 10 mg/L. This process was completed in duplicate.

Ten 5-mL glass vials were cleaned and dried. After being clearly labeled, they were filled with 2 mL of each TeCB serial dilution using a glass pipet. 2 mL of pentane, spiked with 3.61 mg/L TCE as an internal standard, were then added to each vial. The vials were then sealed with closed caps and placed on the shaker table at a low/moderate speed for 1 hr. After 1 hr, the vials were removed and allowed to sit for 24 hr to allow for the TeCB to reach an equilibrium between the water-ethanol solvent and pentane. Once equilibrium had been established, 1 mL of pentane was carefully extracted from each vial using a pipet and transferred into a GC vial. The GC vials were placed into the autosampler of the GC and analyzed by GC/ECD.

The chromatogram was then used to find peak areas of each of the chemicals. The peak areas for TCE and TeCB were recorded. TCE was the internal standard used for this analysis. After peak areas were found, the ratio of TeCB to TCE was plotted against the known concentrations of TeCB in the water-ethanol solvent to create a calibration curve. An example of a TeCB calibration curve can be found in Figure 3.1. Calibration curves can be used to determine concentrations of TeCB in samples where the concentration is initially unknown.

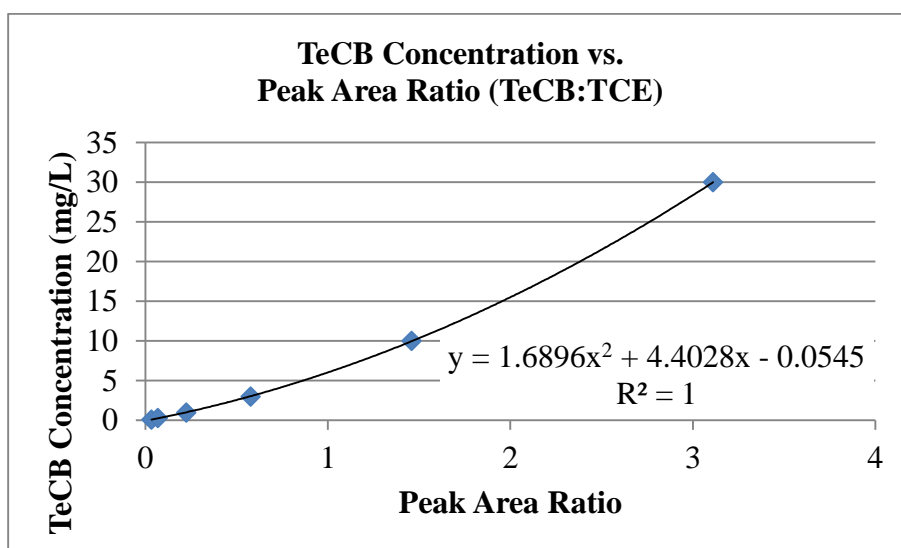

Figure 3.1 Calibration Plot for TeCB

3.10.3 GC Analysis of Benzene/Cyclohexane

A benzene/cyclohexane stock solution was then prepared. The concentration of benzene was 1746 mg/L and the concentration of cyclohexane was 1550 mg/L.

100 mL of ethanol was measured using a glass pipet and transferred into an amber glass jar. 200 μ L of benzene and 200 μ L of cyclohexane were then added to the amber glass jar using a plastic pipet. The stock solution was swirled by hand to minimize volatilization losses. The resulting stock solution has a 2,000 μ L/L concentration of benzene and cyclohexane with a shelf life of one week if stored in a chemical refrigerator (Osborn 2011).

Serial dilutions of the stock solution were performed to create standards of known concentrations of benzene/cyclohexane; the standards of known concentration were analyzed via GC/FID to create a calibration curve. 117 μ L of the benzene/cyclohexane stock solution was added using a plastic pipet to an empty 20 mL glass vial. 9.117 mL of DI water and 9 mL of ethanol were then added to the jar, and the resultant solution was gently swirled to ensure complete mixing. Serial dilutions were done to make solutions with a benzene concentration of approximately 0.1, 0.56, 1.12, 5.6, and 11.2 mg/L and a cyclohexane concentration of approximately 0.1, 0.5, 1.0, 5.0, and 10.0 mg/L. This process was completed in duplicate.

10 5-mL glass vials were cleaned and dried. After being clearly labeled, they were filled with 2 mL of serial dilution (listed above) using a glass pipet. The vials were then sealed with open caps (with septa) and placed on the shaker table at a low/moderate speed for one hour. After one hour, the vials were removed and allowed to sit for one additional hour to allow for the benzene and cyclohexane to reach an equilibrium between the solvent and headspace.

Once equilibrium had been established, 1 mL of headspace was carefully extracted from each vial using a gas-tight syringe and injected into the GC/FID. At the end of the 15 minute run-time, a chromatogram was generated.

The chromatogram was then used to find peak areas of each of the chemicals. The peak areas for ethanol, benzene, and cyclohexane were recorded. Ethanol was the internal standard used for this analysis. After peak areas were found, the ratio of benzene or cyclohexane peak areas to ethanol peak areas were plotted against the known concentrations to create a calibration curve. An example of a benzene and cyclohexane calibration curve used to determine benzene/cyclohexane contaminant concentrations can be found in Figure 3.2 and Figure 3.3, respectively.

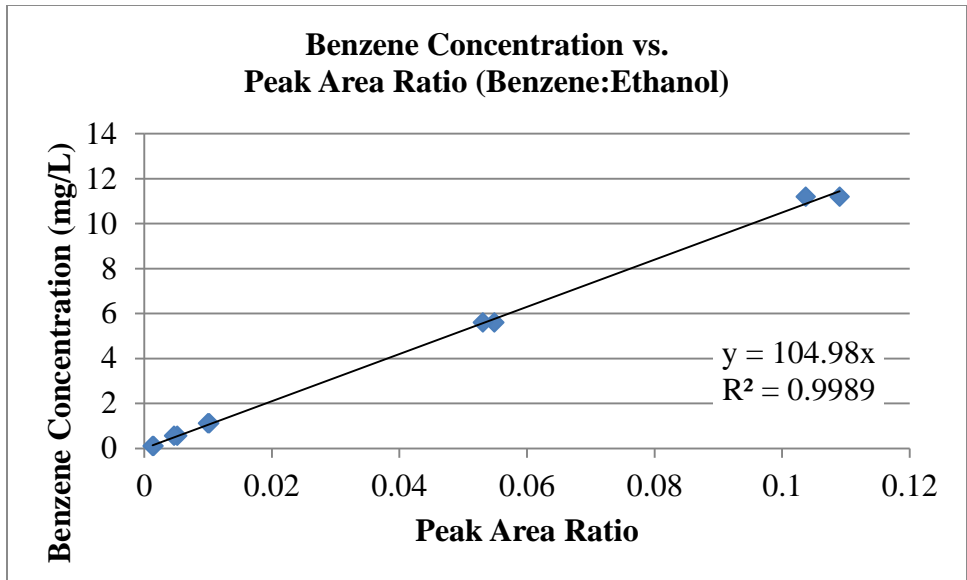

Figure 3.2 Calibration Plot for Benzene

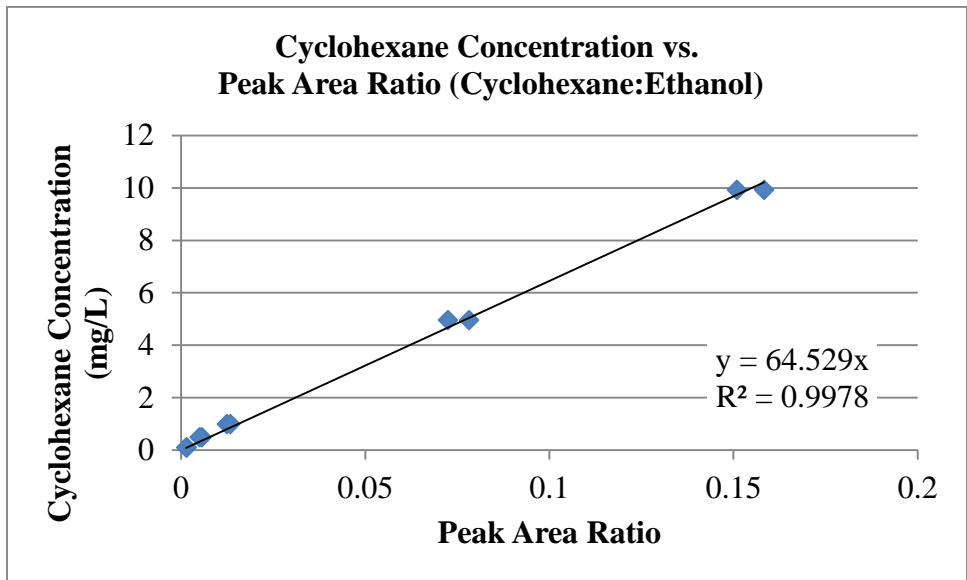

Figure 3.3 Calibration Plot for Cyclohexane

Chapter 4: Results and Discussion

The objectives of this section are to discuss and analyze the results from the two semi-continuous experiments, two batch experiments, and the UV experiment.

4.1 First Experiments: Semi-Continuous Operation of REACH with Soil

The REACH experiment with contaminated soil determines the effectiveness of the REACH semi-continuous bench-scale model at extracting TeCB from artificially contaminated soil and converting it to cyclohexane. Palladium and rhodium catalysts are used to dehalogenate TeCB to benzene and to convert benzene to cyclohexane, respectively. 2.2 L of 50:50 water/ethanol solvent was used with a hydrogen pressure of 10 psi.

Measured molar concentrations of TeCB, benzene, and cyclohexane for the semi-continuous REACH soil are plotted below in Figures 4.1-4.4. Samples taken directly after the soil column are shown in Figure 4.1, and samples taken after the Pd and Rh catalyst column are shown in Figure 4.2 and Figure 4.3, respectively. Figure 4.4 shows concentrations in samples taken from the solvent reservoir.

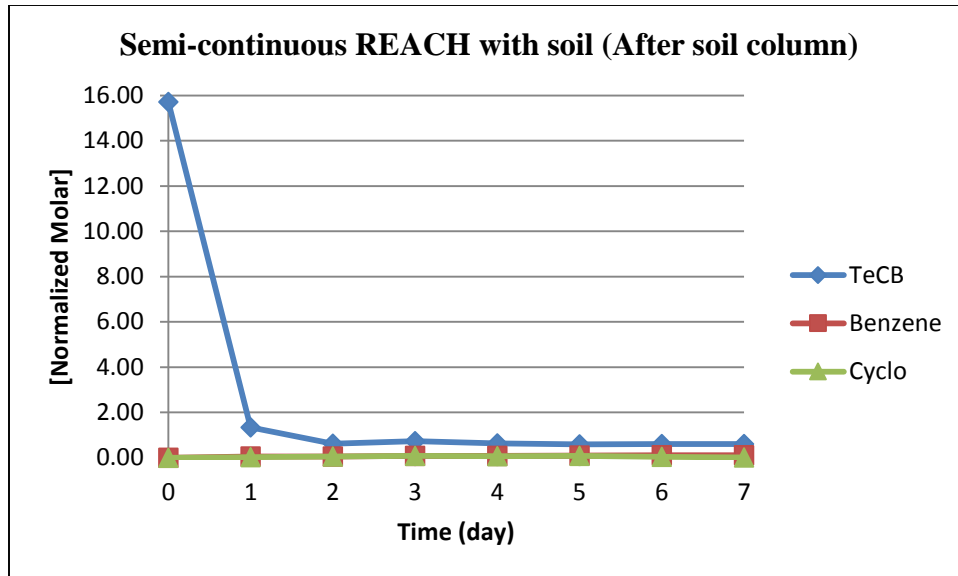

Figure 4.1 One Week Concentration Plot of REACH (after soil column). Soil was artificially contaminated.

Figure 4.1 shows normalized molar concentrations of TeCB, benzene, and cyclohexane plotted against time (in days). The normalized molar concentration for each chemical was determined by first calculating the hypothetical molar TeCB concentration, C_0 , that would result if all the TeCB in the soil were instantaneously transferred to the solvent.

$$C_0 = M_{\text{soil}} \times q_{\text{soil}} / V_{\text{solvent}} \quad (1)$$

Then, measured concentrations (in moles/L) were normalized by C_0 to yield the concentrations that are shown in Figures 4.1-4.4.

By examining Figure 4.1 above, it is observed that a large amount of TeCB is quickly extracted from the soil at the system start, since the normalized molar concentration of TeCB just downstream of the soil column is 15.71 at day 0. By day 1, normalized TeCB concentrations dropped to 1.34, indicating that a large amount of TeCB was already extracted from the soil. From days 2-7, a normalized TeCB concentration of around 0.60 was recorded. By day 2, benzene and cyclohexane had reached a normalized concentration of approximately 0.10, and remained constant for the rest of the experiment. This result led me to believe both

hydrodehalogenation and hydrogenation reactions had drastically slowed or stopped, since benzene did not fully convert to cyclohexane and since TeCB did not fully convert to benzene. The 20% loss of chemicals in the experiment could be due to TeCB not being completely extracted from the soil, absorption onto the stir bar or catalyst, volatilization, and/or errors in concentration measurements. Losses were calculated by adding together the normalized molar concentrations of each contaminant, then subtracting that number from 1.

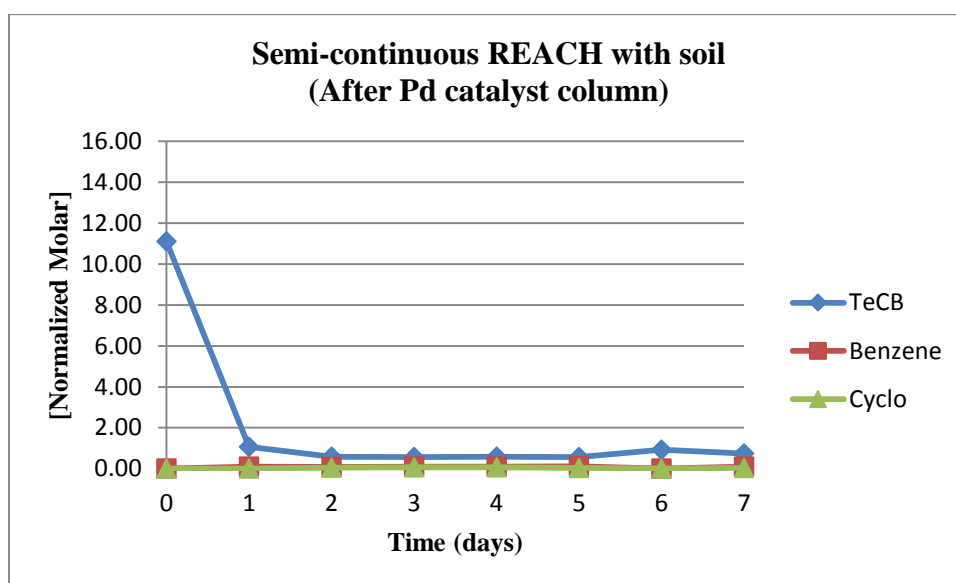

Figure 4.2 One Week Concentration Plot of REACH (after Pd column). Soil was artificially contaminated.

Figure 4.2 shows normalized molar chemical concentrations directly after the Pd catalyst column. After the day 0 TeCB extracted from the soil passed through the palladium catalyst column, the concentrations dropped from 15.71 (as seen on day 0 in Figure 4.1) to 11.11 (as seen on day 0 in Figure 4.2). This decrease suggests the TeCB dispersed throughout the solvent shortly after startup. The TeCB concentrations stabilized at around 0.6 for the remainder of the experiment, suggesting hydrodehalogenation ceased shortly after start up in the first 48 hours.

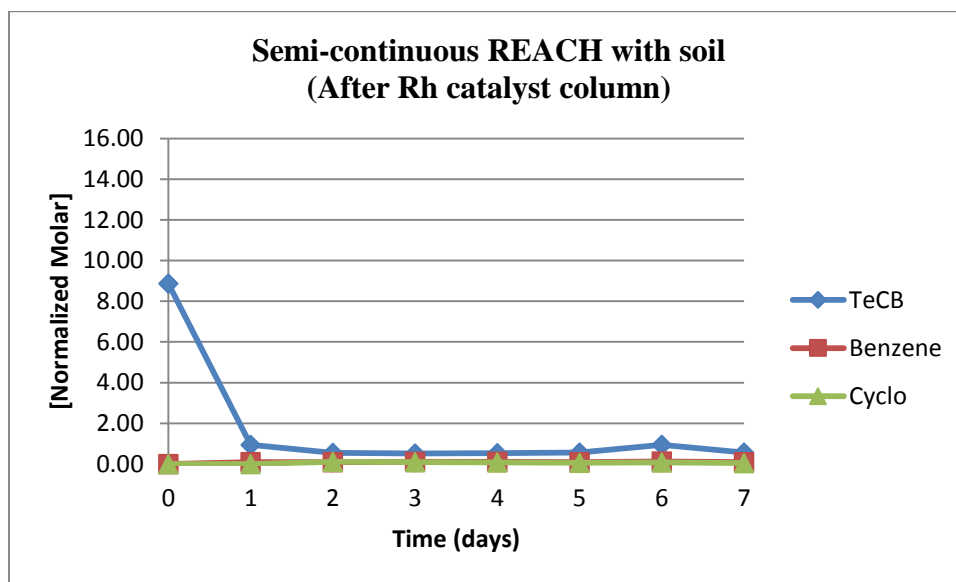

Figure 4.3 One Week Concentration Plot of REACH (after Rh column). Soil was artificially contaminated.

Figure 4.3 shows normalized molar chemical concentrations directly after the Rh catalyst column. After the day 0 TeCB extracted from the soil passed through the palladium catalyst column, the normalized concentrations dropped from 11.11 (measured after the Pd column, as seen on day 0 in Figure 4.2) to 8.87 (as seen on day 0 in Figure 4.3). This decrease suggests some hydrodehalogenation occurred over the Rh catalyst, which was largely unexpected. Agreeing with Figures 4.1 and 4.2, normalized TeCB concentrations stabilized at around 0.6 for the remainder of the experiment.

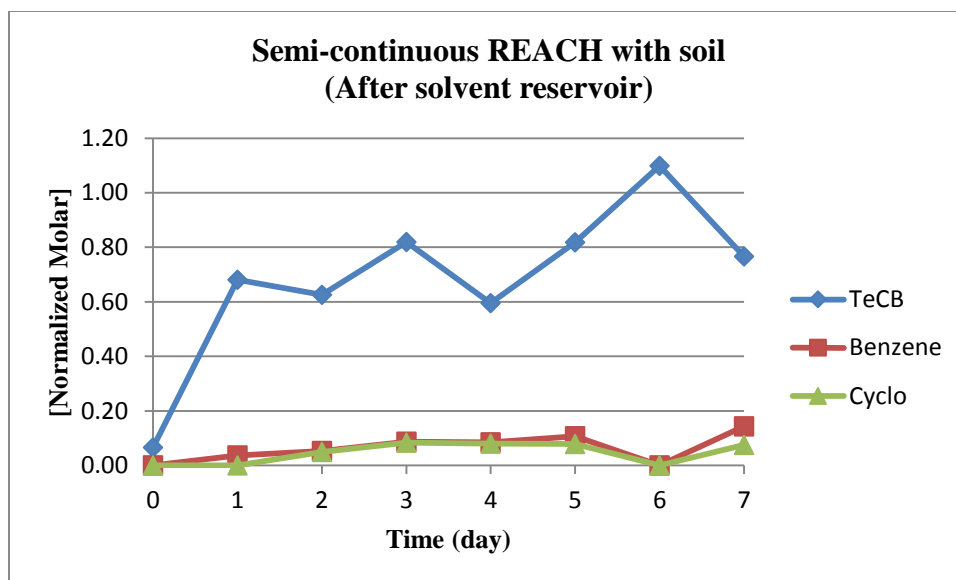

Figure 4.4 One Week Concentration Plot of REACH (after solvent reservoir). Soil was artificially contaminated.

Samples taken from the solvent reservoir are plotted above in Figure 4.4. This figure gives a clear visual representation of the reactor performance over the length of the experiment. TeCB starts at a concentration near 0 for day 0, then sharply increases to approximately 0.6-0.8; this TeCB concentration stabilizes for the remainder of the experiment, suggesting catalytic hydrodehalogenation ceased in as little as 48 hours. Benzene and cyclohexane slowly formed and stabilized at normalized concentrations around 0.1. Benzene was still measured at the end of the experiment, which suggests the hydrogenation reaction in the rhodium catalyst column also effectively stopped. Losses of about 10-20% could have been due to volatilization, absorption, or errors in measurement. Losses were calculated by adding the normalized molar concentrations of each contaminant, and subtracting that number from 1. Day 6 samples most likely have a measure error due to problems extracting GC peak areas. This measurement error could have been caused by sample contamination.

Figure 4.4 proves that REACH system could extract and convert TeCB to cyclohexane, but the reaction was limited. One hypothesis of why complete conversion was not achieved is that chemicals leached from the soil deactivated the catalyst. Wee (2007) also observed catalyst deactivation when he build and decontaminated a Florida soil using a past version of the REACH technology. A second hypothesis is that a hydrogen delivery problem was limiting the reaction rate. To reduce the chances of this reaction problem reoccurring, a second experiment was conducted using no soil and a TeCB spiked solvent reservoir, as described in section 3.5.

4.2 Second Experiments: REACH with Spiked Solvent (no soil)

The REACH with spiked solvent (no soil) experiment determines the effectiveness of the REACH semi-continuous bench-scale model at converting TeCB to cyclohexane without the interference of soil. Like the REACH experiment with soil, palladium and rhodium catalysts are used to dehalogenate TeCB to benzene and to convert benzene to cyclohexane, respectively. 2.2 L of 50:50 water/ethanol solvent was used with a hydrogen pressure of 10 psi. No duplicates were performed during this experiment.

Measured molar concentrations of TeCB, benzene, and cyclohexane for the semi-continuous REACH with TeCB spiked solvent are plotted below in Figure 4.5. Samples taken directly after the solvent reservoir are shown in Figure 4.5.

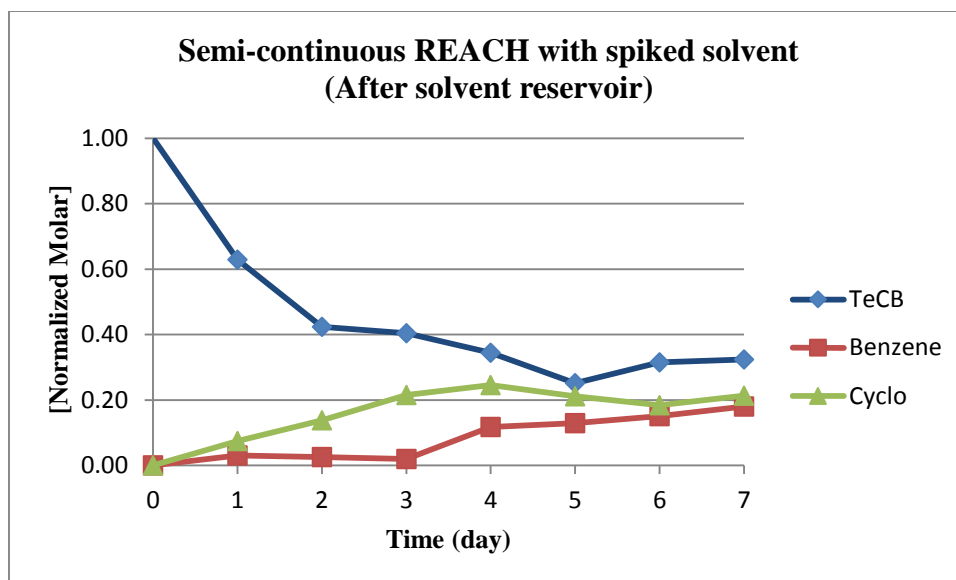

Figure 4.5 One Week Concentration Plot of REACH (with spiked solvent). Samples taken from solvent reservoir.

Tetrachlorobenzene, benzene, and cyclohexane samples taken directly after the solvent reservoir are plotted in Figure 4.5. Normalized concentrations are calculated by dividing the measured concentration by the spiked solvent reservoir concentration. TeCB made a steady decrease over the seven day timespan, stabilizing at a normalized concentration around 0.3 near day 4. This suggests hydrodehalogenation was proceeding better than in the soil experiment but the catalyst's activity was significantly reduced by day 2. Hydrogenation seemed to work rather well until days 3-4. Almost all benzene was converted to cyclohexane before it reached the solvent reservoir in the first three days. On day 4, moderate levels of benzene were measured in the solvent reservoir, suggesting the rhodium catalyst was deactivated by day 4. By day 7 TeCB concentrations were at 0.3, benzene 0.2, and cyclohexane 0.2. Losses of 30% could have been caused by measurement error, volatilization, or absorption onto the catalyst or stir bar. Losses were calculated by adding the normalized molar concentrations of each contaminant, and subtracting that number from 1.

Figure 4.5 shows that REACH reactor performed better when soil was not present, suggesting REACH could be a viable technology if catalyst deactivation is prevented. However, it is surprising that the system did not fully convert the TeCB to cyclohexane. Three possible explanations for the incomplete conversion are: (1) a trace amount of NOM was still present in the system from the REACH semi-continuous system with soil experiment (despite the system being thoroughly cleaned), (2) there was a hydrogen delivery problem, and/or (3) chloride ion formed from the dehalogenation step is an important deactivating compound. Deactivation by chloride does not seem to be consistent with the findings of Wee (2007), but it could explain why the catalyst deactivated with no soil present.

4.3 Third Experiments: Batch Testing of Catalyst Activity

It was hypothesized (Section 4.1) that complete conversion was not achieved in the semi-continuous experiment with soil because of catalyst deactivation. To test this hypothesis, two 8-hour batch experiments were conducted using the spent catalyst from the experiment.

In the first batch experiment, untreated spent catalyst taken directly from the REACH reactor was used. In the second, the spent catalyst was cleaned with a 10% bleach solution to remove any chemicals which could deactivate the catalyst (Lowry and Reinhard 2000) (Wee and Cunningham 2011). In these experiments, the parameters of batch experiments by Cone (2013) were replicated by using a 50:50 water/ethanol solvent, 0.25 g of Pd catalyst, 0.90 g of Rh catalyst, and an 8-hour runtime to allow for complete conversion of TeCB to cyclohexane. The results of these batch experiments are summarized below in Table 4.1.

Table 4.1 Catalyst Deactivation Batch Experiments

Catalyst	Initial TeCB (mM)	Mass of Pd Catalyst (g)	Mass of Rh Catalyst (g)	Final TeCB (mM)	Final Benzene (mM)	Final cyclohexane (mM)	Total Mass Balance Recovered (%)
cleaned	0.0405	0.2505	0.9143	0.0040	0.0052	0.0259	87
not cleaned	0.0379	0.2462	0.8896	0.0239	0.0027	0.0042	81

As seen in Table 4.1, the catalyst deactivation batch experiment supports the hypothesis that the reaction in the semi-continuous reactor with soil ceased due to catalyst deactivation. This is clear from the conversion percentages seen. In the experiment with unregenerated catalyst, over 60% of the initial TeCB remained unreacted. In the cleansed spent catalyst experiment, over 75% of the TeCB was converted. These numbers show clearly that the catalyst in the semi-continuous REACH system had lost its catalytic activity, but that the deactivation was reversible. The loss of catalytic activity is consistent with the hypothesis that poor performance of the semi-continuous REACH system was due principally to catalyst deactivation. The presence of roughly 10% unreacted TeCB in the first experiment suggests that cleaning the catalyst may not have fully recovered its activity. The 25-30% of TeCB converted in the uncleaned experiment could possibly be caused by metal flakes being knocked off the catalyst surface, exposing new active catalyst sites that could react with the contaminants. REACH with spiked solvent (no soil) also did not perform as well as expected.

4.4 Fourth Experiment: Test of Hydrogen Delivery

In the catalyst deactivation batch experiment, only 70% of TeCB was destroyed when it was expected to near complete destruction in seven days. Because the system did not contain

soil, I did not think it likely that catalyst deactivation was the cause of the worse-than-expected performance. Therefore, to check if a hydrogen delivery problem was contributing to the poor performance, a hydrogen delivery batch experiment was conducted.

An 8-hour batch experiment was conducted to determine if the slowed reaction rate observed in both semi-continuous experiments was not caused by a hydrogen delivery problem. In this experiment, used solvent was taken from the semi-continuous system (after the semi-continuous experiment with spiked solvent was conducted). Catalyst was taken from the system to be used as the catalyst and the batch reaction vessel was filled with hydrogen. If conversion of TeCB to benzene and cyclohexane occurred in the batch reactor, it would indicate that the catalyst was still active, and it would suggest that the poor performance in the semi-continuous system was caused by lack of hydrogen delivery. Initial and final molar concentrations of tetrachlorobenzene are shown below in Table 4.2.

Table 4.2 Summary of Hydrogen Delivery Batch Experiments

Time (hour)	[TeCB] (μM)
0	6.24
8	3.88

The results from Table 4.2 show that, even in the presence of abundant hydrogen, the catalyst was not able to fully destroy TeCB. In an 8-hr time period, only 62% of TeCB was removed. This suggests that the catalyst had been deactivated, even though there was no soil present in the semi-continuous system. Therefore, it seems that the poor performance of the semi-continuous system was probably caused by catalyst deactivation, not by lack of hydrogen delivery. It is hypothesized that deactivation occurred, even though there was no soil in the soil column, because of a residual amount of the deactivating chemical was still in the system. The

observed drop in TeCB levels was most likely caused by catalyst flakes created in the reactor when it was shaken.

4.5 Fifth Experiment: Ultraviolet Treatment of Solvent

Ultraviolet solvent treatment batch tests were conducted to determine whether UV treatment was a viable method to help reduce catalyst deactivation in the semi-continuous system. It is possible that UV pretreatment of the solvent downstream of the soil column (where NOM is hypothesized to dissolve) but upstream of the catalyst column (where NOM is hypothesized to deactivate the catalyst) would protect the catalyst from NOM-induced deactivation. Therefore, in this test, organic matter was extracted from soil into a 50:50 water/ethanol solvent. The solvent was divided in half. One sample of solvent was treated with UV in an effort to remove organic matter, and one was left as a control. Two batch experiments were then conducted to determine if there was any difference in catalyst activity. Table 4.3 summarizes the results of this experiment.

Table 4.3 UV Solvent Treatment Batch Experiments Summary

Solvent	Spectrometer @ 365 nm (mV) Absorbance	Fraction of TeCB removed (%)
UV Treated Solvent	0.569	51%
Untreated Solvent	0.698	47%

From examining Table 4.3, it is clear that treating the solvent with ultraviolet light did not have a major impact on catalyst deactivation. In the UV treated solvent experiment, 51% of TeCB was converted to benzene. In the untreated experiment, 47% was converted to benzene.

The small difference in conversion is not profound enough to prove the technology works and is within the normal variation seen in batch experiments (Cone 2013). Therefore, adding a UV treatment module to the REACH system downstream of the soil column is not likely to prevent catalyst deactivation.

4.6 Discussion and Implications

Previous batch experiments by Cone (2013) and Osborn (2011) proved that nearly 100% of TeCB in a 10 mg/L solution of 50:50 water/ethanol could be converted to cyclohexane in 8 hours. Wee also found that a semi-continuous reactor could successfully extract and convert 90% TeCB to benzene in 7 days with an initial soil concentration of 200 mg TeCB/ 1 kg soil (2007). Resolving the catalyst deactivation issue could increase the percent of TeCB converted to cyclohexane over a 7-day period, making REACH a viable green remediation technology.

Future work should focus primarily on methods to prevent catalyst deactivation, either via a coating, embedding chemicals in the catalyst, or pretreatment of the solvent. When this obstacle is surpassed, additional semi-continuous experiments with spiked solvent and contaminated soil should be conducted to prove REACH works. Once the technology is proven to work on TeCB, other HHOCs and combinations of HHOCs should be investigated.

Chapter 5: Conclusion

To address the short-comings of traditional solvent extraction technique, Wee and Cunningham (2008, 2011, 2013) introduced remedial extraction and catalytic hydrodehalogenation, or REACH. REACH is a 'green' soil remediation technology for destroying HHOCs that eliminates secondary waste streams. REACH uses solvent extraction coupled with catalytic halogenation to convert halogenated organic compounds to less harmful chemicals. The REACH process is considered to be semi-continuous since the water/ethanol solvent is continuously flowing, but the soil is treated in individual batches in a stationary soil column (Wee and Cunningham 2011, 2013).

Previously, REACH has been proven to convert 1,2,4,5-tetrachlorobenzene (TeCB) to benzene in both batch and semi-continuous experiments using a palladium-on-alumina catalyst (Wee and Cunningham 2011, 2013). In semi-continuous experiments Wee and Cunningham (2011) achieved over 90% extraction and conversion of TeCB to benzene in 1 week.

Benzene, however, is still toxic, and is likely not an acceptable end product in most applications. To address this, catalytic hydrodehalogenation of TeCB has been combined with catalytic hydrogenation of benzene to cyclohexane, a benign end product (Osborn 2011; Ticknor 2012; Cone 2013). Previous experiments by Osborn (2011), Ticknor (2012), and Cone (2013) proved that it is possible to convert TeCB to cyclohexane in a batch process using both palladium and rhodium catalysts. Cone (2013) demonstrated that in a batch reactor, TeCB in a solution of water and ethanol could be converted nearly 100% to cyclohexane in 8-12 hours.

However, thus far, no one has demonstrated palladium and rhodium can be used in a semi-continuous REACH process like that of Wee and Cunningham (2011).

The objective of this thesis is to aid in the development of remedial extraction and catalytic hydrodehalogenation (REACH), a green remediation technology used to remove and destroy halogenated hydrophobic organic compounds from soil. The extent to which the semi-continuous REACH reactor could extract and convert the model contaminant, 1,2,4,5-tetrachlorobenzene, to an acceptable end product, cyclohexane, was studied in this thesis. Two semi-continuous experiments were conducted to study this. The first used artificially contaminated soil to prove the bench top model could extract and convert TeCB to cyclohexane. The second used no soil and a TeCB-spiked solvent. Both experiments were conducted for one week using a 50:50 water/ethanol solvent, palladium and rhodium catalyst, and a 10 psi hydrogen pressure. Catalyst deactivation occurred to some extent in both semi-continuous experiments. Deactivation was confirmed by a batch test where catalyst was cleaned and in a batch test where the catalyst was not cleaned. A proposed method for mitigating catalyst deactivation using ultraviolet light was proposed and tested.

The REACH system successfully converted tetrachlorobenzene to cyclohexane in both semi-continuous experiments, suggesting the technology has the potential to work as intended. It is hypothesized that conversion was limited in both reactions because of catalyst deactivation caused by chemicals in the soil. Major deactivation occurred by the second day in both tests, which severely limited the reactor's ability to convert TeCB to cyclohexane in a reasonable time. It is clear that catalytic deactivation must be eliminated or mitigated for the technology to be financially viable for field use. It is hypothesized that catalyst deactivation occurred in the spiked

solvent experiment because trace amounts of the catalyst deactivating chemical remained in the system after cleaning.

Ultraviolet light solvent treatment was proposed as a technique to mitigate or eliminate catalyst deactivation. In this experiment, the solvent was treated with ultraviolet light in order to break down natural organic matter, a class of chemicals which is known to deactivate metal catalysts. Although some degradation of natural organic matter did occur during ultraviolet treatment, batch tests showed it was not enough of a decrease to have a significant impact on preventing deactivation. REACH could still prove technically feasible, but the deactivating chemicals must be identified, and means of controlling the deactivation must be developed.

References Cited

- Agency for Toxic Substances and Disease Registry (ATSDR), 2011. Substance Priority List. <<http://www.atsdr.cdc.gov/SPL/index.html>>
- Angeles-Wedler, D., Mackenzie, K., and Kopinke, F. "Sulphide-induced deactivation of Pd/Al₂O₃ as hydrodechlorination catalyst and its oxidative regeneration with permanganate." *Applied Catalysis B: Environmental*. 90 (2009): 613-617.
- Bartholomew, C. "Mechanisms of catalyst deactivation." *Applied Catalysis A: General*. 212 (2001): 17-60.
- Berube, M., Sung, B., Vannice, M. "Sulfur poisoning of supported palladium methanol synthesis catalysts." *Applied Catalysis B: Environmental*. 31 (1987): 133-157.
- Brinkmann, T., Sartorius, D., and Frimmel, F. "Photobleaching of humic rich dissolved organic matter." *Aquatic Science* 65 (2003): 415-424.
- Chaplin, B., Roundy, E., Guy, K., Shapley, J., and Werth, C. "Effects of natural water ions and humic acid on catalytic nitrate reduction kinetics using an alumina supported Pd-Cu catalyst." *Environmental Science and Technology*. 40 (2004): 3075-3081.
- Cone, M. Thesis: *Effects of solvent composition and hydrogen pressure on the catalytic conversion of 1,2,4,5-tetrachlorobenzene to cyclohexane*. University of South Florida. Ann Arbor: ProQuest, 2013.
- Doong, R., and Lai, Y. "Dechlorination of tetrachloroethylene by palladized iron in the presence of humic acid." *Water Research*. 39 (2005): 2309-2318.
- Frimmel, F. "Impact of light on the properties of aquatic natural organic matter." *Environment International* 24 (1998): 559-571.
- Gross, M., Pisarello, M., Pierpauli, K., and Querini, C. "Catalytic deoxygenation of water: Preparation, deactivation, and regeneration of palladium on a resin catalyst." *Industrial & Engineering Chemistry Research*. 49 (2010): 81-88.

- Heck, K., Nutt, M., Alvarez, P., and Wong, M. "Deactivation resistance of Pd/Au nanoparticle catalysts for water-phase hydrodechlorination." *Journal of Catalysis* 267 (2009): 97-104.
- Kamiya, M. and Kameyama, K. "Effects of selected metal ions on photodegradation of organophosphorous pesticides sensitized by humic acids." *Chemosphere* 44 (2001): 231-235.
- Kopinke, F.-D., Andeles-Wedler, D., Fritsch, D., and Mackenzie, K. "Pd-catalyzed hydrodechlorination of chlorinated aromatics in contaminated waters-effects of surfactants, organic matter and catalyst protection by silicone coating." *Applied Catalysis B: Environmental* 96 (2010): 323-328.
- Kung, H. "Deactivation of methanol synthesis catalysts- A review." *Catalysis Today*. 11 (1992): 443-453.
- Liao, C., Lu, M., and Su, S. "Role of cupric ions in the H₂O₂/UV oxidation of humic acids." *Chemosphere* 44 (2001):913-919.
- Lowry, G.V., and Reinhard, M. "Pd-catalyzed TCE dechlorination in groundwater: Solute effects, biological controls, and oxidative catalyst regeneration." *Environmental Science & Technology* 34 (2000): 3217-3223.
- Moran, M., and Zepp, R. "Role of photoreactions in the formation of biologically labile dissolved organic matter." *Oceanography* 42 (1997): 1307-1316.
- Moulijn, J., van Diepen, A., Kapteijn, F. "Catalyst deactivation: is it predictable? What to do?" *Applied Catalysis A: General* 212 (2001): 3-16.
- Münster, U., Salonen, K., and Tulonen, T. "Decomposition –Photochemical degradation of dissolved organic carbon and its ecological significance." *Backhuys Publishers* (1999):225-264.
- Navon, R., Eldad, S., Mackenzie, K., and Kopinke, F. "Protection of palladium catalysts for hydrodechlorination of chlorinated organic compounds in wastewaters." *Applied Catalysis B: Environmental*. 119-120 (2012): 241-247.
- Osborn, C. Thesis: *Catalytic hydrodehalogenation and hydrogenation of halogenated aromatic organic contaminants for application to soil remediation*. University of South Florida. Ann Arbor: ProQuest, 2011.

- Schüth, C., Disser, S., Schüth, F., and Reinhard, M. "Tailoring catalysts for hydrodechlorination chlorinated hydrocarbon contaminants in groundwater." *Applied Catalysis B: Environmental*. 28 (2000): 147-152.
- Simone, D., Kennelly, T., Brungard, N., and Farrauto, R. "Reversible poisoning of palladium catalysts for methane oxidation." *Applied Catalysis*. 70 (1991): 87-100.
- Speitel, G. and Clossman, F. "Chlorinated solvent biodegradation by methanotrophs in unsaturated soils." *Journal of Environmental Engineering* 117 (1991): 541-548.
- Stanmore, B. R. "The formation of dioxins in combustion systems." *Combustion and Flame*. 136 (2004): 398-427.
- Ticknor, J. Thesis: *Analysis and remediation of chlorinated hydrocarbons in environmental media*. University of South Florida. Ann Arbor: ProQuest, 2012.
- Tratnyek, P., Scherer, M., Deng, B., and Hu, S. "Effects of natural organic matter, anthropogenic surfactants, and model quinones on the reduction of contaminants by zero-valent iron." *Water Research*. 35 (2001) 4435-4443.
- Tuppurainen, K., Halonen, I., Ruokojarvi, P., Tarhanen, J., and Ruuskanen, J. "Formation of PCDDs and PCDFs in municipal waste incineration and its inhibition mechanisms: a review." *Chemosphere*. 36 (1998): 1493-1511.
- US EPA, 2001. A Citizen's Guide to Solvent Extraction. Publication EPA-542-F-01-0009.
- Wall, A., Stratton, G. "Comparison of methods for the extraction of pentachlorophenol from aqueous and soil systems." *Chemosphere* 22 (1991): 99-106.
- Wee, H. Dissertation: *Remedial extraction and catalytic hydrodehalogenation for treatment of soils contaminated by halogenated hydrophobic organic compounds*. Texas A&M University. Ann Arbor: ProQuest, 2007.
- Wee, H., Cunningham, J. "Palladium-catalyzed hydrodehalogenation of 1,2,4,5-tetrachlorobenzene in water-ethanol mixtures." *Journal of Hazardous Materials* 155 (2008): 1-9.
- Wee, H., Cunningham, J. "Remediation of contaminated soil by solvent extraction and catalytic hydrodehalogenation: Semi-continuous process with solvent recycle." *Environmental Progress and Sustainable Energy*. 30 (2011): 589-598.

Wee, H., Cunningham, J. “Soil treatment by solvent extraction and catalytic hydrodehalogenation.” *International Journal of Environment and Waste Management*. 11 (2013): 59-74.

Zhang, T., Lu, J., Ma, J., and Qiang, Z. “Fluorescence spectroscopic characterization of DOM fractions isolated from a filtered river water after ozonation and catalytic ozonation.” *Chemosphere*. 71 (2008): 911-921.