

5-20-2004

## The Developing Nucleus Accumbens Septi: Susceptibility to Alcohol's Effects

Rex Montgomery Philpot  
*University of South Florida*

Follow this and additional works at: <https://digitalcommons.usf.edu/etd>



Part of the [American Studies Commons](#)

---

### Scholar Commons Citation

Philpot, Rex Montgomery, "The Developing Nucleus Accumbens Septi: Susceptibility to Alcohol's Effects" (2004). *USF Tampa Graduate Theses and Dissertations*.  
<https://digitalcommons.usf.edu/etd/1196>

This Dissertation is brought to you for free and open access by the USF Graduate Theses and Dissertations at Digital Commons @ University of South Florida. It has been accepted for inclusion in USF Tampa Graduate Theses and Dissertations by an authorized administrator of Digital Commons @ University of South Florida. For more information, please contact [digitalcommons@usf.edu](mailto:digitalcommons@usf.edu).

The Developing Nucleus Accumbens Septi: Susceptibility to Alcohol's Effects

by

Rex Montgomery Philpot

A dissertation submitted in partial fulfillment  
of the requirements for the degree of  
Doctor of Philosophy  
Department of Psychology  
College of Arts and Sciences  
University of South Florida

Major Professor: Cheryl L. Kirstein, Ph.D.  
Mark Goldman, Ph.D.  
Toru Shimizu, Ph.D.  
James Willott, Ph.D.  
Lynn Wecker, Ph.D.

Date of Approval:  
May 20, 2004

Keywords: Addiction, Adolescence, Alcohol, Dopamine, Nucleus Accumbens

© Copyright 2004, Rex Philpot

Your spirit was my inspiration.  
More than friend and wife.  
Through the years I labored, lost -  
in truth, you were my life.

I would like to thank all of the faculty and staff involved in my education at the University of South Florida. Your knowledge and support have made this rocky road far, far smoother. In particular I would like to thank James Jenkins, for his endless nuggets of wisdom, many of which I took to heart much more than my behavior would suggest; Douglas Nelson, who's example as a professor I aspire to emulate; and Lynn Wecker, who gave me a good shove when I really needed it most. I would also like to thank Florencia Stanley, who has been here since I started and has always had the answers to my problem du jour. Thank you all.

I would like to thank all the members of the Kirstien lab, past and present, who have shared the load through the years. There are too many to name here. I would not have completed this project were it not for all of your efforts.

I would like to thank Cheryl Kirstien for her guidance. You have been many things to me and you have helped me grow in more ways than as an academic. Many years ago I knocked on your door, a lost undergraduate looking for an opportunity to prove my worth. You gave me so much more than just an opportunity that day, you gave me a future.

I would like to thank my Mother and Father, for bringing me into this world and providing me with the means, and the tools, to achieve this goal. Knowing you would always be there if I needed you has given me more strength than you will ever know. And to my Brother and Sister, you have both been an inspiration to me, although as the youngest I try hard to hide my admiration, both of you cleared the path that I have been traveling.

To my children, Rebecca and Grace, I am so grateful that I was given this time with you. Your joy for life has brought a smile to my face and warmed my heart at the end of many an otherwise horrid day. I love you both very much.

To Elizabeth, thank you for being my friend and companion through it all. There are no words for what you mean to me, or what you meant when I needed you most. You will always be near to my heart.

## TABLE OF CONTENTS

LIST OF FIGURES	iv
LIST OF TABLES	v
LIST OF DIAGRAMS	vi
ABSTRACT	vii
INTRODUCTION	1
The Problem of Adolescent Substance Use	1
Sensation Seeking and Substance Use	3
Conditioned Place Preference and Drug-Induced Motivation	4
Neurochemistry, Reward and Drugs of Abuse	5
Adolescence, NP, CPP and Neurochemistry	7
Summary	9
ADOLESCENT TRANSITIONS IN NOVELTY PREFERENCE	11
Abstract	11
Introduction	13
Experiment One	18
Methods	18
Subjects	18
Apparatus	18
Training	19
Behavioral Testing	19
Analysis	20
Results	20
Baseline Analysis	20
Novelty Preference	23
Discussion	23
Experiment Two	24
Methods	24
Subjects	24
Apparatus	24
Training	25

Behavioral Testing	25
Analysis	25
Results	26
Baseline Analysis	26
Novelty Preference	27
Discussion	27
General Discussion	28
References	32
PLACE CONDITIONING: AGE-RELATED CHANGES IN THE REWARDING AND AVERSIVE EFFECTS OF ALCOHOL	35
Abstract	35
Introduction	37
Methods	43
Subjects	43
Apparatus	43
Ages	44
Training	44
Testing	44
Design and Analyses	45
Results	46
Discussion	48
References	53
EFFECTS OF REPEATED ETHANOL ON BASAL DOPAMINE LEVELS	59
Abstract	59
Introduction	61
Methods	62
Results and Discussion	64
References	66
ETHANOL MEDIATED DOPAMINE RELEASE IN THE NUCLEUS ACCUMBENS SEPTI OF ADOLESCENT ANIMALS	67
Abstract	67
Introduction	68
Methods	72
Animals	72
Surgery	72
Dialysate Analysis	73
Ethanol-Induced NAcc DA Release Across Age	73
Results	74
Basal Levels	74

DOPAC	74
DA	76
DOPAC/DA	76
Treatment Effects	80
DOPAC	80
DA	81
DOPAC/DA	81
Temporal Effects	81
DA	81
Saline	81
Acute (Figures Seven A-D)	83
0.2 g/kg EtOH	83
0.5 g/kg EtOH	83
1.0 g/kg EtOH	84
2.0 g/kg EtOH	86
Repeated (Figures Eight A-D)	86
0.2 g/kg EtOH	86
0.5 g/kg EtOH	87
1.0 g/kg EtOH	87
2.0 g/kg EtOH	88
Expectancy (Figures Nine A-D)	90
0.2 g/kg EtOH	90
0.5 g/kg EtOH	90
1.0 g/kg EtOH	91
2.0 g/kg EtOH	91
Discussion	93
References	99
 GENERAL DISCUSSION	 104
Conclusions	107
 LITERATURE CITED	 110
 APPENDICES	 126
Appendix A: Stereotaxic Localization of the Developing Nucleus Accumbens Septi	127
Appendix B: The Attentional Model of the Nucleus Accumbens Septi and Addiction	143
 ABOUT THE AUTHOR	 End Page

## LIST OF FIGURES

ADOLESCENT TRANSITIONS IN NOVELTY PREFERENCE	
Figure One: Novelty Preference Across Age 4 Familiarization Trials	22
Figure Two: Novelty Preference Across Age 8 Familiarization Trials	26
PLACE CONDITIONING: AGE-RELATED CHANGES IN THE REWARDING AND AVERSIVE EFFECTS OF ALCOHOL	
Figure One: Activity Levels Across Age	46
Figure Two: Alcohol Place Conditioning	48
EFFECTS OF REPEATED ETHANOL ON BASAL DOPAMINE LEVELS	
Figure One: Basal DA in Dialysate (nM) Across Age	64
Figure Two: Basal DOPAC/DA Ratio Across Age	65
ETHANOL MEDIATED DOPAMINE RELEASE IN THE NUCLEUS ACCUMBENS SEPTI OF ADOLESCENT ANIMALS	
Figure One: Basal DOPAC Levels in the NAcc	75
Figure Two: Basal DA Levels in the NAcc	77
Figure Three: Basal DOPAC/DA Levels in the NAcc	78
Figure Four: DOPAC Peak Area Under the Curve Following Ethanol Administration	79
Figure Five: DOPAC Area Under the Curve Following Ethanol Age X Treatment	80
Figure Six: DA Area Under the Curve Following Ethanol Treatment	82
Figure Seven: Effects of Acute EtOH	85
Figure Eight: Effects of Repeated EtOH	89
Figure Nine: Effects of Expected EtOH	92
APPENDICES: Appendix A	
Figure One: Interaction of Gender and Age on Weight	137
Figure Two: Anterior Coordinates by Weight	138
Figure Three: Lateral Coordinates by Weight	139
Figure Four: Ventral Coordinates by Weight	140



## LIST OF TABLES

ADOLESCENT TRANSITIONS IN NOVELTY PREFERENCE	
Table One: Figurines	19
APPENDICES: Appendix A	
Table One: Optimal Coordinates be Mean Weight	137

## LIST OF DIAGRAMS

APPENDICES: Appendix B	
Diagram One	153
Diagram Two	154
Diagram Three	155
Diagram Four	157
Diagram Five	158

## The Developing Nucleus Accumbens Septi: Susceptibility to Alcohol Effects

Rex Montgomery Philpot

### ABSTRACT

The mesolimbic dopamine (DA) system has been implicated in providing the basis of pleasure, guiding the general mechanism of reinforcement as well as motivation. Support for these roles have grown from neurochemical research in the field of addiction. It is now well known that DA activity increases in the nucleus accumbens septi (NAcc) with exposure to addictive substances. Moreover, pharmacological manipulation of this system produces predictable changes in the administration of drugs of abuse, as well as natural reinforcers. This system is responsive to natural reinforcers and addiction may be the transference of routine mesolimbic function to environmental stimuli predictive of drug administration. The role of the NAcc in addiction specifically appears to be the facilitation of attention to drug-paired stimuli and addiction may be the behavioral manifestation of conditioned NAcc DA reactivity to the presence of drug-related stimuli. Although these findings have been reported in adults, few studies have focused on adolescence, the time when drug use/abuse begins. Adolescents may be particularly susceptible to addiction when considered in the light of this hypothesis. Recent research has revealed that the mesolimbic system of periadolescent animals is undergoing dramatic transition in functional tone. DA receptor and transporter levels are up regulated, synthesis rates are altered, and innervation from prefrontal cortex (PFC),

involved in regulating tonic and phasic DA activity, is increasing. Consequently, during adolescence there is a dramatic change in tonic DA levels, variations in phasic responses to acute drug administration and alterations in how the system adapts to repeated drug exposure. The present study utilizes the procedures of conditioned place preference, Novelty preference and in vivo microdialysis to determine how this conditioning process changes during the period of adolescence. The results indicate that adolescents are different from adults not only on behavioral measures associated with drug abuse, but in their neurochemical responsiveness to alcohol, and that these differences are related to a general developmental aspect of adolescence that renders them susceptible to addiction.

## INTRODUCTION

### **The Problem of Adolescent Substance Use**

The initiation of drug use increases dramatically during adolescence. By twelfth grade, approximately 80.3% of U.S. adolescents have used alcohol at some time, an increase from 51.7% for 8<sup>th</sup> graders (SAMHSA 2003a). Adult lifetime prevalence data indicate 81.3% have had experience with alcohol, a rate only slightly higher than in adolescence, suggesting that during adolescence most individuals have their first experience with the drug. Importantly, the rate of initiation of alcohol use among those 18 and younger nearly doubled from 1990 to 2000 (SAMHSA 2003b) revealing a decade long rise in the initiation of use in the adolescent population. Recent statistics reveal that 17.3% of 12-17 year olds are currently using alcohol, an increase from 16.4% in 2000, and the rate of current use increases tremendously during this time (SAMHSA 2003b). A reported 2.6% of 12 year olds have used alcohol within the past month. However, by 17 years of age this rate has increased to nearly 35.0% (SAMHSA 2003a). Additionally, 10.6% and 2.5% of those in this age range are binge users or heavy drinkers respectively, and the rate of substance abuse or dependence is 8.9%, and an estimated 1.5 million at this age in need of treatment for an alcohol problem (SAMHSA 2003b). These data indicate both a significant initiation of use in early adolescence, a rapid increase in use and a significant risk of addiction during the adolescent period.

Many reports have indicated a disturbing relationship between age of drug use initiation and subsequent rates of substance related problems (Kandel 1982; Kandel and Logan 1984; Robins and Przybeck 1985; Kandel and Davies 1992; Breslau et al. 1993; Anthony and Petronis 1995; DeWit et al. 2000). The lifetime prevalence of drug dependence problems is significantly higher in those initiating drug use prior to the age of 15, than in those initiating use after this time (Robins and Przybeck 1985). In 2002 17.9% of adults whose first experience with alcohol was prior to 15 years of age were classified with abuse of, or dependence on, alcohol as adults; This is in contrast to 3.7% of adults whose first alcohol experience was after the age of 18 (SAMHSA 2003b). These results do not appear related to differences in the total duration of use. Anthony and Petronis (Anthony and Petronis 1995) report that the highest probability of developing drug related problems within one year of initiation is among 15 year olds (19.01%) and is lowest for those 18 or older (9.36%). Additionally, the probability of developing problems within seven years of initial use decreases as a function of age, 68.07% for those 12 years or younger compared to 26.71% for those 18 or older. These statistics can be interpreted as those predisposed to addiction tend to initiate drug use earlier in life, however an alternate interpretation is available. There is some evidence to suggest that personality characteristics associated with substance abuse and addiction (risk taking, impulsivity, novelty seeking) exhibit a developmental trajectory that peaks in adolescence and that this association ‘may be propelled by the physiological changes of puberty’ (Martin et al. 2002). This suggests that a biological transition produces behavioral patterns that increase the probability of initial substance use and that this use

may interfere with the normal developmental trajectory, increasing the probability of substance abuse or dependence.

### **Sensation Seeking and Substance Use**

The personality trait of sensation seeking has a well-established association with drug use initiation, regular drug use and addiction vulnerability (Kilpatrick et al. 1976; Zuckerman 1979; Zuckerman and Neeb 1979; Zuckerman 1983; Pedersen 1991; Bates et al. 1994; Zuckerman 1994; Franques et al. 2000). This trait is characterized by the “seeking of varied, novel, complex, and intense sensations and experiences, and the willingness to take physical, social, legal, financial risks for the sake of such experiences” (Zuckerman 1994). Recent reports suggest that sensation seeking can be shaped by experiences (Bardo et al. 1996), and more importantly, that it exhibits a developmental trajectory, with demonstrable elevations in adolescence (Zuckerman 1994). As previously mentioned, several reports indicate an increased risk of substance abuse or addiction contingent upon the age of use initiation (Kandel and Logan 1984; Anthony and Petronis 1995; DeWit et al. 2000). Recent studies have demonstrated a relationship between developmental increases in sensation seeking and current and long term drug use in the adolescent population (Martin et al. 2002; Crawford et al. 2003).

Research in rodents has attempted to establish the relationship between sensation seeking, drug addiction and developmental neurobiology. Using novelty preference as a measure, researchers have determined that novel stimuli activate the same brain regions [the mesolimbic dopamine (DA) system] that mediate the rewarding effects of addictive compounds (Bardo et al. 1996). Attraction to novelty is a quantifiable component of sensation seeking that is useful in drawing parallels between the human condition and

animal models of substance abuse. The preference for novelty has been successfully utilized as an indicator of sensation seeking in humans (Gunnarsdottir et al. 2000) while research in rodents reveals a strong relationship between novelty preference and sensitivity to psychomotor stimulants. Rats with higher novelty-preferences: 1) demonstrate greater sensitivity to the locomotor effects of amphetamine; 2) are more easily conditioned with amphetamine in a conditioned place preference (CPP) paradigm (discussed below) and 3) are more sensitive to and more accurately discriminate amphetamine doses (Bevins et al. 1997; Klebaur and Bardo 1999) supporting the contention that the novelty preference paradigm, like sensation seeking in humans, is a reliable indicator of addiction vulnerability.

### **Conditioned Place Preference and Drug-Induced Motivation**

The CPP procedure allows for the measurement of the motivational capacity of an associated stimulus. In this paradigm subjects are not reinforced for a behavior, but rather receive multiple pairings between a neutral context and an unconditioned stimulus. The tendency to approach or avoid the stimulus paired context when give free access is presumed to represent the appetative or aversive capacity of the unconditioned stimulus. Therefore, in the case of drug-induced conditioning, the demonstration of a CPP or conditioned place aversion (CPA) represents the motivational capacity of the examined drug (Bardo and Bevins 2000).

In adults, associative conditioning procedures induce demonstrable place preferences using natural rewards such as food (Papp 1988; Guyon et al. 1993; Perks and Clifton 1997) or sexual stimuli (Miller and Baum 1987; Hughes et al. 1990; Mehrara and Baum 1990). Further, a CPP is routinely reported using psychomotor stimulants (cocaine



or amphetamine) as the Unconditioned Stimulus (US) (for review see (Tzschentke 1998). However, in rats there have only been limited reports of ethanol producing a CPP and the effectiveness has been dependent upon pre-exposure (Reid et al. 1985; Gauvin and Holloway 1992; Holloway et al. 1992; Bienkowski et al. 1995), extensive pairings (Bozarth 1990) or the use of selectively bred ethanol preferring lines (Colombo et al. 1990). Induction of an ethanol CPP has been more successful in mice {for discussion see (Cunningham et al. 1993)}. However, regardless of species, without additional manipulation ethanol typically induces a CPA (Stewart and Grupp 1986, 1989; Gauvin and Holloway 1992; Holloway et al. 1992; Schechter and Krimmer 1992) or has no effect (Asin et al. 1985) on place preference.

### **Neurochemistry, Reward and Drugs of Abuse**

A common feature of all drugs that induce a CPP is the ability to alter neurochemical activity in the midbrain and limbic system (White 1996; Koob and Nestler 1997; Leshner and Koob 1999). In the mid-1950's researchers James Olds and Peter Milner discovered that electrical stimulation of the medial forebrain bundle (MFB) produced a CPP, suggesting that activation of these projection fibers was rewarding (Olds and Milner 1954). This discovery implicated the neurotransmitter systems that comprise the MFB (dopamine, norepinephrine, serotonin) as central to the reward process (Fouriez et al. 1978; Speciale et al. 1978; Wise 1978; Olds and Fobes 1981). The use of histofluorescence techniques has revealed a strong correspondence between brain-stimulation reward sites and dopamine (DA) systems that pass through the MFB (Dahlstrom and Fuxe 1964; Fuxe 1965; Arbuthnott et al. 1970; Wise 1981) suggesting that DA systems are the critical components for the reward mediating capacity of the

MFB. Substantial evidence supports the notion that DAergic systems mediate the motivational component of hedonic behaviors such as drinking, eating and sexual activity (Heffner et al. 1977; Wise et al. 1978; Zigmond et al. 1980; Xenakis and Sclafani 1981; Geary and Smith 1985; Hoebel 1985; Schneider et al. 1986; Blackburn et al. 1987; Smith and Schneider 1988; Weatherford et al. 1990; Tyrka and Smith 1993; Hsiao and Chen 1995; Hsiao and Smith 1995). Additionally, systemic or central administration of DA agonists can produce a CPP and DA agonists and antagonists can alter operant behaviors in a fashion indicative of altered reinforcement (Yokel and Wise 1975; Phillips and Fibiger 1978; Gallistel and Karras 1984; Koob and Hubner 1988). These data suggest a central role of DA in the administration of abusable drugs, specifically that animals can monitor drug-induced states and alterations in drug efficacy related to DA systems, modifying behavioral output to compensate for neurochemical changes.

One DA system implicated in these motivated behaviors is the mesocorticolimbic pathway, originating in the ventral tegmental area (VTA) and projecting to the limbic system (e.g. nucleus accumbens septi (NAcc), amygdala, hippocampus, septum, olfactory bulb, bed nucleus of the stria terminalis) and prefrontal cortex (Le Moal and Simon 1991). The mesolimbic structure most frequently implicated in mediating these DAergic processes is the NAcc, which receives DAergic input from the VTA and constitutes one of the projection areas of the MFB. Manipulations that directly stimulate the DA receptors in the NAcc reinforce many behaviors (Olds and Fobes 1981). Electrical stimulation of the NAcc itself, or any of the pathways which result in increased DA efflux within the NAcc, produces behavioral reinforcement and animals will lever press for this stimulation (Arbuthnott et al. 1970; Crow 1971; Anlezark et al. 1972; Crow

1972a, 1972b; Anlezark et al. 1973; Crow 1973; Anlezark et al. 1974; Anlezark et al. 1975; Ranaldi and Beninger 1994). Additionally, injections of DA agonists into the NAcc have rewarding effects producing a CPP (Hoebel et al. 1983). This region also appears to be directly involved in the reinforcing effects of cocaine (Moghaddam and Bunney 1989) and the administration of numerous drugs, including alcohol, all elicit a significant increase in DA levels in the NAcc (Phillips et al. 1983; Koob 1992a, 1992b; Koob et al. 1994; Koob 1996; Phillips and Shen 1996; Koob 1999, 2000). These data implicate dopaminergic (DAergic) activity, specifically in the NAcc, as critical in the process of drug-induced reinforcement and possible addiction and implicates DA and the NAcc as key areas for investigation regarding the unique profiles observed in adolescent drug use.

#### **Adolescence, NP, CPP and Neurochemistry**

Adolescence in the rodent has been defined using various factors indicative of developmental transition in human adolescents. These factors include changes in behavioral patterns, in hormonal patterns, and/or in primary sexual characteristics. In a comprehensive review (Spear 2000) argues that adolescence cannot be defined based solely on the characteristics we associate with puberty and sexual maturation, but that adolescence is a period of 'soft events' that should be viewed as a period of transitions that cannot be clearly delineated. Using the appearance of growth spurt, pruning of excitatory synapses as well as unique behavioral transitions in the rat (increased peer interaction and play; exploratory behavior in the wild) Spear defines adolescence broadly from postnatal day (PND) 28 to PND 42, with the acknowledgement that in males some traits may appear as late as PND 55 (Spear 2000). Other reviewers report similar broad classifications defined by the appearance of mature hormonal cycling (PND 28-30) and

the subsequent appearance of reproductive maturity (as late as PND 60 in males) (Smith 2003). Within this broad range some researchers have identified the categories of early- (PND 21-34), mid- (PND 34-46) and late- (PND 46-59) adolescence centered around the appearance of puberty (between PND 33-44) and bracketed by weaning (PND 21) and reproductive maturity (PND 59) (Tirelli et al. 2003).

Using this temporal frame to study adolescence, there appears to be parallel developmental trajectories in the NP of rodents and sensation seeking in human adolescents. Adolescent mice demonstrate greater novelty preference (Adriani et al. 1998), and human adolescents exhibit elevated sensation seeking scores (Zuckerman 1994), than adult counterparts. The presence of these developmental patterns in laboratory animals suggest a biologically driven developmental trajectory underlying sensation seeking that is indicative of increased risk of drug use and subsequent addiction in the adolescent population. A recent report by Martin et al (Martin et al. 2002) supports the adolescent transition and biological basis of sensation seeking in humans. Programmed changes in the central nervous system structures involved in reward and reinforcement may underlie this developmental pattern in NP, however the use of CPP to measure transitions in reward in the adolescent has been a neglected area. Amphetamine and cocaine have been shown to induce a CPP in animals as young as 3 weeks of age and into adolescence (Laviola et al. 1992; Cirulli and Laviola 2000; Tirelli et al. 2003; Schramm-Sapota et al. 2004). Additionally, nicotine has been demonstrated to induce a CPP in adolescent animals (Vastola et al. 2002) or alleviate an aversion . These studies substantiate the effectiveness of the paradigm in evaluating drug conditioning in the

developing animal. However, prior to this project no published studies have demonstrated ethanol-mediated place conditioning in the adolescent animal.

Research has examined the developmental patterns of DA (Anderson et al. 1997), DA receptors (Hedner and Lundborg 1985; Andersen and Gazzara 1994; Andersen and Teicher 2000; Andersen et al. 2002) and transporters (Coulter et al. 1996, 1997) through adolescence. Neurochemically, basal DA synthesis in the NAcc are lower in PND 30 than PND 40 rats and turnover rates for PND30 animals is less than reported in adults (Anderson et al. 1997). Research on DA receptor populations indicates a pattern of overproduction and pruning that occurs across adolescence in a sex-specific manner (Teicher et al. 1995; Andersen et al. 1997). This pattern is true in humans as well (Seeman et al. 1987). The density of D1, D2, and D4 receptors in the NAcc increases to a peak at PND 28, then declines significantly to adult levels at PND 60 (Tarazi and Baldessarini 2000). Furthermore, D3 receptor numbers appear to increase monotonically, with some reports finding adult levels at weaning (Demotes-Mainard et al. 1996) but others finding D3 levels in weanlings far lower than adults (Stanwood et al. 1997). In conjunction with receptor density changes, D1 stimulatory and D2 inhibitory effects on adenylyl cyclase production are less apparent in adolescence than adults (Andersen and Teicher 2000). Parallel to these changes, DA transporter levels are undergoing developmental changes, increasing in concentration in the NAcc to adult levels through adolescence (Coulter et al. 1996, 1997).

### **Summary**

The data are clear that the adolescent is unique with respect to drug use tendencies and vulnerability to addiction. The characteristic of sensation seeking has long been

reported as an indicator of increased risk for addiction and there is a developmental transition in this trait, peaking in adolescence. This suggests the possibility of a developmental transition in the rewarding or reinforcing efficacy of drugs of abuse that peaks in adolescence. The use of CPP procedures in adolescent animals has provided some evidence, albeit limited, that adolescents find abused substances more rewarding. This may be due to the adolescent development of the mesolimbic DA system, the NAcc and brain regions that modulate its activity. Significant evidence indicates that the NAcc is a central player in the reward response to drugs of abuse and a growing body of literature indicates that these regions are neurochemically distinct in the adolescent. Spear (2000) has suggested that this neurochemical transition represents a developmental trajectory within which the adolescent animal begins to explore its potential and develop independence. It is suggested here that because drugs of abuse act through this developing system, that exposure to alcohol during this time can alter the programmed pattern of development, rendering the individual at increased risk to develop subsequent alcohol related problems. The present study utilized the methods of NP, CPP and microdialysis to evaluate adolescent transitions in sensation seeking, ethanol reward and ethanol-induced effects, acute, repeated and expected, on reward related behavior and neurochemistry.

## ADOLESCENT TRANSITIONS IN NOVELTY PREFERENCE

### **Abstract**

Recent research has revealed a strong relationship between a rodent's preference for novelty and sensitivity to psychomotor stimulants. Animals with exhibiting a high response to novelty are more easily conditioned with amphetamine in a conditioned place preference (CPP) paradigm, and are more sensitive to and more accurately discriminate amphetamine doses. In humans, novelty preference (NP) is used as an indicator of sensation seeking which is strongly correlated with addiction vulnerability. Evidence suggests that preference for novelty and drug-taking behaviors are mediated by the mesolimbic dopamine (DA) system, specifically the nucleus accumbens septi (NAcc). During adolescence there are substantial developmental changes in the mesolimbic system, with significant over production and pruning of DA receptors, changes in DA synthesis, increases in DA transporter levels, and differential activation of DA-regulated second messenger systems. The behavioral measure of NP appears to be an indicator of drug sensitivity. Thus, the present study used a playground maze procedure to measure changes in NP across age. The present findings demonstrate a significant preference for novel stimuli in developing animals. Preadolescent, postnatal day 24 (PND 24) animals exhibited a significant preference for novelty that was not present in early adolescent (PND 34), or early adult animals (PND 59). Late adolescent (PND 44) animals exhibited a significant aversion to novel stimuli. An increase in habituation trials resulted in a

similar pattern of reduced NP into adolescence, however the increased exposures attenuated the late adolescent aversion and resulted in a preference for novelty in adult animals. The data indicate strong behavioral differences in NP between early adolescence and adulthood that may be related to a developmental increase in contextual regulation of behavior.



## **Introduction**

Drug use begins early in development. For example, approximately 80.3% of U.S. adolescents have used alcohol by 12<sup>th</sup> grade, an increase from 51.7% for 8<sup>th</sup> graders (SAMHSA 2003a). Adult lifetime prevalence data indicate 81.3% have had experience with alcohol, a rate only slightly higher than in adolescence, suggesting that during adolescence most individuals have their first experience with the drug. Importantly, the rate of initiation of alcohol use among the 12-17 age group increased from 111.0/1,000 potential new users to 158.8/1,000 from 1991 to 1996 (Johnston et al. 2002) revealing a recent rise in the initiation of use in the adolescent population. The numbers for use and initiation are similar for illicit substances. For example, 8.6% of 12<sup>th</sup> graders have used cocaine, an increase from 4.5% for 8<sup>th</sup> graders (Johnston et al. 2002). These data in adolescents compare to a lifetime prevalence of 10.6% in adults (SAMHSA 2003b) suggesting that most users initially experience cocaine well before adulthood. The age-specific rate of new use of cocaine for ages 12-17 has climbed steadily from 1.2 in 1992 to 5.6 in 1997 (SAMHSA 2003b) again indicating a trend toward adolescent initiation in drug use. The National Household Survey (SAMHSA 2003b) for the age group 18-25 indicates that 48.1% have experienced some illicit drug in their lifetime. Further, the Monitoring the Future Study (Johnston et al. 2002), a detailed study of youth trends, indicates that by 12<sup>th</sup> grade 54.1% have used some form of illicit drug. Additionally, among youths ages 12-13, 2.9% were current illicit drug users with the highest rates found among young people ages 16-17 (16.4%), and ages 18-20 (19.9%) (Johnston et al. 2002). These data indicate not only a significant initiation of use in early adolescence but also a rapid increase in use during the adolescent period. Together, these data

demonstrate the need for critical study into the dynamics of drug exposure and abuse potential among the adolescent population.

Arnett (Arnett 1999) has shown a relative tendency towards sensation seeking in adolescence, a factor that Zuckerman associates with increased likelihood of risk taking behaviors (Zuckerman 1986), including drug use or initiation. Measures of sensation seeking are highly correlated with approach to novelty or NP in humans (McCourt et al. 1993). Given these findings, preference for novelty appears to be a valid measure of risk taking behavior probability, specifically, drug use initiation. This assumption has been born out in the animal literature.

Numerous studies have demonstrated a strong correlation between behavioral reactivity to novel stimuli and both the reinforcing efficacy of psychomotor stimulants and self-administration rates in animals. Specifically, (Klebaur and Bardo 1999) have shown that novelty seeking behavior in rats is related to the reinforcing efficacy of psychomotor stimulants, with high responders for novelty displaying higher amphetamine-induced conditioned place preference (CPP). Additionally, self-administration probabilities for amphetamine are directly related to behavioral reactivity to a novel stimulus. In this study, animals that exhibited greater motor activity in the presence of novelty established self-administration patterns more readily (Piazza et al. 1990). These data suggest a strong relationship between sensation seeking, novelty seeking, drug self-administration and drug-related reinforcement, relationships which may be mediated by the functions of the mesolimbic dopamine (DA) system.

There is considerable evidence that the mesolimbic DA system is involved in the establishment and maintenance of a range of behaviors. Initial studies implicating the

nucleus accumbens septi (NAcc) date back to (Olds and Milner 1954), who discovered that electrical stimulation of the medial forebrain bundle could produce a CPP. Further research specifically implicated DA efflux in the NAcc as crucial to this process. Intracranial self-stimulation of the ventral tegmental area (VTA) supports lever-pressing behavior in rats, a behavior mediated by dopaminergic output in the NAcc (Mogenson et al. 1980). Specifically, injections of DA antagonists in the NAcc attenuates or blocks intracranial self-stimulation behavior. These data indicate that accumbal DA is critical in the maintenance of reinforced behavior and may be the underlying source of behavioral activation in novel situations.

Studies with drugs of abuse parallel these findings. Drugs of abuse have a common ability to induce dopaminergic activity in the mesocorticolimbic system (Koob 1992) a quality that, given the role of the NAcc in reinforcement, suggests a strong possibility for a role in addictive behavior. Specifically, rats will readily self-administer drugs of abuse directly into the NAcc and self-administration behavior can be altered by co-injecting a dopaminergic antagonist into the NAcc (Caine et al. 1995). Additionally, infusing amphetamine into the NAcc produces a CPP suggesting elevations of accumbal DA are reinforcing (McBride et al. 1999).

It is important to note that novel stimuli have been shown to elevate DA in the NAcc. Rebec et.al. (Rebec et al. 1997) have reported enhanced DA efflux in the NAcc during exposure to a novel environment. Specifically, in a familiar environment, animals exhibited lower levels of NAcc DA efflux in comparison to dopaminergic activity in a novel environment. Additionally, lesioning the NAcc attenuated locomotor activity in response to a novel stimulus, indicating a relationship between the NAcc and behavioral

reactivity to novelty (Bardo et al. 1996). Injections of 6-OHDA into the NAcc reduced both mesolimbic DA and subsequent NP. This suggests that dopaminergic activity of the mesolimbic system mediates the behavioral aspects of NP in rats. Further, microdialysis studies have shown a direct correlation between reaction to novelty and amount of "drug-stimulated DA release in the NAcc" (Bradberry et al. 1991). Moreover, high locomotor responsivity to a novel environment has been correlated with enhanced amphetamine-induced dopaminergic activity in the NAcc (Hooks and Kalivas 1995). Therefore, it appears there is a strong relationship between the behavioral reactivity to novelty and the neurochemical effects of drugs and it appears that these processes share a common neural substrate.

It is clear that adolescence is a period of tremendous experimentation and risk taking (Spear 2000) a pattern that, in the arena of drug abuse, manifests itself as first time drug use and potentially drug abuse (Zuckerman 1974). It is likely that neurophysiological changes in the mesolimbic system during development may mediate the initiation of drug use and potentiate the likelihood of abuse during adolescence. Specifically, it is clear that in both human and rodent populations the mesolimbic DA systems are undergoing tremendous transition. For example, basal DA synthesis in the NAcc is lower in postnatal day 30 (PND 30) than PND 40 rats and turnover rates for PND 30 animals are less than those reported in adults (Andersen et al. 1997).

Receptor populations also are in flux during development, with a pattern of overproduction and pruning that occurs across adolescence in a sex-specific manner (Teicher et al. 1995; Andersen et al. 1997; Andersen and Teicher 2000). Males exhibit greater levels across age and greater over production of D1 and D2 receptor types than

females. This pattern is similar in humans as well (Seeman et al. 1987). In rats, the density of D1, D2, and D4 receptors in the NAcc increase and reach peak levels at PND 28, and then decline significantly to adult levels at PND 60 (Tarazi and Baldessarini 2000). Additionally, D3 receptor numbers appear to increase monotonically, with some reports finding adult levels at weaning (i.e., PND 21) (Demotes-Mainard et al. 1996) but others finding D3 levels in weanlings far lower than those observed in adults (Stanwood et al. 1997). In conjunction with receptor density changes, D1 stimulatory and D2 inhibitory effects on adenylyl cyclase production are less apparent in adolescence than in adults (Andersen and Teicher 1999). DA transporter levels are also undergoing substantial change, increasing in concentration in the NAcc to adult levels through adolescence (Coulter et al. 1996, 1997). This dynamic transition during adolescence suggests that processes that are mediated by the mesolimbic DA system are unlikely to manifest themselves similarly in adults and adolescents. Moreover, across adolescence there may be tremendous transitions in reactivity to stimuli (e.g., novel stimuli or drugs) that act on these systems.

As previously mentioned, novelty and novel stimuli produce profiles in the NAcc that are similar to those caused by drugs of abuse. Additionally, behavioral measures of novelty responsiveness has a strong relationship with behavioral measures of drug conditionability and underlying neurochemical responsivity to drugs of abuse. Therefore, a preference for novelty across adolescence can be viewed as an indicator of the potential for abuse and addiction liability if use is initiated during this time. In the present studies, preferences for novelty were measured across the periadolescent period using the

playground maze paradigm developed by Nicholls et al. (Klebaur and Bardo 1999) to determine potential differences in developing adolescent animals.

## **Experiment One**

### *Methods*

#### *Subjects*

Forty Three Sprague-Dawley (Zivic Miller Laboratories) rat pups weighing 60-300g at the time of testing were used as subjects in these experiments. No more than one male and one female per litter were used in a given condition (pups were derived from 10 separate litters). Pups were sexed and culled to 10 pups per litter on postnatal day 1 (PND 1). Pups remained housed with their respective dams in a temperature and humidity-controlled vivarium on a 12:12h light: dark cycle (07:00 h/19:00 h) until PND 21, pups were weaned and individually housed.

#### *Apparatus*

The NP apparatus and procedure were adapted from Nicholls et al. (Nicholls et al. 1992). Animals were tested on a white plastic circular platform (216 cm in diameter) standing 70 cm from the ground. Eight black circles (28 cm in diameter) were evenly spaced outlining the perimeter of the tabletop. Each black circle was situated 30 cm away from the edge of the tabletop and 55 cm from the center. Eight different plastic figurines were adhered to the middle of each black circle with Velcro (see Table 1 for a list of the 10 figurines). The figurine's average size ranged from about 5x2x2 cm to 2x2x7 cm. A video camera was hung directly over the table to record the animal's behavior for later scoring (see analysis).

Table One: Figurines

Figurine Number	Figurine Identity
1	Baseball Player
2	Race Car
3	Coral
4	Whistle
5	Yellow Bird
6	Bottle
7	Chair
8	Salt Shaker
9	Dolphin
10	Scuba Diver

**Table One** : Listing of object number and corresponding characteristics

#### *Training*

Rats were handled on either PND 21, 31, 41 or 56 for one three-minute session to minimize stress levels due to handling. For the next three consecutive days (PND 22-24, 32-34, 42-44 and 57-59) each rat was placed on the playground maze facing away from the experimenter and allowed to freely explore the novel environment for three minutes. The experimenter left the room during the three-minute session. The table and figurines were wiped down with alcohol between each session to control for olfactory cues. Each day, the eight figurines were randomly distributed among the black circles.

#### *Behavioral Testing*

On the fourth consecutive day, rats were exposed to a familiarization trial. Animals were placed in the familiar apparatus for 3 min, removed for 1 min while a novel object was placed instead of a random familiar object. Rats were again placed on

the table facing away from both the experimenter and their novel object for three minutes to freely explore the familiar environment. The novel object was randomized for each litter; however, one male and one female per litter received the same object as novel.

### *Analysis*

A video recorder hanging above the table taped behavior during training and testing sessions. The length of time each rat spent investigating each figurine was recorded (i.e., when the animal's head was within the black circle). Number of entries and duration of entries were recorded. Four separate 2 (Sex) x 4 (Age) x 4 (Familiarization day) x 8 (Zone or Object) analyses were performed to determine any baseline differences in time or entries in a given zone and time or entries for a given object. Analysis of NP used a 2 (Sex) x 4 (Age) x 8 (Zone) ANOVA with preference score (adjusted percent time in novel zone minus mean adjusted percent time in familiar zones) as the dependent variable. Fisher Protected LSD tests were used to isolate significant effects.

### *Results*

#### *Baseline Analysis*

Analyzing for baseline preference revealed significant main effects of Age,  $F(3, 126) = 16.921, p < 0.05$ , and Zone (time per zone)  $F(7, 882) = 5.901, p < 0.05$ . Subsequent post hoc analyses of Age using Fisher's PLSD revealed significant differences in mean zone time between ages PND 25 ( $x = 9.835$ ), 35 ( $x = 6.539$ ), 45 ( $x = 6.468$ ) and 60 ( $x = 3.529$ ), between PND 35 and 60, and between PND 45 and 60. Subsequent planned comparisons of Zone indicated there were significant differences in baseline preference between locations, with zones 1, 2 and 8 being preferred over other zones. Although not statistically significant, there was a trend for an Age X Zone



interaction,  $F(21, 882) = 1.555$ ,  $p = 0.0532$ , with young animals exhibiting larger zone preferences than adults.

Analyzing for the number of entries into each zone revealed significant main effects for Age,  $F(3, 126) = 16.722$ ,  $p < 0.05$  and Zone,  $F(7, 882) = 11.367$ ,  $p < 0.05$ . Subsequent post hoc analyses of Age using Fisher's Protected LSD indicated significant differences in zone entries between ages PND 25 ( $x = 3.800$ ) and 60 ( $x = 2.381$ ), between PND 35 ( $x = 4.119$ ) and 45 ( $x = 3.289$ ) or 60, and between PND 45 and PND 60. Subsequent planned comparisons of Zone indicated there were significant differences in the number of entries per zone, with zones 1, 2 and 8 being entered more frequently. There was also a significant Zone X Age interaction,  $F(21, 882) = 1.635$ ,  $p < 0.05$ , with adult animals generally exhibiting fewer entries than younger animals with little preference for any specific zone.

Analysis of time spent at each object revealed significant main effects of Age,  $F(3, 126) = 15.783$ ,  $p < 0.05$  and Object,  $F(9, 1134) = 7.781$ ,  $p < 0.05$ . Subsequent post hoc analyses of Age using Fisher's PLSD indicated significant differences in mean time per object between ages PND 25 ( $x = 9.278$ ) 35 ( $x = 6.382$ ), 45 ( $x = 6.521$ ) or 60 ( $x = 4.340$ ), between PND 35 and 60, and between PND 45 and 60. Subsequent planned comparisons of Object indicated there were significant differences between objects, with objects 5, 6 and 7 being preferred over other objects.

Analysis of the number of entries for each object revealed significant main effects of Age,  $F(3, 126) = 16.189$ ,  $p < 0.05$  and Object,  $F(9, 1134) = 8.40$ ,  $p < 0.05$ . Subsequent post hoc analyses of Age indicated significant differences in object entries between ages PND 25 ( $x = 3.769$ ) and 60 ( $x = 2.663$ ), between PND 35 ( $x = 4.020$ ) and

45 ( $x = 3.403$ ) or 60, and between PND 45 and 60. Subsequent planned comparisons of Object indicated there were significant differences between objects, with objects 5, 6 and 7 having more entries than other objects. There was also a significant Object X Age interaction,  $F(27, 1134) = 1.963$ ,  $p < 0.05$ , with animals at every age showing different object preferences. There was also a significant Object X Age X Familiarization Day interaction,  $F(81, 1134) = 1.613$ ,  $p < 0.05$ , with animals at every age showing different object preferences on the four different familiarization days.

**Figure One Novelty Preference Across Age  
4 Familiarization Trials**

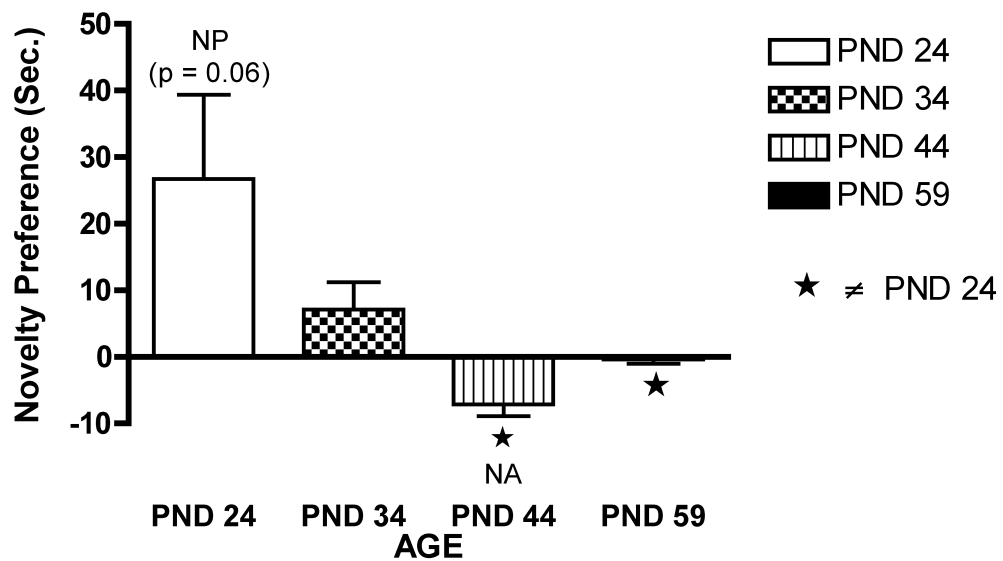

**Figure One** : Developmental differences in novelty preference as a function of age with 4 habituation trials. Adjusted preference score represents the total time spent with the novel object/zone minus the mean time spent with the familiar objects/zones with a correction for age related basal differences in zone preference. Preadolescent animals (PND 24) exhibit a significant preference for novelty, while late adolescent (PND 44) animals exhibit a significant aversion. Additionally, late adolescent and adult animals (PND 44, 59) are significantly different from preadolescent animals.

### *Novelty Preference*

Baseline object preference across familiarization days was mediated by zone preferences across age. Therefore, only 'novel object zone preference' was used for analysis of NP to allow for baseline correction. To eliminate any zone bias due to baseline preferences, scores for each zone were adjusted by the baseline zone preference for that age. This adjusted score was used to compute NP. The mean adjusted time spent in the familiar object zones was subtracted from the adjusted time spent in the novel object zone to generate the preference score. Using this formula there was a significant main effect for Age,  $F(3, 39) = 6.165, p < 0.05$ . Subsequent post hoc analyses of age using Fisher's PLSD revealed significant differences between ages PND 24 ( $x = 26.74$ ) and 44 ( $x = -7.123$ ) or PND 59 ( $x = -0.3624$ ). Analysis for preference or aversion revealed a trend toward NP ( $p = 0.0674$ ) in PND 24 animals and a significant novelty aversion [ $t(13) = 4.050, p < 0.05$ ] in PND 44 animals (See Figure One).

### Discussion

Postnatal day 24 animals demonstrated greater exploration of objects than any other age, while adolescent animals (i.e., PND 34,44) explored the objects more than the adults did. All animals entered more often and spent more time in zones 1, 2 and 8. These zones were near objects in the room that were in close visual proximity to the playground maze. NP scores were calculated by correcting for this baseline preference. In the original study by Nicholls et al. (Nicholls et al. 1992) no zone preferences were observed, however that study used adult animals only. It is interesting to note that this effect was less pronounced in adult animals in the present study. Both preadolescent (i.e., PND 25) and adolescent (i.e., PND 35, 45) animals entered zones more frequently than

adult animals on training days. Examining the responses to objects on training days showed that 25 day-olds explored more objects than all other ages while adolescent animals explored more than adult animals did.

To verify and extend the results of this study a visual barrier was employed to eliminate the influence of extra-apparatus visual stimuli on behavior. Additionally, consideration was given to the influence of rate of habituation on the outcome of Experiment One. Given the short temporal parameters of this study it is possible that the results were affected by an age related deficit in acquisition rates. In short, animals that were not familiarized with 4 exposures would not react to a new stimulus in the same fashion as animals that have completely habituated. This result, however, would not constitute a lack of NP. Therefore, to reduce stress during the first exposure to the playground maze, the number of handling sessions prior to familiarization was increased to 6 sessions over 3 days. Additionally, the number of daily exposures to the apparatus was doubled, increasing the total number of familiarization trials to 8 prior to testing. The reduction of stress on trial one due to increased handling and the increased number of trials should allow sufficient time to fully habituate to the objects.

## **Experiment Two**

### *Methods*

#### *Subjects*

Eighty two Sprague-Dawley (Zivic Miller Laboratories) rat pups weighing 60-300g at the time of testing were used as subjects in these experiments. Animal care and environmental conditions were identical to those in Experiment One.

#### *Apparatus*

The NP apparatus was modified from Experiment One to include a white vinyl curtain that encircled the NP platform to prevent any potential influence of external

visual stimuli on the distribution of behavior within the open field. All other conditions were identical to Experiment One.

#### *Training*

To test the hypothesis that reduced preference for novelty in adolescence was due to a lack of habituation the number of object familiarization trials was doubled. Rats were handled beginning on either PND 18, 28, 38 or 53 for three-minute sessions, twice a day (9:00 hr and 15:00 hr) for three consecutive days, to minimize stress levels due to handling. Over the next four days (PND 21-24, 31-34, 41-44 and 56-59) each rat was placed in the playground maze, twice per day (9:00 hr and 15:00 hr), facing away from the experimenter and allowed to freely explore the novel environment for three minutes. The table and figurines were wiped down with alcohol between each session to control for olfactory cues. Each day, the eight figurines were randomly distributed among the black circles. The experimenter left the room during the three-minute session.

#### *Behavioral Testing*

On the afternoon of the fourth day, rats were exposed to a familiarization trial. Animals were placed in the familiar apparatus for 3 min, removed for 1 min while a novel object replaced a random familiar object. Rats were again placed on the table facing away from both the experimenter and their novel object for three minutes to freely explore the familiar environment. The novel object was randomized for each litter; however, one male and one female per litter received the same object as novel.

#### *Analysis*

All data were quantified using a behavioral tracking system (Noldus Ethovision) coupled to a digital video camera suspended above the playground maze. The length of time each rat spent investigating each figurine was recorded (i.e., when the animal's head

was within the black circle). Four separate 2 (Sex) x 4 (Age) x \* (Familiarization trial) x 8 (Zone or Object) analyses were performed to determine any baseline differences in time in a given zone and with a given object. Analysis of NP used a 4 (Age) x 8 (Zone) ANOVA of preference score (adjusted percent time in novel zone minus mean adjusted percent time in familiar zones). Fisher Protected LSD tests were used to isolate significant effects.

### Results

#### *Baseline Analysis*

No differences in basal zone or object preference were observed using the enclosed playground maze.

**Figure Two Novelty Preference Across Age  
8 Familiarization Trials**

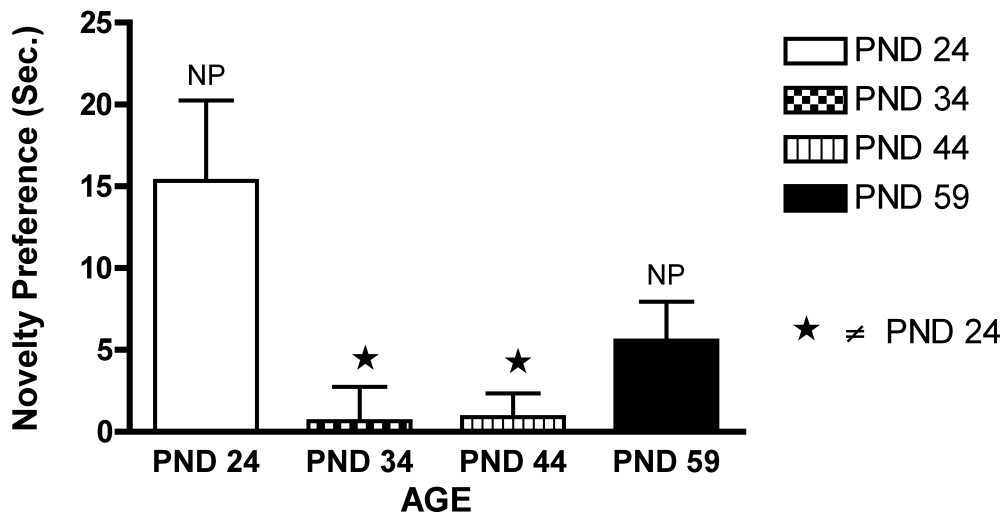

**Figure Two:** Developmental differences in novelty preference as a function of age with 8 habituation trials. Adjusted preference score represents the total time spent with the novel object/zone minus the mean time spent with the familiar objects/zones. Preadolescent (PND 24) and early adult (PND 59) animals exhibit a significant preference for novelty, while early and late adolescent and animals (PND 34, 44) demonstrate no response to novelty.

### *Novelty Preference*

There was a significant main effect for Age,  $F(3, 71) = 3.976, p < 0.05$ . Subsequent post hoc analyses of age using Fisher's PLSD revealed significant differences between ages PND 24 ( $x = 15.33$ ) and PND 35 ( $x = 0.639$ ) or PND 45 ( $x = 0.887$ ). Analysis for NP revealed a significant preference in PND 24 [ $t(21) = 2.233, p < 0.05$ ] and 59 animals [ $t(21) = 2.344, p < 0.05$ ] (See Figure Two).

### Discussion

The addition of a visual barrier successfully eliminated basal zone preferences within the playground maze. The findings are consistent with the results from Experiment One, indicating a reduction in NP in adolescence compared to preadolescent counterparts. It was hypothesized that the absence of significant NP in adolescents and adults in Experiment One resulted from limited habituation trials and that with more thorough familiarization a clear response to novelty would be manifest. However, the overall pattern varied with increased habituation. Preadolescent (PND 24) and early adolescent (PND 34) animals demonstrated a reduction, while late adolescent (PND 44) and early adult (PND 59) animals demonstrated an increase, in novelty preference scores with increased habituation. Although Experiment Two was designed to examine the influence of habituation on the demonstration of NP, the results are suggestive of an elevation in experimental anxiety through adolescence and into adulthood. The presence of additional handling sessions as well as increased experience with the experimental context affected preadolescent animals minimally. Although PND 24 animals did not demonstrate a statistically significant NP with 4 habituation trials, the absolute preference score was larger than 8 trial counterparts and did not differ statistically. NP in PND 34 animals also

did not differ with increased habituation trials, however, increasing the number of trials did result in a difference between PND 24 and PND 34 animals with early adolescent demonstrating significantly lower scores. Interestingly, the addition of habituation trials served to shift scores toward a preference in late adolescent and early adult animals, alleviating an aversion in the former and inducing a preference in the latter. NP has traditionally been considered as a behavioral correlate to sensation seeking in the human population and a fundamental component of this trait is risk taking or reduced perceived risk. These results suggest a developmental increase in perceived risk that hinders the demonstration of NP with age and this can be attenuated with experience.

### **General Discussion**

The present results demonstrate an age-specific transition in the effectiveness of novel stimuli to attract and sustain exploratory behaviors. Early after weaning, preadolescent pups have a significant preference for new stimuli, and this response to novelty changes in early adolescence. By late adolescence and on to early adulthood there is a dramatic drop in NP with relatively few familiarization trials. In fact, late adolescent animals exhibit a novelty-induced aversion (i.e., neophobia) relative to familiar stimuli. These patterns suggest that there is a greater likelihood of exploration and experimentation with unfamiliar objects, environments and conditions in early adolescence as compared to late adolescence or adulthood.

From a developmental perspective, a shift from NP to aversion has been explained as the typical functional adolescent transition during development. Facilitation of active exploring of the environment in the physically capable being increases environmental skills and abilities that are necessary for and/or increase the probability of



competitive success and survival (Spear 2000). However, once sufficient time has passed, and presumably sufficient learning has occurred, it is detrimental to enter new situations rather than remain in more comfortable domains, given that in the experienced animal such situations are more likely to present higher survival risk than contribute to competitive benefit.

Such behavioral changes are likely mediated by developmental transitions in a number of brain structures known to mediate motivational and behavioral processes. Of specific interest to this research are the NAcc, and the prefrontal cortex (PFC). These structures have been repeatedly demonstrated to mediate the initiation and maintenance of a range of behaviors. Further, substantial evidence is emerging that these structures are anatomically and functionally dissimilar in adolescents and adults, and that the transition process of these structures appears to occur during the adolescent period. For example, the PFC declines in volume during adolescence (Jernigan et al. 1991), exhibits reduced glutamatergic input (Virgili et al. 1990) and increased DA input (Rosenberg and Lewis 1994, 1995; Lewis et al. 1998). Further, as mentioned previously there are substantial changes occurring in these dopaminergic systems as well (Andersen and Gazzara 1996; Coulter et al. 1996; Andersen et al. 1997; Stanwood et al. 1997).

The observed shift in NP for during adolescence may be directly related to the developmental transitions reported in these structures. There appears to be a transition in the regulatory role of the PFC through adolescence, with early periadolescent behavior being predominantly impulsive, or affectively regulated, while later adolescent behavior appears to be more contextually regulated (Spear 2000). This behavioral transition may result from a shift in the ability of the PFC or amygdala to modulate activity in the NAcc.

Spear has suggested that elevated DA in the PFC in the preadolescent may result in disinhibition of amygdalar inputs to the NAcc while simultaneously inhibiting medial PFC input to the NAcc. The net result of such a shift in functional regulation of NAcc activity is reduced contextual and increased emotional regulation of NAcc activity given that the amygdala appears to be involved in the processing of emotionally salient events. However, as the neurochemical projections to the PFC and PFC interconnections with the NAcc develop during adolescence there is increased regulation of attention and behavior to contextually important, rather than affectively-salient stimuli [for discussion see Spear (2000)].

The relationship between behaviors like novelty seeking and drug use (Klebaur and Bardo 1999) may be mediated by these developing structures and developmental changes in novelty seeking may not only indicate the likelihood of drug use but reflect ongoing changes in the functional interconnections of the mesocorticolimbic system. Sustained drug use during this transitional period may result in a greater probability of addiction later in life by effectively altering the course of development of these circuits, sustaining a more affectively regulated motivational system. Therefore, these data suggest a transitional period in neural development in which the initiation of drug use is both more likely and potentially more costly. Such outcomes are born out in the human literature given that addiction is twice as likely if use starts before the age of 15, than if initiation occurs after 18 years of age. Further, these data indicate that the likelihood of addiction is not mediated by the length of use, but rather by when use was initiated (Anthony and Petronis 1995). Interestingly, the estimated probability of future addiction exhibits its steepest ascent across 15-18 years of age, regardless of initial age of initiation,

suggesting some critical component to the combination of drug use and age during this developmental period.

The present data provide a measure of evidence for a distinct biological transition in NP during adolescence. Prior evidence has shown that sensation seeking and novelty seeking are predictors of substance abuse liability in humans (Zuckerman 1986; McCourt et al. 1993). This predictive relationship has also been demonstrated in adult rodents (Klebaur and Bardo 1999). Moreover, novelty seeking and substance abuse share some underlying neural substrates (Bradberry et al. 1991; Bardo et al. 1996). Given these findings, it seems likely that changes in novelty preference resulting from ongoing developmental processes can provide a simple behavioral measure for increased risk of addiction as a function of age. Using procedures such as this to study development and the processes involved in adolescence and drug abuse is a critical area of research.

## References

- Andersen, S. L. and R. A. Gazzara (1996). Effects of (-)-sulpiride on dopamine release in striatum of developing rats: Degree of depolarization influences responsiveness. *J Neurochem* **67**(5): 1931-7.
- Andersen, S. L., M. Rutstein, J. M. Benzo, J. C. Hostetter and M. H. Teicher (1997). Sex differences in dopamine receptor overproduction and elimination. *Neuroreport* **8**(6): 1495-8.
- Andersen, S. L. and M. H. Teicher (1999). Cyclic adenosine monophosphate (camp) changes dramatically across periadolescence and region. *Society for Neuroscience Abstracts* **25**: 1471.
- Andersen, S. L. and M. H. Teicher (2000). Sex differences in dopamine receptors and their relevance to adhd. *Neurosci Biobehav Rev* **24**(1): 137-41.
- Anthony, J. C. and K. R. Petronis (1995). Early-onset drug use and risk of later drug problems. *Drug Alcohol Depend* **40**(1): 9-15.
- Arnett, J. J. (1999). Adolescent storm and stress, reconsidered. *Am Psychol* **54**(5): 317-26.
- Bardo, M. T., R. L. Donohew and N. G. Harrington (1996). Psychobiology of novelty seeking and drug seeking behavior. *Behav Brain Res* **77**(1-2): 23-43.
- Bradberry, C. W., R. J. Gruen, C. W. Berridge and R. H. Roth (1991). Individual differences in behavioral measures: Correlations with nucleus accumbens dopamine measured by microdialysis. *Pharmacol Biochem Behav* **39**(4): 877-82.
- Caine, S. B., S. C. Heinrichs, V. L. Coffin and G. F. Koob (1995). Effects of the dopamine d-1 antagonist sch 23390 microinjected into the accumbens, amygdala or striatum on cocaine self-administration in the rat. *Brain Res* **692**(1-2): 47-56.
- Coulter, C. L., H. K. Happe and L. C. Murrin (1996). Postnatal development of the dopamine transporter: A quantitative autoradiographic study [published erratum appears in *brain res dev brain res* 1996 jan 2;98(1):150]. *Brain Res Dev Brain Res* **92**(2): 172-81.
- Coulter, C. L., H. K. Happe and L. C. Murrin (1997). Dopamine transporter development in postnatal rat striatum: An autoradiographic study with [3h]win 35,428. *Brain Res Dev Brain Res* **104**(1-2): 55-62.
- Demotes-Mainard, J., C. Henry, Y. Jeantet, J. Arsaut and E. Arnould (1996). Postnatal ontogeny of dopamine d3 receptors in the mouse brain: Autoradiographic evidence for a transient cortical expression. *Brain Res Dev Brain Res* **94**(2): 166-74.
- Hooks, M. S. and P. W. Kalivas (1995). The role of mesoaccumbens--pallidal circuitry in novelty-induced behavioral activation. *Neuroscience* **64**(3): 587-97.
- Jernigan, T. L., J. R. Hesselink, E. Sowell and P. A. Tallal (1991). Cerebral structure on magnetic resonance imaging in language- and learning-impaired children. *Arch Neurol* **48**(5): 539-45.

- Johnston, L. D., P. M. O'Malley and J. G. Bachman (2002). Monitoring the future national results on adolescent drug use: Overview of key findings, 2001. Bethesda, MD, National Institute on Drug Abuse: NIH Publication No. 02-5105.
- Klebaour, J. E. and M. T. Bardo (1999). Individual differences in novelty seeking on the playground maze predict amphetamine conditioned place preference. *Pharmacol Biochem Behav* **63**(1): 131-6.
- Koob, G. F. (1992). Drugs of abuse: Anatomy, pharmacology and function of reward pathways. *Trends Pharmacol Sci* **13**(5): 177-84.
- Lewis, D. A., S. R. Sesack, A. I. Levey and D. R. Rosenberg (1998). Dopamine axons in primate prefrontal cortex: Specificity of distribution, synaptic targets, and development. *Adv Pharmacol* **42**: 703-6.
- McBride, W. J., J. M. Murphy and S. Ikemoto (1999). Localization of brain reinforcement mechanisms: Intracranial self- administration and intracranial place-conditioning studies. *Behav Brain Res* **101**(2): 129-52.
- McCourt, W. F., R. J. Gurrera and H. S. Cutter (1993). Sensation seeking and novelty seeking. Are they the same? *J Nerv Ment Dis* **181**(5): 309-12.
- Mogenson, G. J., D. L. Jones and C. Y. Yim (1980). From motivation to action: Functional interface between the limbic system and the motor system. *Prog Neurobiol* **14**(2-3): 69-97.
- Nicholls, B., A. Springham and J. Mellanby (1992). The playground maze: A new method for measuring directed exploration in the rat. *J Neurosci Methods* **43**(2-3): 171-80.
- Olds, J. and P. Milner (1954). Positive reinforcement produced by electrical stimulation of septal area and other regions of rat brain. *J Comp Physiol Psychol* **47**(6): 419-27.
- Piazza, P. V., J. M. Deminiere, M. le Moal and H. Simon (1990). Stress- and pharmacologically-induced behavioral sensitization increases vulnerability to acquisition of amphetamine self- administration. *Brain Res* **514**(1): 22-6.
- Rebec, G. V., J. R. Christensen, C. Guerra and M. T. Bardo (1997). Regional and temporal differences in real-time dopamine efflux in the nucleus accumbens during free-choice novelty. *Brain Res* **776**(1-2): 61-7.
- Rosenberg, D. R. and D. A. Lewis (1994). Changes in the dopaminergic innervation of monkey prefrontal cortex during late postnatal development: A tyrosine hydroxylase immunohistochemical study. *Biol Psychiatry* **36**(4): 272-7.
- Rosenberg, D. R. and D. A. Lewis (1995). Postnatal maturation of the dopaminergic innervation of monkey prefrontal and motor cortices: A tyrosine hydroxylase immunohistochemical analysis. *J Comp Neurol* **358**(3): 383-400.
- SAMHSA (2003a). Alcohol use by persons under the legal drinking age of 21, Substance Abuse and Mental Health Services Administration.

- SAMHSA (2003b). Results from the 2002 national survey on drug use and health: National findings. Rockville, Substance Abuse and Mental Health Services Administration.
- Seeman, P., N. H. Bzowej, H. C. Guan, C. Bergeron, L. E. Becker, G. P. Reynolds, E. D. Bird, P. Riederer, K. Jellinger, S. Watanabe and et al. (1987). Human brain dopamine receptors in children and aging adults. *Synapse* **1**(5): 399-404.
- Spear, L. P. (2000). The adolescent brain and age-related behavioral manifestations. *Neurosci Biobehav Rev* **24**(4): 417-63.
- Stanwood, G. D., S. McElligot, L. Lu and P. McGonigle (1997). Ontogeny of dopamine d3 receptors in the nucleus accumbens of the rat. *Neurosci Lett* **223**(1): 13-6.
- Tarazi, F. I. and R. J. Baldessarini (2000). Comparative postnatal development of dopamine d(1), d(2) and d(4) receptors in rat forebrain. *Int J Dev Neurosci* **18**(1): 29-37.
- Teicher, M. H., S. L. Andersen and J. C. Hostetter, Jr. (1995). Evidence for dopamine receptor pruning between adolescence and adulthood in striatum but not nucleus accumbens. *Brain Res Dev Brain Res* **89**(2): 167-72.
- Virgili, M., O. Barnabei and A. Contestabile (1990). Regional maturation of neurotransmitter-related and glial markers during postnatal development in the rat. *Int J Dev Neurosci* **8**(2): 159-66.
- Zuckerman, M. (1974). The sensation seeking motive. *Prog Exp Pers Res* **7**: 79-148.
- Zuckerman, M. (1986). Sensation seeking and the endogenous deficit theory of drug abuse. *NIDA Res Monogr* **74**: 59-70.

## **PLACE CONDITIONING: AGE-RELATED CHANGES IN THE REWARDING AND AVERSIVE EFFECTS OF ALCOHOL**

### **Abstract**

Alcohol abuse levels are very high in adolescents creating a significant societal issue. It has been shown that people who begin alcohol use as adolescents are more likely to become addicts than people who initiate alcohol use as adults. Importantly, the development of addiction in humans is more rapid with initiation in adolescence than in adulthood. In order to determine changes in the reinforcing efficacy of alcohol as a function of adolescent development we used a place conditioning paradigm. In this study we assessed the ability of ethanol to support a conditioned place preference (CPP) or aversion (CPA). Animals (postnatal days; PND 25, 35, 45 and 60) were tested for alcohol-induced conditioning in response to a range of ethanol doses (0.2, 0.5, 1.0, 2.0 g/kg/i.p. or saline). In general, there was a trend for alcohol to produce an aversion to the ethanol-paired compartment at higher doses. These patterns differed significantly as a function of age. Younger animals, PND 25 exhibited a CPP to a low dose and an aversion at high doses. Late adolescent (PND 45) animals exhibited a CPP at two moderate doses, but a CPA at the highest dose. PND 35 and 60 animals did not exhibit a CPP at any examined dose and PND 60 exhibited a progressive aversion with increasing dose. The data show that the developmental processes of adolescence influence general responsiveness to alcohol. Specifically, late adolescent animals (PND 45) appear to prefer doses of alcohol that are either not reinforcing (0.5) or aversive (1.0) at other ages.

These processes need to be examined thoroughly in order to understand the development of addiction in adolescence. This is especially important given that alcohol abuse in adolescence may interfere with the usual pattern of brain development as it relates to alcohol reinforcement.



## **Introduction**

Initiation of alcohol use in adolescence has unique consequences on the development of addiction in adulthood. For example, incidences of alcohol dependency are higher among those who initiate heavy drinking (5 drinks per occasion) before the age of 18 (Johnston et al., 2002). Individuals who begin drinking before the age of 15 are four times as likely to be alcohol-dependent adults than those who begin at 21. Importantly, total number of years of alcohol abuse does not impact the development of addiction as strongly as early alcohol use initiation (De Wit et al., 1999) indicating the important relationship between age of initiation and addiction. Generally, alcohol dependent adults initiate drinking at an earlier age and drink more frequently throughout adolescence than non-dependent counterparts (Guo et al., 2000). Younger age of initiation of alcohol use is highly associated with addiction severity as measured by the Addiction Severity Index (Tam et al., 2000) and age of alcohol initiation is inversely correlated with the magnitude of alcohol abuse in late adolescence (Hawkins et al., 1992, Grant and Dawson, 1998, DeWit et al., 2000). Importantly, adolescent initiation of alcohol use amplifies the effects social risk factors have on the development of addiction (e.g., parental drinking, proactive parenting, peer alcohol use, ethnicity)(Hawkins et al., 1997). Together these data suggest that alcohol use in adolescence has unique implications on the development of alcohol dependency.

A notable consideration often overlooked when examining the correlational links between adolescent use and addiction is the direction of effect. It is reasonable to assume that individuals prone to alcoholism are also those most likely to initiate drinking early in life, therefore producing a strong relationship between the two factors. However,

behavioral characteristics common to the addictive personality and the adolescent period (e.g., see below) give rise to the plausible hypothesis that adolescent alcohol use subsequently increases the risk of alcohol abuse and addiction. Most likely, there is a dynamic interaction between these and other factors that ultimately determine the risk of addiction. However, of importance here is the consideration of biological changes in the central nervous system (CNS) of the adolescent that may serve to motivate initial use and as a consequence, alter CNS development in a way that promotes prolonged use.

Clearly, psychological, biological and environmental factors all influence the development of addiction. Psychological factors, including specific personality traits (impulsiveness (Myers et al., 1995), sensation seeking, rebelliousness [(Zuckerman et al., 1984), impaired emotional well-being, low self-esteem (Kandel, 1980) and non-conformity to traditional morals and values (Kandel, 1980, Zuckerman et al., 1984)], Importantly, some of these traits are characteristic of adolescents in that they engage in risky behaviors more often than adults (Teichman et al., 1989). It may be that adolescents and addicts share specific biological commonalities that underlie the presence of similar personality and behavioral characteristics.

Special importance has been placed on sensation seeking behavior, a personality trait common to both alcohol dependents and adolescents (Zuckerman et al., 1984) (Teichman et al., 1989). Researchers have hypothesized that high sensation seekers enjoy the mind-altering experiences a drug offers whereas low sensation seekers are stressed by these experiences and therefore avoid them (Zuckerman et al., 1968). To examine this hypothesis, Klebaur and Bardo (1999) divided animals into high and low novelty preference groups and patterns of amphetamine conditioned place preference

(CPP) and self-administration were investigated (Klebaur et al., 2001). The results indicated that preference for novelty was directly related to the degree of conditionability with amphetamine (Klebaur and Bardo, 1999). Further, high novelty preference was directly related to amphetamine intake in a self-administration paradigm (Klebaur et al., 2001). Studies in adolescent mice have shown increased novelty/sensation seeking in adolescent animals in comparison to younger and older counterparts (Adriani et al., 1998). However, these studies have not been extended to make comparisons between these behaviors and drug effects. Adolescence is a period of increased social activity in general (Primus and Kellogg, 1989), and hyperactivity when exposed to a novel environment (Bronstein, 1972, Spear and Brake, 1983). Using the novelty seeking paradigm, relationships between ages, novelty preference and alcohol responses are currently being investigated in our laboratory.

The biological factor linking sensation/novelty seeking, adolescent development and alcohol addiction may be the developing mesolimbic DA system. The mesolimbic pathway, particularly the dopaminergic (DAergic) projection from the ventral tegmental area (VTA) to the nucleus accumbens septi (NAcc), has been implicated in behavioral reinforcement and is activated by alcohol administration (Johanson and Schuster, 1975, Stewart, 1984, Hernandez and Hoebel, 1988, Di Chiara and Imperato, 1988, Bergman et al., 1989, Hubner and Koob, 1990). Microdialysis studies have shown alcohol-induced increases in accumbal DA levels in alcohol-preferring rats (Katner and Weiss, 2001, Engleman et al., 2000). There is substantial evidence that this system mediates motivation in general, although the specific mechanism (e.g., attention, reward, motor, anticipation/expectancy) has been debated. Rats will self-administer DA re-uptake

inhibitors directly in the NAcc, suggesting the involvement of mesolimbic DA in the process of reinforcement (Kuhar et al., 1991). In addition, electrophysiological studies show heightened activation of DA neurons in the VTA during drug self-administration (Carelli et al., 2000) and activation patterns suggest an anticipatory or predictive role in that firing occurs before drug delivery once self-administration is established. Further, lesioning any part of the mesolimbic pathway alters drug taking behavior (Hubner and Koob, 1990) in a fashion indicative of loss of reinforcement. However, drug addiction relapse occurs along with, and can be induced by, reactivation of DA neurons (Stewart, 1984) suggestive of a motivational or predictive role. The neural mechanisms underlying alcohol addiction are more complex than many abused substances given that alcohol affects multiple interactive neurotransmitter systems in addition to DA (e.g., serotonin, GABA, opioid)(See (Koob, 1992). However, activation of the mesolimbic DA system is a common substrate of all addictive substances and therefore a point of focus in neurobiological research on alcohol addiction.

Although many studies have shown that changes in DA activity in the mesolimbic system affect the expression of substance use patterns in adult animals, relatively few have focused on adolescence, the time when drug use/abuse is typically initiated. In rodents adolescence is broadly defined as postnatal days (PND) 28 to 55 based on the onset of hormonal changes that initiate puberty (Ojeda and Urbanski, 1994, Odell, 1990). Behavioral changes that resemble those seen in human adolescence, such as increases in peer interaction, increased exploration, risk taking and play behavior appear from PND 28 to 42 (Spear, 2000). These changes provide a more precise developmental time frame that is congruent with both the physical and behavioral changes occurring in human

adolescents. Studies that have focused on responsiveness to drugs in adolescents have shown a decreased responsiveness to dopaminergic agonists (Bauer and Evey, 1981, Bolanos et al., 1998, Lanier and Isaacson, 1977, Spear and Brick, 1979, Infurna and Spear, 1979), and increased responsiveness to a DA antagonist (Spear et al., 1980). Recent studies examining the long term effects of alcohol during adolescence have found no baseline differences in their measures but significant changes in response to a subsequent ethanol challenge. Specifically, adult animals that were exposed to alcohol during adolescence have decreased EEG responsiveness with higher doses (Slawecki, 2002), decreased behavioral measures of intoxication during subsequent ethanol challenge (Slawecki, 2002, White et al., 2002), altered electrophysiology (Slawecki et al., 2001) and working memory impairments (White et al., 2000). Young adolescent animals also show a differential sensitivity to binge pattern alcohol-induced brain damage (Crews et al., 2000). These studies clearly demonstrate a unique susceptibility of the adolescent brain to alcohol's effects. Further studies are needed to examine how the mesolimbic DA pathway may be susceptible to alcohol-induced alterations during adolescence. Dynamic changes occur during this time period (Stanwood et al., 1997) including receptor overproduction and pruning (Andersen and Teicher, 2000; Tarazi and Baldessarini, 2000), specifically in the prefrontal cortex and limbic regions (for review see Spear, 2000). Overproduction and pruning occur in the dopaminergic, serotonergic, GABAergic and glutamatergic systems. Earlier studies reported D2 and D3 receptor densities to be similar in rats PND 21 and PND 60, but failed to include the adolescent period, a time of great change in the DA system (Stanwood et al., 1997). There is evidence for receptor population overproduction and pruning during adolescence (Andersen and Teicher, 2000,

Tarazi and Baldessarini, 2000). An important aspect for investigation in adolescence is the role drug-related environmental cues play in addiction. Such cues have been shown to induce alcohol conditioned drug-seeking behavior, craving and relapse (Weiss et al., 2001). Evidence suggests that repeated pairings of alcohol and specific environmental cues produce conditioned associations and expectancies in the drinker (Goldman, 2002) as well as physiological responses (Glautier, 2000). Animal models have also demonstrated conditioning to environmental cues associated with alcohol. Through classical conditioning, an animal associates not only the administration of a drug with its physiological effects, but also environmental cues that are repeatedly present during drug administration (York and Regan, 1982) and these cues may come to motivate future use.

The conditioned place preference (CPP) paradigm measures reward value of a drug utilizing drug-related environmental cues/context (Carr et al., 1989). The reinforcing effects of a drug are determined by the amount of time the animal spends in the drug-paired chamber in comparison to non-drug paired chamber. Mice spend more time in a chamber in which they received alcohol through jugular catheterization, suggesting a preference for the alcohol-paired chamber (Kelley et al., 1997). Moreover, animals selectively bred to exhibit stronger behavioral effects of alcohol show stronger conditioned place preferences (Cunningham et al., 1991, Risinger et al., 1994). In adult animals, CPP has been demonstrated with many drugs including cocaine (Spyraki et al., 1982a, Spyraki et al., 1982b) apomorphine (Wise et al., 1976) and morphine (Sherman et al., 1980). However, results have been variable in alcohol place conditioning in that some studies find a CPP (Stewart and Grupp, 1986, Stewart and Grupp, 1989, Gauvin and Holloway, 1992, Schechter, 1992, Morse et al., 2000, Cunningham and Henderson,

2000, Holloway et al., 1992, Ciccocioppo et al., 1999) and others find a conditioned place aversion (CPA) depending upon dose, (Cunningham and Henderson, 2000) strain (Schechter, 1992) and drug chamber timing interval (Stewart and Grupp, 1989) (Holloway et al., 1992, Ciccocioppo et al., 1999). The only studies that have examined place conditioning in adolescent animals have shown comparable place preferences between adolescents and adult animals with both cocaine and morphine (Campbell et al., 2000). Other studies investigating adolescents only demonstrate a CPP with cocaine but not morphine (Bolanos et al., 1996). To date, no one has investigated differences in alcohol-induced CPP across age. The present study investigated the relationship of age and alcohol-induced CPP in order to determine if adolescents are unique in their responsiveness to the rewarding efficacy of alcohol.

## **Methods**

### **Subjects**

Offspring (n=227, derived from 59 litters) of Sprague-Dawley breeding pairs (Zivic Miller Laboratories) weighing from 50 - 300 g (PND 25, 60-90g; PND 35, 120-160g; PND 45, 180-240; PND 60, 220-350g) at the time of testing were used in this study. No more than one male and one female per litter were used in a given condition. Pups were sexed and culled to 10 pups per litter on postnatal day one (PND 1). Pups remained housed with their respective dams in a temperature and humidity-controlled vivarium on a 12:12h light: dark cycle (07:00h/ 19:00h). On PND 21, pups were weaned and individually housed.

### **Apparatus**

The apparatus consisted of three visually and tactilely distinctive chambers: A large (21W x 36L x 21H, in cm.) 'neutral' chamber made of black Plexiglas and a floor

of black Plexiglas bisecting two end chambers (21W x 15L x 21H, in cm.) with distinct tactile and visual cues. End chambers contained either a checkerboard pattern on the walls with a wire mesh floor or a floral pattern on the walls with a rubberized floor. The chambers were separated by removable Plexiglas doors.

#### Ages

To determine the reinforcing efficacy of alcohol across adolescence, animals were divided into 4 age categories (PND 21-25, 31-35, 41-45, 56-60) and trained and tested according to the procedures outlined below.

#### Training

Animals were trained over a period of 4 days and tested 1 day following the final day of training in an unbiased CPP paradigm. Each morning animals were confined to either the 'Paired' or the 'Unpaired' compartment for 5 minutes following the administration of ethanol (0.2, 0.5, 1.0 or 2.0 g/kg i.p.) or saline. At each age half of the animals received saline and half received ethanol as their first exposure. Animals were placed in the alternate compartment in the afternoon and received a corresponding injection (eg., animals that received ethanol in the morning received saline in the afternoon and vice versa). The environment designated as the drug-paired environment was counterbalanced across all ages and conditions. An equal number of animals received ethanol in the checkers environment as did animals receiving ethanol in the floral environment. This procedure was repeated for a total of 4 training days (4 Paired, 4 Unpaired exposures).

#### Testing

On day 5 (i.e., PND 25, 35, 45 or 60), drug free animals were placed in the central portion of the neutral compartment and allowed free access to all three chambers for a



total of 5 minutes. Time spent in each chamber was recorded and preference was determined by comparing time spent in the 'Paired' compartment vs. 'Unpaired' compartment. Both absolute and relative comparisons were made. Relative comparisons divided drug paired chamber time by combined time in the drug paired and unpaired chambers.

#### Design and Analyses

Chamber entries were analyzed using a 3 factor mixed design ANOVA for Age (4; 25, 35,45 and 60) by Dose (5; Saline, 0.2, 0.5, 1.0 and 2.0 g/kg alcohol) with Chamber as a repeated measure. Preference scores were analyzed using a 2 factor ANOVA for Age (4; 25, 35,45 and 60) by Dose (5; Saline, 0.2, 0.5, 1.0 and 2.0 g/kg alcohol) with adjusted difference score as the dependent measure. Subsequent planned comparisons (Fischer PLSD; t-tests) were used to isolate effects

Preference scores were calculated as relative ratios to prevent any influence of the novel neutral chamber on the balanced conditioning across the paired and unpaired chambers. The relative ratio calculation serves to control for variations produced in paired and unpaired times as a result of time spent in the third, intermediate/novel chamber. The experimental question to be answered is whether animals prefer the drug paired chamber to the saline paired chamber. The animal's response to the introduction of a third chamber, the novel runway, should not influence these results. The relative ratio comparison allows for this direct comparison by removing neutral chamber scores and setting the total test time to the time in the two experimental chambers. However, because removing neutral scores will result in different total test times for each animal, the paired and unpaired scores must be converted to a percentage of total time to produce

an honest comparison uninfluenced by time spent in the novel neutral zone. It is important to note that such a conversion cannot make an aversion a preference or vice versa but merely removes the influence a novel third zone has on difference scores.

**Figure One: Activity Levels Across Age**

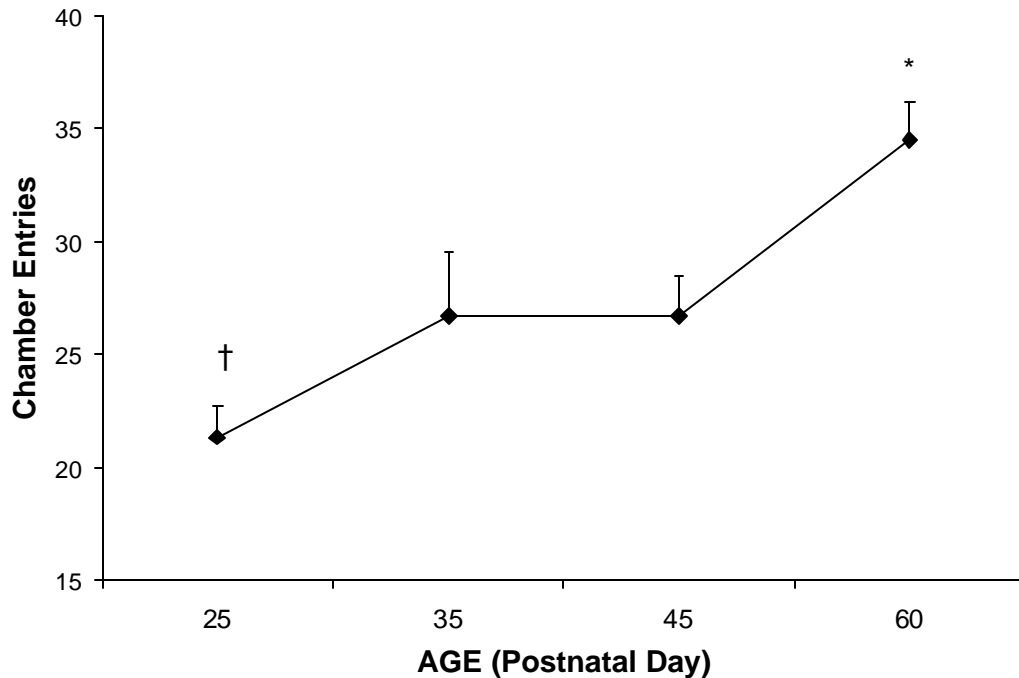

**Figure One:** Animals exhibited increased activity in the testing apparatus as a function of age. PND 25 animals exhibited fewer grid crossings than all other ages while PND 60 exhibited the most. † = Different from PND 35, 45 and 60 ( $p < 0.05$ ). \* = Different from PND 25, 35 and 45 ( $p < 0.05$ ).

## Results

Activity, measured by the total number of chamber entries, differed as a function of age ( $F(3, 110) = 14.24, p < 0.05$ ). There was no main effect of dose. Post-hoc Fishers LSD collapsing across dose indicated that PND 60 animals were more active than all other ages as demonstrated by total number of chamber entries (Figure 1). Preadolescent

animals (PND 25) made significantly less chamber entries than all other ages and adolescent animals (PND 35, 45) were intermediate in comparison to younger and older animals. Postnatal day 25 animals were significantly less active than PND 35 or 45 animals. Postnatal day 60 animals exhibited increased chamber entries (more activity) in comparison to all other ages. There were no baseline preferences or aversions (ie., side bias) for either chamber in saline controls at any age.

Preference scores for chamber were calculated as ratios of paired (P) and unpaired (UP) chamber times (% time in P-UP/total time in P and UP) to control for any age or dose differences in activity in the novel neutral chamber. As can be seen in Figure 2, there was a significant interaction of Age x Dose ( $F(12, 208) = 1.79, p=0.05$ ). The overall patterns were similar to those observed with raw difference scores (P – UP time), however, neutral chamber activity did appear to influence the raw scores somewhat. Using ratio scores PND 25 animals exhibited a preference at 0.2 g/kg and an aversion at 1.0 g/kg, with other doses not significantly affecting preference. Adolescent animals exhibited aversions at 0.2 g/kg (PND 45) and 1.0 g/kg (PND 35). A preference was observed in PND 45 animals at 0.5 and 1.0 g/kg. Adult animals exhibited a progressive reduction in preference score with increasing dose, with all doses producing a CPA, 0.2 g/kg the mildest, 0.5 and 1.0 intermediate and 2.0 producing the greatest aversion to the drug paired chamber. For clarity, only the relative to baseline comparisons are denoted in Figure 2, however, comparisons across age follow here. Again, adolescent animals were unique in their responsiveness to alcohol. PND 35 and PND 45 animals exhibited an aversion at 0.2 g/kg greater than PND 60 animals. However, PND 45 animals exhibited a preference at both the 0.5 and 1.0 g/kg doses, while the PND 35 animals showed only an

aversion at the 1.0 g/kg dose. Despite the strong preference observed at 1.0 g/kg for PND 45 animals, a strong aversion was seen for PND 45 animals at the 2.0 g/kg dose. Preference scores did not differ significantly among the saline-injected control groups at any age [see Figure 2; Saline (0 g/kg)]

**Figure Two: Alcohol Place Conditioning**

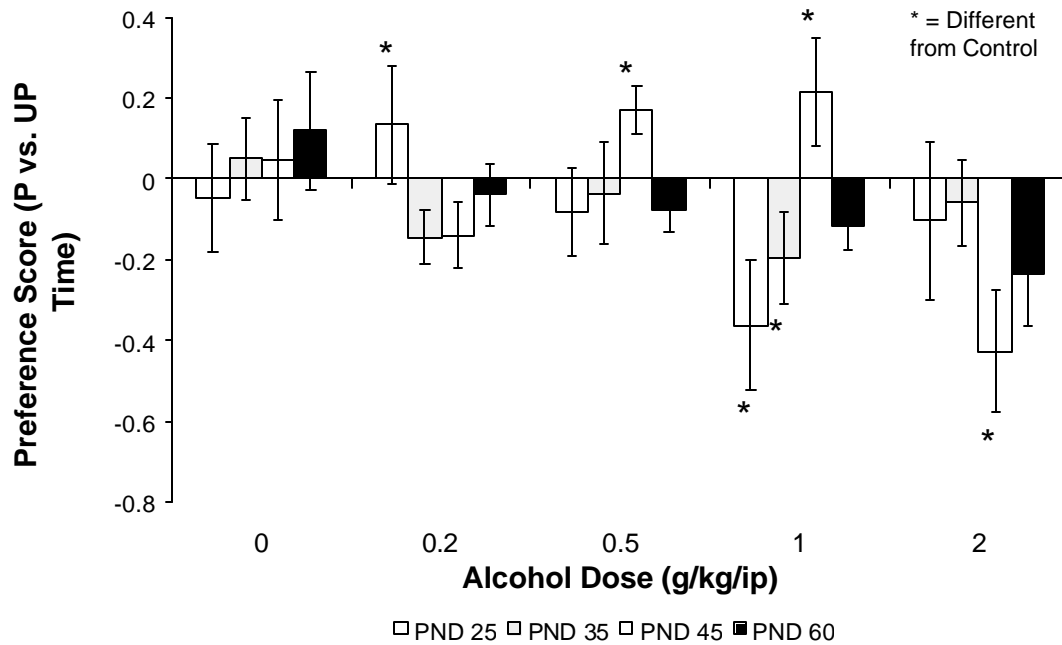

**Figure Two:** Preference scores were calculated as ratios of total time spent in the two conditioning chambers:  $(P - UP)/(P + UP)$ . Preference scores different ( $p < 0.05$ ) from zero were observed at 0.2 g/kg for PND 25 animals and 0.5 & 1.0 g/kg for PND 45 animals. Aversions relative to zero were observed at 1.0 g/kg for PND 25 and 35 animals and 2.0 for PND 45 animals.

**Discussion**

The use of chamber entries as a measure of activity in control animals revealed that adult animals were more active during testing than adolescent animals and that adolescent animals were, in turn more active than preadolescent animals. While the

PND 60 animals exhibited more chamber entries, this effect is due to the fact that they spent less time in the neutral zone and more time in the end chambers relative to other ages. Preference scores were determined to control for this finding given that they are unaffected by time in the neutral zone. We have recently examined activity in saline-injected control animals and found that all ages exhibited equivalent velocity and total distance traveled scores. In this study, adult animals again exhibited more chamber entries and interestingly the adolescent animals spent more time in the novel neutral zone (manuscript in preparation). Together these findings suggest that using chamber entries as a measure of activity per se, may not be useful in ontogenetic studies. The results of the present study reveal that PND 45 rats are unique in their responsiveness to alcohol, preferring doses that are non-preferred or aversive in younger and older animals. Postnatal day 25 animals exhibited a place preference for the alcohol paired chamber when conditioned with the 0.2 g/kg dose of ethanol only, while 45 day olds exhibited preferences at both the 0.5 and 1.0 g/kg doses. No other age by dose relationship produced an alcohol-related CPP. This demonstrates that these ages are unique in reactivity to alcohol, as the general finding in non-selectively bred animals is an alcohol induced aversion (Morse et al., 2000, Cunningham and Henderson, 2000, Gauvin et al., 1994, Stewart and Grupp, 1986, Stewart and Grupp, 1989), as seen in our PND 60 animals. Low and moderate doses of alcohol vary in their ability to establish a preference as a function of age suggesting that the process of development itself can contribute powerfully to the reinforcing aspects of alcohol. Further, since alcohol was aversive at all doses in adult animals these data suggest that adolescence, the age of initiation at greatest

risk for sustained alcohol use, is a critical period. Delayed initiation of alcohol intake may be protective in the absence of other intervening psychosocial variables.

The dose of 1.0 g/kg produced the most dramatic spread of behavior across ages, with all ages exhibiting a unique conditioned response. Postnatal day 45 animals exhibited a preference for the drug-paired chamber while PND 60, PND 35 and PND 25 animals exhibited increasing degrees of aversion, making this moderate dose optimal for further examination of age-related alcohol effects. Interestingly, prior data from our lab has shown that PND 25 animals exhibit significant increases in NAcc DA when given 1.0 g/kg of ethanol i.p. (Philpot and Kirstein, 1998). Viewing dopaminergic activity in the NAcc as strictly mediating reward, these data would appear to be in conflict with the alcohol place aversion observed at this age. However if DAergic activity is viewed as mediating reinforcement by way of increasing environmental salience of both appetitive and aversive stimuli this conflict does not occur. For example, the strength of the association (as measured by the stimuli's influence on behavior), and not the direction of the association, would be intertwined with NAcc DA concentrations, while some other system(s) may mediate the emotional valence of the stimulus in question. If this is the case DAergic responses to 1.0 g/kg would be largest in the PND 25 animals (mean preference score of -0.363), followed by the PND 35 and PND 45 animals (preference of -0.197 and 0.215 respectively) and smallest in PND 60 animals (-0.115). Preliminary data from our lab confirm this hypothesis. Acute administration of 1.0 g/kg ethanol in PND 25 animals does indeed produce the largest relative elevations in accumbal DA, with PND 35 and 45 animals intermediate and PND 60 animals exhibiting the smallest relative increases among these ages. Importantly, PND 45 animals appear unique,

demonstrating a lack of DAergic tolerance to repeated 1.0 g/kg ethanol administration (Kirstein and Philpot, 2002). The present data suggest increased risk to the reinforcing aspects of alcohol for adolescents when compared to young adults and these effects do not appear to be mediated by metabolic processes as evidenced in research by Silveri and Spear (Silveri and Spear, 1999, Silveri and Spear, 2000). Although other studies have been able to produce a CPP in adult animals, these studies usually involve extensive training or a preexposure period to reduce the aversive properties of ethanol (Gauvin and Holloway, 1992). By contrast, the present study demonstrates a rapid place conditioning in late adolescence. Specifically, a CPP occurred in a period of 4 days without the aid of a preexposure phase, indicating a unique susceptibility. Further, this study replicates results in adults consistent with reports of an ethanol-induced aversion (Heinrichs et al., 1995, Morse et al., 2000, Cunningham and Henderson, 2000, Cunningham et al., 1998, Gauvin et al., 1994, Holloway et al., 1992, Stewart and Grupp, 1986, Stewart and Grupp, 1989) further validating the unique nature of the PND 45 animals.

The implication is clear, adolescence represents a unique risk period for alcohol addiction. Data from the Monitoring the Future Studies (Johnston et al., 2002), and The National Center on Addiction and Substance Abuse (Califano, 2002) have suggested adolescence as a risk period based on population data. The present data confirm observations made in the human population and further, because this is an animal model of addiction, suggest the distinct possibility that basic biological factors may be fundamental in the manifestation of adolescent alcohol use and subsequent addiction. The results suggest the possibility that the biological transition that occurs during adolescence may manifest itself, in part, as increased preference for the appetitive aspects

of alcohol. This could result in an increased probability of initiation/use. Further, given the substantial amount of data that suggests higher risk of alcoholism in those initiating alcohol use in adolescence (DeWit et al., 2000, De Wit et al., 1999, Grant and Dawson, 1998, Hawkins et al., 1992, Hawkins et al., 1997, Guo et al., 2000); it is important to determine how alcohol exposure during this time alters the systems which mediate alcohol induced reinforcement. The present study demonstrates that reinforcement mechanisms do not function identically in late adolescent and young adult animals. Alcohol use during this critical period likely alters the natural transition of these reinforcement mechanisms as adulthood approaches. Studies examining the effects of repeated drug exposure on the subsequent responsiveness of the adolescent mesolimbic DA system are currently being examined in our laboratory.



## References

- Adriani, W., Chiarotti, F. and Laviola, G. (1998) Elevated novelty seeking and peculiar d-amphetamine sensitization in periadolescent mice compared with adult mice. *Behav Neurosci*, 112, 1152-66.
- Andersen, S. L. and Teicher, M. H. (2000) Sex differences in dopamine receptors and their relevance to ADHD. *Neurosci Biobehav Rev*, 24, 137-41.
- Bauer, R. and Evey, L. (1981) Differential effects of amphetamine on ontogeny of active avoidance, intertrial responses, and locomotor activity. *Psychopharmacology*, 75, 299-304.
- Bergman, J., Madras, B. K., Johnson, S. E. and Spealman, R. D. (1989) Effects of cocaine and related drugs in nonhuman primates. III. Self-administration by squirrel monkeys. *J Pharmacol Exp Ther*, 251, 150-5.
- Bolanos, C. A., Garmsen, G. M., Clair, M. A. and McDougall, S. A. (1996) Effects of the kappa-opioid receptor agonist U-50,488 on morphine-induced place preference conditioning in the developing rat. *Eur J Pharmacol*, 317, 1-8.
- Bolanos, C. A., Glatt, S. J. and Jackson, D. (1998) Subsensitivity to dopaminergic drugs in periadolescent rats: a behavioral and neurochemical analysis. *Brain Res Dev Brain Res*, 111, 25-33.
- Bronstein, P. M. (1972) Repeated trials with the albino rat in the open field as a function of age and deprivation. *J Comp Physiol Psychol*, 81, 84-93.
- Califano, J. A. (2002), *The National Center on Addiction and Substance Abuse at Columbia University*, New York.
- Campbell, J. O., Wood, R. D. and Spear, L. P. (2000) Cocaine and morphine-induced place conditioning in adolescent and adult rats. *Physiol Behav*, 68, 487-93.
- Carelli, R. M., Ijames, S. G. and Crumling, A. J. (2000) Evidence that separate neural circuits in the nucleus accumbens encode cocaine versus "natural" (water and food) reward. *J Neurosci* 20, 4255-66.
- Carr, G. D., Fibiger, H. C. and Phillips, A. G. (1989) In *The Neuropharmacological Basis of Reward* (Eds, Liebman, J. M. and Cooper, S. J.) Clarendon Press, Oxford, pp. 264-319.
- Ciccocioppo, R., Panocka, I., Froidi, R., Quitadamo, E. and Massi, M. (1999) Ethanol induces conditioned place preference in genetically selected alcohol-preferring rats. *Psychopharmacology (Berl)*, 141, 235-41.
- Crews, F. T., Braun, C. J., Hoplight, B., Switzer, R. C., 3rd and Knapp, D. J. (2000) Binge ethanol consumption causes differential brain damage in young adolescent rats compared with adult rats. *Alcohol Clin Exp Res*, 24, 1712-23.
- Cunningham, C. L., Hallett, C. L., Niehus, D. R., Hunter, J. S., Nouth, L. and Risinger, F. O. (1991) Assessment of ethanol's hedonic effects in mice selectively bred for sensitivity to ethanol-induced hypothermia. *Psychopharmacology*, 105, 84-92.

- Cunningham, C. L. and Henderson, C. M. (2000) Ethanol-induced conditioned place aversion in mice. *Behav Pharmacol*, 11, 591-602.
- Cunningham, C. L., Henderson, C. M. and Bormann, N. M. (1998) Extinction of ethanol-induced conditioned place preference and conditioned place aversion: effects of naloxone. *Psychopharmacology (Berl)*, 139, 62-70.
- De Wit, M. L., Embree, B. G. and De Wit, D. (1999) Determinants of the risk and timing of alcohol and illicit drug use onset among natives and non-natives: similarities and differences in family attachment processes. *Soc Biol*, 46, 100-21.
- DeWit, D. J., Adlaf, E. M., Offord, D. R. and Ogborne, A. C. (2000) Age at first alcohol use: a risk factor for the development of alcohol disorders. *Am J Psychiatry*, 157, 745-50.
- Di Chiara, G. and Imperato, A. (1988) Drugs abused by humans preferentially increase synaptic dopamine concentrations in the mesolimbic system of freely moving rats. *Proc Natl Acad Sci U S A*, 85, 5274-8.
- Engleman, E. A., McBride, W. J., Wilber, A. A., Shaikh, S. R., Eha, R. D., Lumeng, L., Li, T. K. and Murphy, J. M. (2000) Reverse microdialysis of a dopamine uptake inhibitor in the nucleus accumbens of alcohol-preferring rats: effects on dialysate dopamine levels and ethanol intake. *Alcohol Clin Exp Res*, 24, 795-801.
- Gauvin, D. V., Briscoe, R. J., Goulden, K. L. and Holloway, F. A. (1994) Aversive attributes of ethanol can be attenuated by dyadic social interaction in the rat. *Alcohol*, 11, 247-51.
- Gauvin, D. V. and Holloway, F. A. (1992) Historical factors in the development of ETOH-conditioned place preference. *Alcohol*, 9, 1-7.
- Glautier, S. (2000) Cravings and drug use. *Addiction*, 95, 1107.
- Goldman, M. (2002) Expectancy and risk for alcoholism: The unfortunate exploitation of a fundamental characteristic of neurobehavioral adaptation. *Alcohol: Clin and Exp Res*, 26, 737-746.
- Grant, B. F. and Dawson, D. A. (1998) Age of onset of drug use and its association with DSM-IV drug abuse and dependence: results from the National Longitudinal Alcohol Epidemiologic Survey. *J Subst Abuse*, 10, 163-73.
- Guo, J., Collins, L. M., Hill, K. G. and Hawkins, J. D. (2000) Developmental pathways to alcohol abuse and dependence in young adulthood. *J Stud Alcohol*, 61, 799-808.
- Hawkins, J. D., Catalano, R. F. and Miller, J. Y. (1992) Risk and protective factors for alcohol and other drug problems in adolescence and early adulthood: implications for substance abuse prevention. *Psychol Bull*, 112, 64-105.
- Hawkins, J. D., Graham, J. W., Maguin, E., Abbott, R., Hill, K. G. and Catalano, R. F. (1997) Exploring the effects of age of alcohol use initiation and psychosocial risk factors on subsequent alcohol misuse. *J Stud Alcohol*, 58, 280-90.

- Heinrichs, S. C., Menzaghi, F., Schulteis, G., Koob, G. F. and Stinus, L. (1995) Suppression of corticotropin-releasing factor in the amygdala attenuates aversive consequences of morphine withdrawal. *Behav Pharmacol*, 6, 74-80.
- Hernandez, L. and Hoebel, B. G. (1988) Food reward and cocaine increase extracellular dopamine in the nucleus accumbens as measured by microdialysis. *Life Sci*, 42, 1705-12.
- Holloway, F. A., King, D. A., Bedingfield, J. B. and Gauvin, D. V. (1992) Role of context in ethanol tolerance and subsequent hedonic effects. *Alcohol*, 9, 109-16.
- Hubner, C. B. and Koob, G. F. (1990) The ventral pallidum plays a role in mediating cocaine and heroin self-administration in the rat. *Brain Res*, 508, 20-9.
- Infurna, R. N. and Spear, L. P. (1979) Developmental changes in amphetamine-induced taste aversions. *Pharmacol Biochem Behav*, 11, 31-5.
- Johanson, C. E. and Schuster, C. R. (1975) A choice procedure for drug reinforcers: cocaine and methylphenidate in the rhesus monkey. *J Pharmacol Exp Ther*, 193, 676-88.
- Johnston, L. D., O'Malley, P. M. and Bachman, J. G. (2002), National Institute on Drug Abuse, Bethesda, MD, pp. NIH Publication No. 02-5105.
- Kandel, D. B. (1980) Drug use by youth: an overview. *NIDA Res Monogr*, 38, 1-24.
- Katner, S. N. and Weiss, F. (2001) Neurochemical characteristics associated with ethanol preference in selected alcohol-preferring and -nonpreferring rats: a quantitative microdialysis study. *Alcohol Clin Exp Res*, 25, 198-205.
- Kelley, B. M., Bandy, A. L. and Middaugh, L. D. (1997) A study examining intravenous ethanol-conditioned place preference in C57BL/6J mice. *Alcohol Clin Exp Res*, 21, 1661-6.
- Kirstein, C. L. and Philpot, R. M. (2002) In *Society For Neuroscience, 30th Annual Meeting*, Vol. 28 Orlando, pp. (Submitted).
- Klebaour, J. E. and Bardo, M. T. (1999) Individual differences in novelty seeking on the playground maze predict amphetamine conditioned place preference. *Pharmacol Biochem Behav*, 63, 131-6.
- Klebaour, J. E., Bevins, R. A., Segar, T. M. and Bardo, M. T. (2001) Individual differences in behavioral responses to novelty and amphetamine self-administration in male and female rats. *Behav Pharmacol*, 12, 267-75.
- Koob, G. F. (1992) Neural mechanisms of drug reinforcement. *Ann N Y Acad Sci*, 654, 171-91.
- Kuhar, M. J., Ritz, M. C. and Boja, J. W. (1991) The dopamine hypothesis of the reinforcing properties of cocaine. *Trends Neurosci*, 14, 299-302.
- Lanier, L. P. and Isaacson, R. L. (1977) Early developmental changes in the locomotor response to amphetamine and their relation to hippocampal function. *Brain Res*, 126, 567-75.

- Morse, A. C., Schulteis, G., Holloway, F. A. and Koob, G. F. (2000) Conditioned place aversion to the "hangover" phase of acute ethanol administration in the rat. *Alcohol*, 22, 19-24.
- Myers, M. G., Brown, S. A. and Mott, M. A. (1995) Preadolescent conduct disorder behaviors predict relapse and progression of addiction for adolescent alcohol and drug abusers. *Alcohol Clin Exp Res*, 19, 1528-36.
- Odell, W. D. (1990) In *Control of onset of puberty*. (Eds, Grumbach, M. M., Sizonenko, P. C. and Aubert, M. L.) Williams and Wilkins, Baltimore, pp. 183-210.
- Ojeda, S. R. and Urbanski, H. F. (1994) In *The Physiology of Reproduction*. (Eds, Knobil, E. and Neill, J. D.) Raven Press, New York, pp. 363-409.
- Philpot, R. M. and Kirstein, C. L. (1998) The effects of repeated alcohol exposure on the neurochemistry of the periadolescent nucleus accumbens septi. *Neuroreport*, 9, 1359-63.
- Primus, R. J. and Kellogg, C. K. (1989) Pubertal-related changes influence the development of environment-related social interaction in the male rat. *Dev Psychobiol*, 22, 633-43.
- Risinger, F. O., Malott, D. H., Prather, L. K., Niehus, D. R. and Cunningham, C. L. (1994) Motivational properties of ethanol in mice selectively bred for ethanol-induced locomotor differences. *Psychopharmacology (Berl)*, 116, 207-16.
- Schechter, M. D. (1992) Locomotor activity but not conditioned place preference is differentially affected by a moderate dose of ethanol administered to P and NP rats. *Alcohol*, 9, 185-8.
- Sherman, J. E., Pickman, C., Rice, A., Liebeskind, J. C. and Holman, E. W. (1980) Rewarding and aversive effects of morphine: temporal and pharmacological properties. *Pharmacol Biochem Behav*, 13, 501-5.
- Silveri, M. M. and Spear, L. P. (1999) Ontogeny of rapid tolerance to the hypnotic effects of ethanol. *Alcohol Clin Exp Res*, 23, 1180-4.
- Silveri, M. M. and Spear, L. P. (2000) Ontogeny of ethanol elimination and ethanol-induced hypothermia. *Alcohol*, 20, 45-53.
- Slawecki, C. J. (2002) Altered EEG responses to ethanol in adult rats exposed to ethanol during adolescence. *Alcohol Clin Exp Res*, 26, 246-54.
- Slawecki, C. J., Betancourt, M., Cole, M. and Ehlers, C. L. (2001) Periadolescent alcohol exposure has lasting effects on adult neurophysiological function in rats. *Brain Res Dev Brain Res*, 128, 63-72.
- Spear, L. P. (2000) The adolescent brain and age-related behavioral manifestations. *Neurosci Biobehav Rev*, 24, 417-63.
- Spear, L. P. and Brake, S. C. (1983) Periadolescence: age-dependent behavior and psychopharmacological responsivity in rats. *Dev Psychobiol*, 16, 83-109.

- Spear, L. P. and Brick, J. (1979) Cocaine-induced behavior in the developing rat. *Behav Neural Biol*, 26, 401-15.
- Spear, L. P., Shalaby, I. A. and Brick, J. (1980) Chronic administration of haloperidol during development: behavioral and psychopharmacological effects. *Psychopharmacology*, 70, 47-58.
- Spyraki, C., Fibiger, H. C. and Phillips, A. G. (1982a) Cocaine-induced place preference conditioning: lack of effects of neuroleptics and 6-hydroxydopamine lesions. *Brain Res*, 253, 195-203.
- Spyraki, C., Fibiger, H. C. and Phillips, A. G. (1982b) Dopaminergic substrates of amphetamine-induced place preference conditioning. *Brain Res*, 253, 185-93.
- Stanwood, G. D., McElligot, S., Lu, L. and McGonigle, P. (1997) Ontogeny of dopamine D3 receptors in the nucleus accumbens of the rat. *Neurosci Lett*, 223, 13-6.
- Stewart, J. (1984) Reinstatement of heroin and cocaine self-administration behavior in the rat by intracerebral application of morphine in the ventral tegmental area. *Pharmacol Biochem Behav*, 20, 917-23.
- Stewart, R. B. and Grupp, L. A. (1986) Conditioned place aversion mediated by orally self-administered ethanol in the rat. *Pharmacol Biochem Behav*, 24, 1369-75.
- Stewart, R. B. and Grupp, L. A. (1989) Conditioned place aversion mediated by self-administered ethanol in the rat: a consideration of blood ethanol levels. *Pharmacol Biochem Behav*, 32, 431-7.
- Tam, T. W., Weisner, C. and Mertens, J. (2000) Demographic characteristics, life context, and patterns of substance use among alcohol-dependent treatment clients in a health maintenance organization. *Alcohol Clin Exp Res*, 24, 1803-10.
- Tarazi, F. I. and Baldessarini, R. J. (2000) Comparative postnatal development of dopamine D(1), D(2) and D(4) receptors in rat forebrain. *Int J Dev Neurosci*, 18, 29-37.
- Teichman, M., Barnea, Z. and Rahav, G. (1989) Sensation seeking, state and trait anxiety, and depressive mood in adolescent substance users. *Int J Addict*, 24, 87-99.
- Weiss, F., Martin-Fardon, R., Ciccocioppo, R., Kerr, T. M., Smith, D. L. and Ben-Shahar, O. (2001) Enduring resistance to extinction of cocaine-seeking behavior induced by drug-related cues. *Neuropsychopharmacology*, 25, 361-72.
- White, A. M., Bae, J. G., Truesdale, M. C., Ahmad, S., Wilson, W. A. and Swartzwelder, H. S. (2002) Chronic-intermittent ethanol exposure during adolescence prevents normal developmental changes in sensitivity to ethanol-induced motor impairments. *Alcohol Clin Exp Res*, 26, 960-8.
- White, A. M., Ghia, A. J., Levin, E. D. and Swartzwelder, H. S. (2000) Binge pattern ethanol exposure in adolescent and adult rats: differential impact on subsequent responsiveness to ethanol. *Alcohol Clin Exp Res*, 24, 1251-6.

- Wise, R. A., Yokel, R. A. and DeWit, H. (1976) Both positive reinforcement and conditioned aversion from amphetamine and from apomorphine in rats. *Science*, 191, 1273-5.
- York, J. L. and Regan, S. G. (1982) Conditioned and unconditioned influences on body temperature and ethanol hypothermia in laboratory rats. *Pharmacol Biochem Behav*, 17, 119-24.
- Zuckerman, M., Ballenger, J. C. and Post, R. M. (1984) The neurobiology of some dimensions of personality. *Int Rev Neurobiol*, 25, 391-436.
- Zuckerman, M., Persky, H., Link, K. E. and Basu, G. K. (1968) Responses to confinement: an investigation of sensory deprivation, social isolation, restriction of movement and set factors. *Percept Mot Skills*, 27, 319-34.

## EFFECTS OF REPEATED ETHANOL ON BASAL DOPAMINE LEVELS

### **Abstract**

Recent research indicates that alcohol use/abuse is often initiated during the adolescent period and that brain reinforcement pathways [e.g., the mesolimbic dopamine (DA) pathway] are undergoing developmental transition. Our research focuses on the effects of ethanol administration on neural mechanisms associated with addiction in preadolescent (postnatal day; PND 25), adolescent (PND 35, PND 45) and young adult (PND 60) animals. Using conditioned place preference (CPP) testing we have shown that adolescent animals are unique in their responses to ethanol. CPP has been associated with contextually conditioned incentive motivation, our results suggest that younger animals may be more vulnerable to addiction. The present data reveal that adolescent animals are neurochemically distinct in response to ethanol's effects. Using *in vivo* microdialysis within the nucleus accumbens septi (NAcc) we have determined the dopaminergic (DAergic) response across development. Results reveal that the basal levels of DA transition during the adolescent period and differ from preadolescent or adult animals. Specifically, PND 45 animals exhibited significantly higher, and PND 25 significantly lower, basal DA levels than all other ages examined. Further, repeated exposure to ethanol elevated basal DA levels significantly regardless of age or dose. Basal DOPAC/DA ratio also differed as a function of age, with PND 35 and PND 60 animals

demonstrating the highest ratios, and PND 45 animals producing the lowest baseline levels. Repeated ethanol exposure produced significant changes in basal ratios as a function of age. Interestingly, PND 45 animals exhibited no change in ratios with repeated exposure, while all other ages demonstrated a dose dependent rise in DOPAC/DA ratios. These data indicate an age dependant difference in the homeostatic alterations of mesolimbic systems in response to repeated ethanol treatment, an effect that may manifest itself as differences in behavioral responsivity and conditionability to the alcohol and it's effects.



## **Introduction**

Adolescence is a complex developmental period involving increased socialization, risk taking, cognitive and sexual development and rapid growth. This period is characterized by exploring potentials, challenging protective barriers to transition from a dependent to an independent organism. A natural consequence of adolescence is tremendous experimentation and risk taking (for review see Spear, 2000) a pattern that, in the arena of drug abuse often manifests itself as first time drug use and the potential for drug abuse (Zuckerman 1974). Drug use typically begins early in the maturational process, increasing dramatically in adolescence. By twelfth grade, approximately 80.3% of U.S. adolescents have used alcohol at some time, an increase from 51.7% for 8<sup>th</sup> graders (Johnston 2000). Adult lifetime prevalence data indicate 81.3% have had some experience with alcohol, a rate only slightly higher than that reported for 12<sup>th</sup> graders, suggesting that during adolescence most individuals have their first experience with the drug. Of particular importance, the rate of initiation of alcohol use among the 12-17 year old age group has increased in recent years (SAMHSA 1999).

Developmental changes in the mesolimbic system, which projects from the ventral tegmental area (VTA) to the nucleus accumbens septi (NAcc), may mediate the behavioral changes associated with adolescence. Consequently increasing the probability of drug use initiation as well as potentiate the likelihood of abuse. It is clear that in both human and rodent populations, mesolimbic dopamine (DA) systems are undergoing tremendous transition. Basal DA synthesis in the NAcc is lower in postnatal day 30 (PND 30) than PND 40 rats and turnover rates for PND 30 animals are less than reported in adults (Andersen, Rutstein et al. 1997). DA receptor populations also change

exhibiting a pattern of overproduction and pruning across adolescence (Teicher, Andersen et al. 1995; Andersen, Rutstein et al. 1997; Andersen and Teicher 2000). This pattern is similar in humans as well (Seeman, Bzowej et al. 1987). In rats, the density of D1, D2, and D4 receptors in the NAcc increases to a peak at PND 28, and then declines significantly to adult levels at PND 60 (Tarazi and Baldessarini 2000). Parallel with these changes, DA transporter levels are undergoing substantial change, increasing in concentration in the NAcc to adult levels through adolescence (Coulter, Happe et al. 1996; Coulter, Happe et al. 1997).

The dynamic changes in the mesolimbic DA system during adolescence suggests that processes mediated by this system are unlikely to manifest themselves similarly in adults. Across adolescence there may be tremendous transitions in reactivity to stimuli (eg., drugs) that act on these systems. Particularly, developmental transitions in this pathway may mediate the increased likelihood of engaging in drug use initiation (risk taking) during adolescence. Thus, drugs of abuse may exhibit unique profiles of action in these systems during adolescence and resultantly increase the probability for the development of addiction among adolescents.

## **Methods**

To examine the influence of ethanol exposure on NAcc DA, animals were placed into one of two treatment conditions: acute or repeated ethanol, and administered one of five doses: saline, 0.2, 0.5, 1.0 or 2.0 g/kg ethanol (17% v/v). Neurochemical responses to treatment were measured using *in vivo* microdialysis following 4 days of treatment. Coordinates for probe placement in the NAcc of PND 25, 35, 45 and 60 animals were determined using weight based regression lines established in a prior study (Philpot,

McQuown et al. 2001). All animals received injections (b.i.d.) at one of 4 age ranges: 21-24 (preadolescent), 31-34, 41-44 (periadolescent) or 56-59 (young adult) to examine developmental differences in response profile. Four to eight animals were used per group, for a total of 315 animals.

The probe was perfused with artificial cerebrospinal fluid (145 mM NaCl, 2.4 mM KCl, 1.0 mM MgCl<sub>2</sub>, 1.2 mM CaCl<sub>2</sub>, and 0.2 mM ascorbate, pH = 7.4) at a flow rate of one  $\mu$ l/min and inserted (under anesthesia). Animals were placed within a BAS Return Apparatus overnight to allow for elimination of anesthetic. Sampling began 24 hr following placement of the probe. Samples were collected (1 $\mu$ l/min) every 10 min using a refrigerated fraction collector (BAS) and acidified with 0.25 N HClO<sub>4</sub>. A total of six baseline samples were collected the final three of which were used for the calculation of baseline levels. Drop sites were verified histologically to ensure placement in the NAcc shell region.

Extracellular levels of DA, and 3,4-dihydroxyphenylacetic acid (DOPAC) were determined using HPLC-EC. Direct injections of dialysis samples were separated by a Microbore HPLC system (BAS) with a mobile phase consisting of monochloroacetic acid (0.15 M), sodium octyl sulfate (0.50 mM), EDTA (1.0 mM) and acetonitrile (4.0%) (pH = 2.9). Peaks were detected using a BAS LC-4C electrochemical detector (Bioanalytical Systems, West Lafayette, IN) coupled to a radial flow electrode referenced at 0.800 V. Data were analyzed using a 4 (Age) x 2 (Treatment) x 4 (Dose) ANOVA with subsequent simple effects analyses and Fisher LSDs to isolate effects.

Figure One

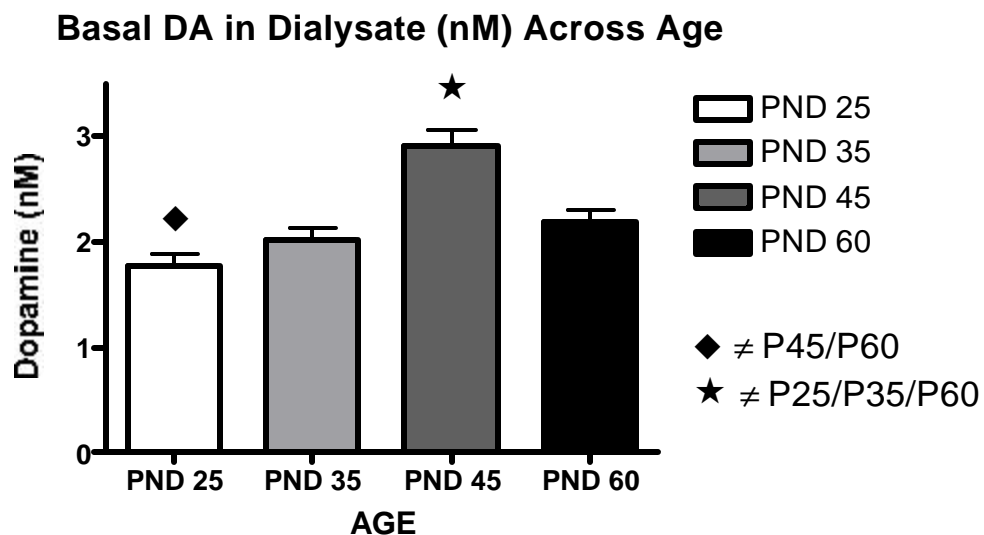

**Figure One:** Analysis of basal DA revealed a significant main effect of Age 3,279  $F = 17.171$ ,  $P < 0.05$ . Post Hoc analysis revealed that P25 animals exhibited significantly less basal DA in dialysate than PND 45 or PND 60, while PND 45 animals demonstrated higher basal levels than all other ages examined.

### Results and Discussion

The present findings indicate late adolescent animals (ie., PND 45) produce substantially greater quantities of DA in extracellular fluid than younger and older animals (Figure One). Given evidence suggesting that NAcc DA is related to both responsiveness to novel stimuli and to drug abuse liability, and that these two factors are correlated, it is reasonable to assume that differences in basal DA activity in the NAcc may manifest itself as transitional differences in behavior. The developmental elevation in DA may serve to produce the increased exploratory and risk-taking typically observed in adolescence. The present study shows a lack of alteration in DOPAC/DA turnover at this age (PND 45; Figure Two), suggesting a failure to adapt to repeated ethanol, or at a minimum a unique fashion of adaptation at this age that may result in increased reactivity

to ethanol following repeated use relative to other ages. Further, the unique status of the DA system during this time, coupled to its unique response to repeated ethanol, may result in a system that develops differentially as a result of alcohol exposure during adolescence. This may, in turn, increase the likelihood of long-term ethanol use, abuse and dependence.

Figure Two

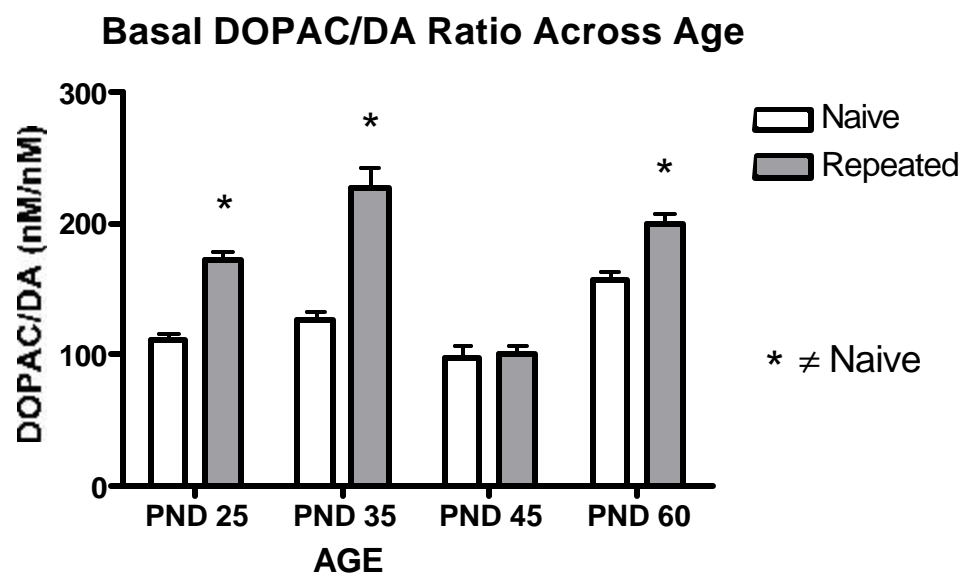

**Figure Two:** Analysis of basal DOPAC/DA ratio revealed a significant Age X Pretreatment interaction  $3, 279 F = 7.637, p < 0.05$ . Analysis of simple effects in Naïve animals revealed that PND 60 animals produce higher DOPAC/DA ratios than all other ages, and that PND 45. With Repeated exposure, PND 25 animals exhibited lower turnover values than PND 35 or PND 60, and PND 45 animals exhibited lower turnover than all ages. Importantly, PND 45 animals failed to demonstrate an elevation in DOPAC/DA ratio following repeated ethanol.

## References

- Andersen, S. L., M. Rutstein, et al. (1997). "Sex differences in dopamine receptor overproduction and elimination." Neuroreport **8**(6): 1495-8.
- Andersen, S. L. and M. H. Teicher (2000). "Sex differences in dopamine receptors and their relevance to ADHD." Neurosci Biobehav Rev **24**(1): 137-41.
- Coulter, C. L., H. K. Happe, et al. (1996). "Postnatal development of the dopamine transporter: a quantitative autoradiographic study [published erratum appears in Brain Res Dev Brain Res 1996 Jan 2;98(1):150]." Brain Res Dev Brain Res **92**(2): 172-81.
- Coulter, C. L., H. K. Happe, et al. (1997). "Dopamine transporter development in postnatal rat striatum: an autoradiographic study with [3H]WIN 35,428." Brain Res Dev Brain Res **104**(1-2): 55-62.
- Johnston, L. D. (2000). Monitoring the future : national survey results on drug use, 1975-1999. Bethesda, Md., National Institute on Drug Abuse, U.S. Dept. of Health and Human Services, National Institutes of Health.
- Philpot, R. M., S. McQuown, et al. (2001). "Stereotaxic localization of the developing nucleus accumbens septi." Brain Res Dev Brain Res **130**(1): 149-53.
- SAMHSA (1999). Summary of findings from the 1998 national household survey on drug abuse. Rockville, Md, U.S. Dept. of Health and Human Services: 128.
- Seeman, P., N. H. Bzowej, et al. (1987). "Human brain dopamine receptors in children and aging adults." Synapse **1**(5): 399-404.
- Spear, L. P. (2000). "The adolescent brain and age-related behavioral manifestations [In Process Citation]." Neurosci Biobehav Rev **24**(4): 417-63.
- Tarazi, F. I. and R. J. Baldessarini (2000). "Comparative postnatal development of dopamine D(1), D(2) and D(4) receptors in rat forebrain." Int J Dev Neurosci **18**(1): 29-37.
- Teicher, M. H., S. L. Andersen, et al. (1995). "Evidence for dopamine receptor pruning between adolescence and adulthood in striatum but not nucleus accumbens." Brain Res Dev Brain Res **89**(2): 167-72.
- Zuckerman, M. (1974). "The sensation seeking motive." Prog Exp Pers Res **7**: 79-148.

## **ETHANOL MEDIATED DOPAMINE RELEASE IN THE NUCLEUS ACCUMBENS SEPTI OF ADOLESCENT ANIMALS**

### **Abstract**

The mesolimbic dopamine (DA) system has been implicated as central to motivated behaviors. This system has been demonstrated to mediate the motivational aspects of natural reinforcers. It is now well known that DA activity increases in the nucleus accumbens septi (NAcc) with exposure to addictive substances and manipulation of this response alters the motivational capacity of drugs of abuse. Recent research has revealed that the mesolimbic system of periadolescent animals is undergoing dramatic transition in functional tone. DA receptor and transporter levels are up regulated, synthesis rates are altered, and innervation from prefrontal cortex (PFC), involved in regulating tonic and phasic DA activity, is increasing. Consequently, during adolescence there is a dramatic change in tonic DA levels, variations in phasic responses to acute drug administration and alterations in how the system adapts to repeated drug exposure. These data suggests that adolescents may be particularly susceptible to addiction. The present study examined the responsiveness of the NAcc to the administration of ethanol in adolescent and adult animals. The results indicate that adolescents are different from adults in their neurochemical responsiveness to alcohol and suggest that late adolescent animals are particularly vulnerable to the rewarding effects of repeated ethanol administration.

## **Introduction**

Drug use typically begins early in the maturational process and increases dramatically in adolescence. Adult lifetime prevalence data indicate 81.3% have had some experience with alcohol, a rate only slightly higher than that reported for high school students in 12<sup>th</sup> grade, suggesting that during adolescence most individuals have their first experience with the drug. Approximately 10.7 million people aged 12 to 20 were current alcohol users in 2002. From 12 years to 17 years of age current use rates for alcohol increased from 2.6% to 36.2% (SAMHSA 2003b). Within the ages 12 to 15 rates of recent alcohol use increased to 21.5%, increasing to more than 8 times in a four year span (SAMHSA 2003a). Of particular importance, the numbers of initial alcohol users among the 12-17 year old age group increased from 2.2 to 3.1 million between 1995 and 2000 revealing a recent rise in the initiation of use in the adolescent population (SAMHSA 2003c). These data indicate both a significant initiation of use in early adolescence as well as a rapid increase in using during the adolescent period.

Adolescence is a complex developmental period involving increased socialization, risk taking, cognitive development, sexual development and rapid growth. Its temporal boundaries are difficult to define as adolescence involves the occurrence of a range of events over a broad period. In humans, adolescence is a period in which the developing organism begins to explore potentials, to challenge protective barriers and structure in order to transition from a dependent child to an independent adult (Spear 2000a). A natural consequence of this developmental strategy is tremendous experimentation and risk taking a pattern that can manifest itself as first time drug use and subsequent drug abuse (Zuckerman 1974).



Interestingly, many of the biological and behavioral characteristics of human adolescence are paralleled in the rodent population. O'dell (1990) has defined the period of adolescence in the rat as between PND 20 and 55 based on hormonal changes associated with sexual development. During this broad timeframe, behavioral characteristics emerge that are similar to those observed in the human adolescent. Rodents increase play behavior with conspecifics during this time and show increased activity and exploratory behavior. Continuing development of the central nervous system (CNS) may underlie observed behavioral changes in both humans and rodents (Spear 2000b).

The CNS structure most frequently implicated in mediating addictive processes is the nucleus accumbens septi (NAcc), which receives dopaminergic (DAergic) input from the ventral tegmental area (VTA). Manipulations that directly stimulate dopamine (DA) receptors in the NAcc reinforce many behaviors (Olds and Fobes 1981) including place preference and lever pressing. Electrical stimulation of the NAcc itself, or any of the pathways which result in increased DA efflux within the NAcc, produce behavioral reinforcement and animals will lever press for this stimulation (Crow 1971; Anlezark et al. 1972; Crow 1972, 1973; Anlezark et al. 1974). Additionally, injections of DA agonists into the NAcc have rewarding effects, producing a conditioned place preference (CPP) in treated animals (Hoebel et al. 1983). Animals will also lever press for microinjections of DA or amphetamine directly into the NAcc (Hoebel et al. 1983) indicating that drug stimulation of this region is sufficient to establish and maintain stimulant use. This region also appears to be directly involved in the reinforcing effects of cocaine (Moghaddam and Bunney 1989) and the administration of numerous drugs,

including alcohol, all elicit a significant increase in DA levels in the NAcc (Phillips et al. 1983; Koob 1992a, 1992b, 1992c, 1996b, 1996a; Phillips and Shen 1996). Decreasing DA release in the NAcc results in higher stimulation thresholds for electrical brain self-stimulation, mimicking the effect of systemic administration of DA antagonists. Direct injections of DA receptor blockers into the NAcc necessitate a large increase in the amount of electrical stimulation necessary to maintain self-stimulation behavior (Stellar et al. 1983). Additionally, experiments using animals which are trained to self-administer cocaine or amphetamine have shown that microinjections of DA antagonists (directly into the NAcc) decrease self-administration (Koob 1992a) when administered in sufficient quantities. Moreover, following 6-hydroxydopamine (6-OHDA) lesions, animals will no longer lever press to administer the DAergic agonists cocaine or amphetamine (Zito et al. 1985; Roberts 1989). However, they will vigorously respond if apomorphine (DA receptor agonist) is infused into the NAcc during the self-administration procedure, producing post-synaptic activity despite the lesion. Taken together, these studies show the central role that DA activation of the postsynaptic receptors of the NAcc plays in a broad range of reinforcing behaviors.

It is likely that neurophysiological changes in the mesolimbic system during development modulate the initiation of drug use and potentiate the likelihood of abuse during adolescence. Specifically, it is clear in both human and rodent populations that the mesolimbic DA systems are undergoing tremendous transition during adolescence. Neurochemically, basal DA synthesis in the NAcc is lower in postnatal day 30 (PND 30) than PND 40 rats and turnover rates for PND 30 animals are less than those reported in adults (Andersen et al. 1997). Research on DA receptor populations indicates a pattern of

overproduction and pruning that occurs across adolescence in a sex-specific manner (Teicher et al. 1995; Andersen et al. 1997; Andersen and Teicher 2000) with males exhibiting greater levels across age and greater over production of D1 and D2 receptor types. This pattern is similar in humans as well (Seeman et al. 1987). In rats, the density of D1, D2, and D4 receptors in the NAcc increases to peak at PND 28, and then declines significantly to adult levels at PND 60 (Tarazi and Baldessarini 2000). Furthermore, D3 receptor numbers appear to increase monotonically, with some reports finding adult levels at weaning (i.e., PND 21) (Demotes-Mainard et al. 1996) but others find D3 levels in weanlings far lower than those observed in adults (Stanwood et al. 1997). In conjunction with receptor density changes, D1 stimulatory and D2 inhibitory effects on adenylyl cyclase production are less apparent in adolescence than in adults (Andersen and Teicher 1999). Simultaneously, DA transporter levels are undergoing substantial change, increasing in concentration in the NAcc to adult levels through adolescence (Coulter et al. 1996, 1997). This dynamic transition during adolescence suggests that processes that are mediated by the mesolimbic DA system are unlikely to manifest themselves similarly in adults and adolescents and that across adolescence there may be tremendous transitions in reactivity to stimuli that act on these systems. Of particular importance, developmental transitions in this system may mediate the increased likelihood of engaging in drug use (risk taking) during adolescence and drugs of abuse may exhibit unique profiles of action in these systems during adolescence that underlie the increased probability for the development of addiction among adolescents. The present study utilized in vivo microdialysis to examine ethanol's effects on DA levels in the NAcc of adolescent and adult animals.

## Methods

### Animals

One hundred ninety two rats (Zivic Miller Laboratories) weighing from 50 - 300 g (PND 25, 60-90g; PND 35, 120-160g; PND 45, 180-240; PND 60, 220-350g) at the time of dialysis were used in this study. No more than one male and one female per litter were used in a given condition. Pups were sexed and culled to 10 pups per litter on postnatal day one (PND 1). Pups remained housed with their respective dams in a temperature and humidity-controlled vivarium on a 12:12h light: dark cycle (07:00h/19:00h). On PND 21, pups were weaned and pair housed.

### Surgery

Our laboratory has recently determined the effective coordinates for microdialysis probe placement in PND 25, 35, 45 and 60 animals (Philpot et al. 2001) for use in these procedures. Preadolescent (i.e., PND 24), periadolescent (i.e., PND 34, 44) and adult (PND 59) animals were anesthetized using a xylazine/ketamine cocktail (0.15 and 1.0 mg/kg respectively). An incision was made over the skull, the guide cannula affixed with cyanoacrylate and cranioplast and the dialysis probe lowered to the NAcc shell. Anchor screws were used to insure sufficient support and topical lidocaine was applied to the wound edge to reduce potential discomfort. The probe was perfused with artificial cerebrospinal fluid (145 mM NaCl, 2.4 mM KCl, 1.0 mM MgCl<sub>2</sub>, 1.2 mM CaCl<sub>2</sub>, and 0.2 mM ascorbate, pH = 7.4) at a flow rate of one  $\mu$ l/min and inserted (under anesthesia) following solidification of the cranioplast. Animals were placed within a BAS Return Apparatus overnight to allow for elimination of anesthetic.

Sampling began 24 hr following placement of the probe. Six baseline samples were collected prior to drug manipulation, the final three of which were used for the

calculation of baseline levels. After the collection of baseline samples animals received an injection of saline or drug (as outlined in the specific experiments below). Samples were collected (1 $\mu$ l/min) every 10 min for a total duration of 120 min after injection (60 minutes prior to injection) using a refrigerated fraction collector (BAS) and acidified with 0.25 N HClO<sub>4</sub>. Animals were overdosed with Nembutal (80 mg/kg), decapitated, the probe removed and the brain frozen for sectioning to verify probe placement in the NAcc shell region.

#### Dialysate Analysis

Extracellular levels of DA and the metabolite 3,4-dihydroxyphenylacetic acid (DOPAC) were determined using High Performance Liquid Chromatography with Electrochemical Detection (HPLC-EC). After acidification, samples were run or stored at -80<sup>o</sup> c. Direct injections of dialysis samples were separated by a Microbore HPLC system (BAS) with a mobile phase consisting of monochloroacetic acid (0.15 M), sodium octyl sulfate (0.50 mM), EDTA (1.0 mM) and acetonitrile (4.0%) (pH = 2.9). Peaks were detected using a BAS LC-4C electrochemical detector (Bioanalytical Systems, West Lafayette, IN) coupled to a radial flow electrode referenced at 0.800 V. Peak detection limits for catechols using this system is 150 fg injected (Pers. Comm., BAS) at 1 nA sensitivity with peak signal to noise ratio of at least 2:1. The recoveries of DA and DOPAC through the dialysis membrane are 10-20% as measured *in vitro* at 23<sup>o</sup> C.

#### Ethanol-Induced NAcc DA Release Across Age

To examine the responsivity, tolerance and conditionability of the developing NAcc to alcohol, animals were placed into one of three treatment conditions: acute, repeated or expectancy, at one of four doses: saline, 0.5, 1.0 or 2.0 g/kg alcohol, and neurochemical responses were measured. All animals received injections (b.i.d.) in one

of 4 ages: 21-25 (preadolescent), 31-35, 41-45 (periadolescent) or 56-60 (young adult) to examine developmental differences in response profile. Four animals were used per group, for a total of 192 animals. Animals in the acute condition received injections (b.i.d.) of saline followed by a drug challenge at the respective dose on the day of dialysis. Animals in the repeated condition received repeated drug injections and received the respective dose on the day of testing. Animals in the expectancy condition received repeated drug injections and were challenged with saline in the environment previously paired with ethanol on the day of testing

Basal differences in nM concentrations were analyzed with a 4 (Age) x 4 (Dose) ANOVA to determine age related and drug exposure induced changes in DA and DOPAC. Drug effects on DA and DOPAC were analyzed using 4 (Age) x 4 (Dose) Area Under the Curve (AUC) analysis of both absolute (nM) and percent relative to baseline response profiles. Temporal drug effects on DA and DOPAC were analyzed using a 4 (Age) x 3 (Treatment) x 4 (Dose) x 13 (Time) factorial ANOVA with subsequent Newman-Keuls planned comparisons to isolate effects over time.

## **Results**

### Basal Levels

#### *DOPAC*

Analysis of basal DOPAC revealed significant main effects of Age 3,279  $F = 6.887$ ,  $P < 0.05$ ; Pretreatment 1,279  $F = 49.251$ ,  $p < 0.05$ ; and Dose 4, 279  $F = 2.719$ ,  $p < 0.05$ . A significant Dose X Pretreatment interaction 3, 279  $F = 3.690$ ,  $p < 0.05$  was also observed.

# Figure One: Basal DOPAC Levels in the NAcc

A.

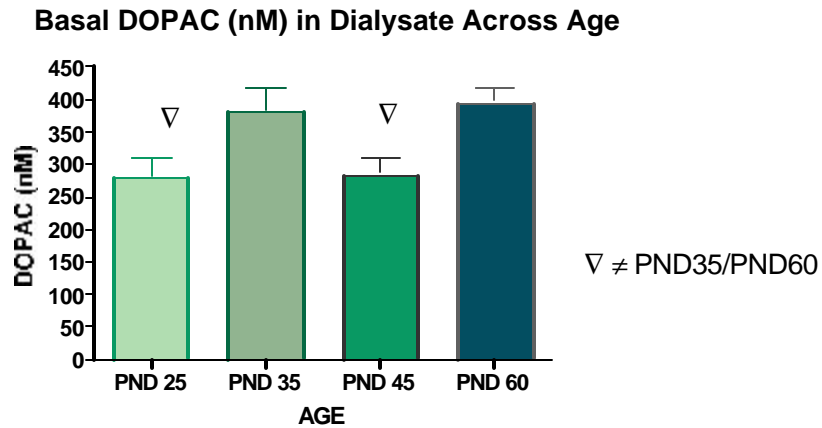

B.

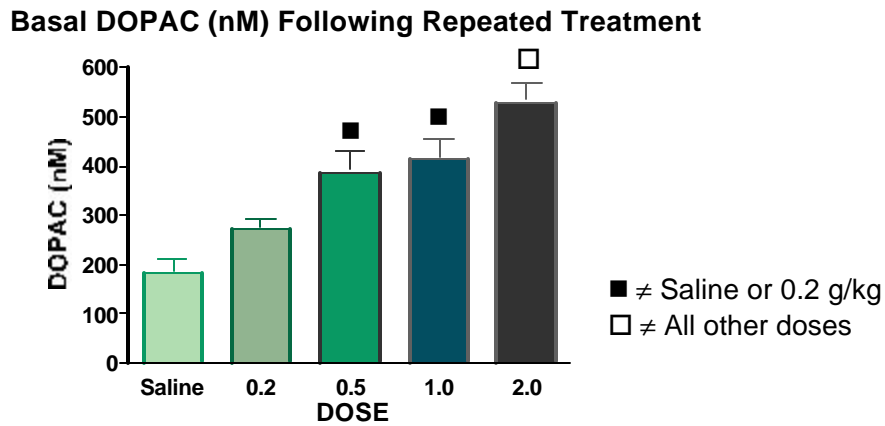

**Figure One:** PND 25 and PND 45 animals possessed significantly less DOPAC in dialysate than their PND 35 and PND 60 counterparts (A). Following Repeated treatment with 0.5, 1.0 or 2.0 g/kg EtOH DOPAC levels were elevated over Saline or 0.2 g/kg EtOH treated animals. 2.0 g/kg treatment produced elevations over 0.5 and 1.0 g/kg EtOH (B).

Post Hoc analysis demonstrated that PND 25 and PND 45 animals possessed significantly less DOPAC in dialysate than their PND 35 and PND 60 counterparts (Figure One: A).

Analysis of simple effects revealed that following Repeated treatment with 0.5, 1.0 or 2.0 g/kg EtOH DOPAC levels were elevated over Saline or 0.2 g/kg EtOH treated animals. Further, 2.0 g/kg treatment produced elevations over 0.5 and 1.0 g/kg EtOH (Figure One: B).

#### *DA*

Analysis of basal DA revealed significant main effects of Age 3,279  $F = 17.171$ ,  $P < 0.05$ ; and Pretreatment 1, 279  $F = 28.071$ ,  $p < 0.05$ .

Post Hoc analysis revealed that PND 25 animals exhibited significantly less basal DA in dialysate than PND 45 or PND 60, while PND 45 animals demonstrated higher basal levels than all other ages examined (Figure Two: A). Additionally, animals pretreated with alcohol (Repeated and Expectancy groups) demonstrated higher basal levels than those receiving only saline during the pretreatment phase (Figure Two: B).

#### *DOPAC/DA*

Analysis of basal DOPAC/DA ratio revealed significant main effects of Age 3,279  $F = 30.728$ ,  $P < 0.05$ ; Pretreatment 1, 279  $F = 48.495$ ,  $p < 0.05$  and Dose 4, 279  $F = 4.248$ ,  $p < 0.05$ ; a significant Age X Pretreatment 3, 279  $F = 7.637$ ,  $p < 0.05$  and Dose X Pretreatment interaction 3,279  $F = 3.589$ ,  $p < 0.05$ . Post Hoc analysis revealed that PND 45 animals had significantly lower DOPAC/DA ratios than all other ages, and that PND 25 animals demonstrated lower ratios than PND 35 or PND 60 (Figure Three: A).



## Figure Two: Basal DA Levels in the NAcc

A.

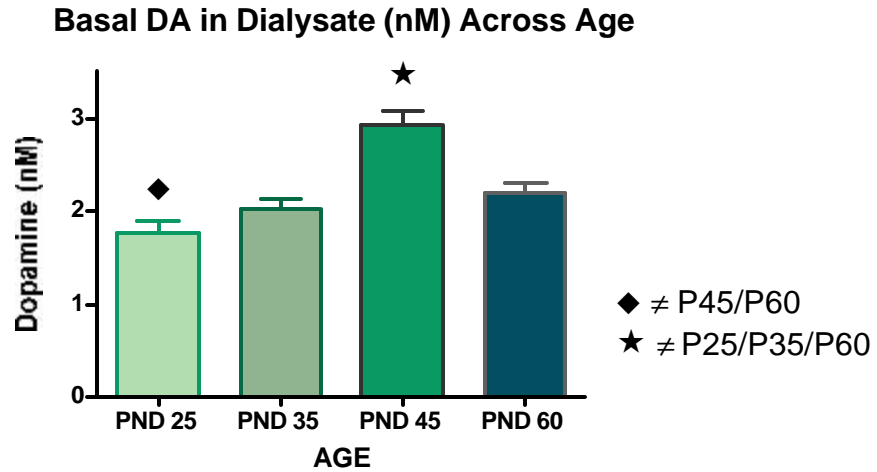

B.

### Basal DA in Dialysate (nM) Following Repeated Ethanol

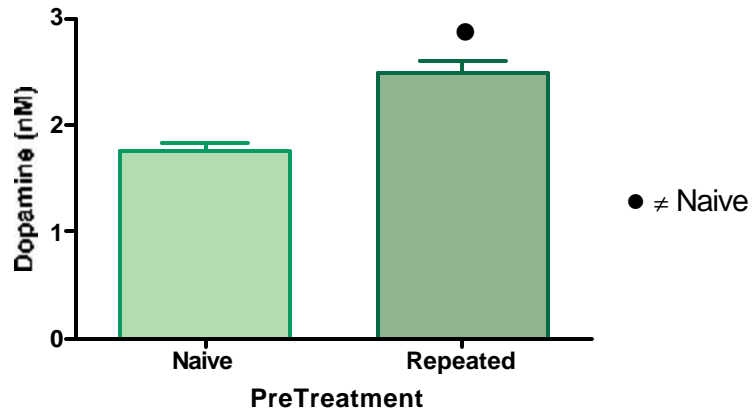

**Figure Two:** PND 25 animals exhibited significantly less basal DA in dialysate than PND 45 or PND 60. PND 45 animals demonstrated higher basal levels than all other ages examined (A). Animals pretreated with alcohol demonstrated higher basal levels than saline treated animals (B).

### Figure Three: Basal DOPAC/DA Levels in the NAcc

A.

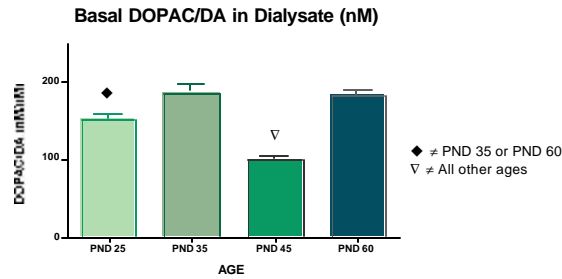

B.

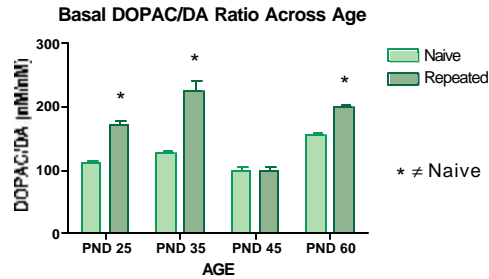

C.

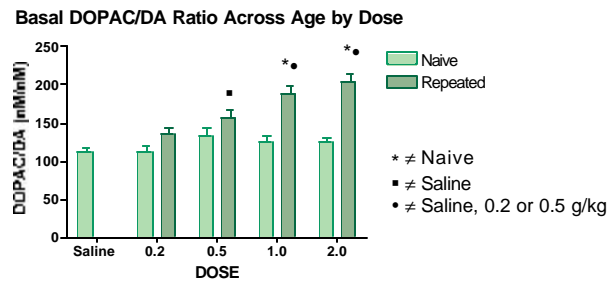

**Figure Three:** PND 45 animals had significantly lower DOPAC/DA ratios than all other ages, and PND 25 animals demonstrated lower ratios than PND 35 or PND 60 (A). In naïve animals, PND 60 animals demonstrated higher DOPAC/DA ratios than all other ages, and that PND 35 animals exhibited greater ratios than PND 45. With repeated exposure, PND 25 animals exhibit lower turnover values than PND 35 or PND 60, and PND 45 animals exhibited lower turnover than all ages. PND 45 animals did not show the elevation in turnover following repeated EtOH observed in all other ages (B). Repeated ethanol exposure shifted turnover rates. 0.5, 1.0 and 2.0 g/kg produced significant increases in DOPAC/DA ratio over Saline. 1.0 and 2.0 g/kg elevated turnover over 0.2 and 0.5 g/kg (C).

Analysis of Simple effects in Naïve animals revealed that PND 60 animals demonstrated higher DOPAC/DA ratios than all other ages, and that PND 35 animals exhibited greater ratios than PND 45. However, with Repeated exposure, PND 25 animals exhibit lower turnover values than PND 35 or PND 60, and PND 45 animals exhibited lower turnover than all ages. PND 45 animals did not show an elevation in turnover following repeated EtOH which was observed in all other ages (Figure Three: B). Additionally, following Repeated ethanol exposure there was a shift in turnover rates with 0.5, 1.0 and 2.0 g/kg producing significant increases in DOPAC/ DA ratio over Saline, and 1.0 and 2.0 g/kg elevating turnover over 0.2 and 0.5 g/kg as well (Figure Three: C).

Figure Four

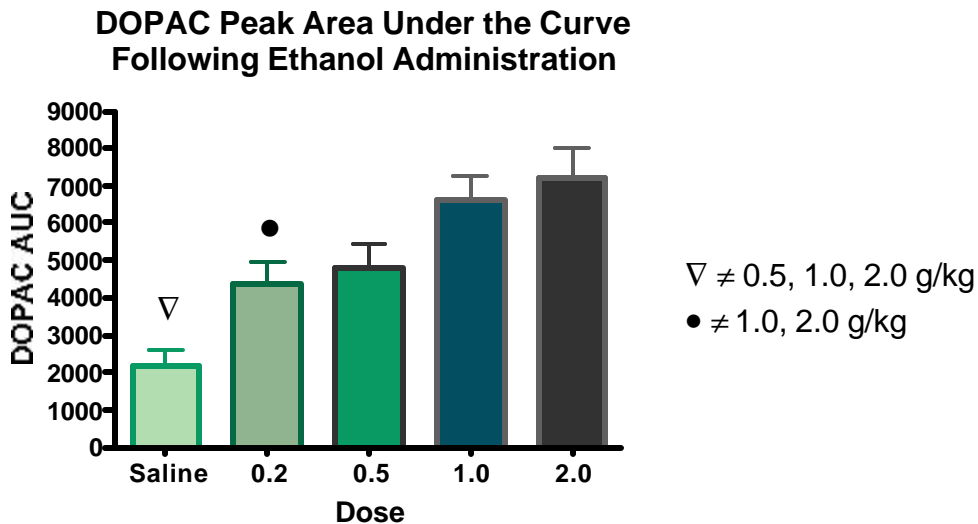

**Figure Four:** Saline was significantly different from 0.5, 1.0 and 2.0 g/kg i.p., while 0.2 and 0.5 g/kg were significantly different from 1.0 and 2.0 g/kg i.p.

Treatment Effects  
*DOPAC*

Peak DOPAC (%) AUC varied significantly as a function of Treatment,  $F(2, 265) = 14.989$ ,  $p < 0.05$  and Dose,  $F(3, 265) = 8.770$ ,  $p < 0.05$  and exhibited an Age X Treatment,  $F(6, 265) = 2.947$ ,  $p < 0.05$  interaction.

Subsequent Fisher's PLSD revealed that Saline was significantly different from 0.5, 1.0 and 2.0 g/kg i.p., while 0.2 and 0.5 g/kg were significantly different from 1.0 and 2.0 g/kg i.p. (Figure Four)

Analysis of simple effects revealed that for PND 25 animals, Saline, Repeated and Expectancy were significantly different from Acute while for PND 35 animals Saline and Expectancy significantly differed from Acute (Figure Five).

Figure Five

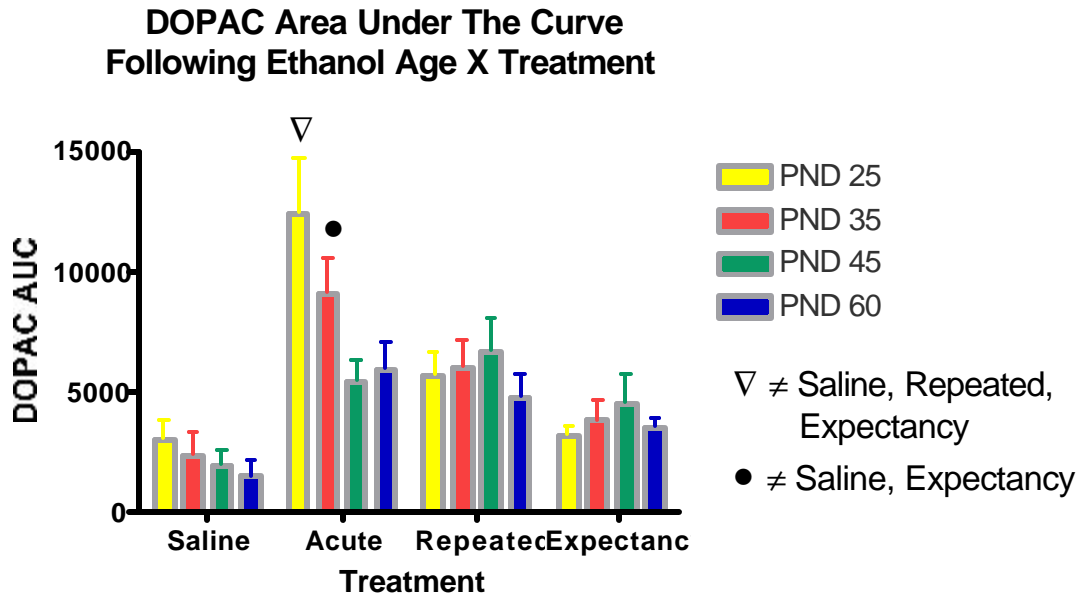

**Figure Five:** For PND 25 animals, Saline, Repeated and Expectancy differed from Acute. For PND 35 animals Saline and Expectancy differed from Acute.

#### *DA*

Peak DA (%) AUC varied significantly as a function of Treatment,  $F(2, 265) = 14.316$ ,  $p < 0.05$  and Dose,  $F(3, 265) = 5.963$ ,  $p < 0.05$  and exhibited an Treatment X Dose,  $F(6, 265) = 2.820$ ,  $p < 0.05$  interaction.

Analysis of simple effects revealed that for Acute treatment Saline and 0.2 g/kg were significantly different from 1.0 and 2.0 g/kg i.p. and 0.5 g/kg was significantly different from 2.0 g/kg i.p. For Repeated treatment 0.2 g/kg significantly differed from 1.0 and 2.0 g/kg i.p. Additionally, for 0.5 g/kg i.p. Saline differed significantly from Acute and Repeated, and Expectancy differed significantly from Acute. For 1.0 and 2.0 g/kg i.p. Saline differed significantly from Acute, Repeated and Expectancy, Expectancy differed significantly from Acute and Repeated and Repeated differed significantly from Acute (Figure Six).

#### *DOPAC/DA*

Peak DOPAC/DA (%) AUC exhibited a significant Age X Treatment  $F(6, 265) = 2.769$ ,  $p < 0.05$  interaction.

Analysis of simple effects revealed that for Acute treatment PND 25 animals were significantly different from PND 35, 45 and 60. Additionally, for PND 25 animals Saline and Acute differed significantly from Repeated and Expectancy treatments.

#### Temporal Effects

##### *DA*

##### **SALINE**

For PND 25 animals Area Under the Curve analysis revealed two peaks following Saline challenge, 10 (AUC = 304.1) and 90 (AUC = 276.7) minutes post injection. However, there were no significant elevations over baseline values for a given ten minute interval. For PND 35 animals Area Under the Curve analysis revealed no peaks

Figure Six

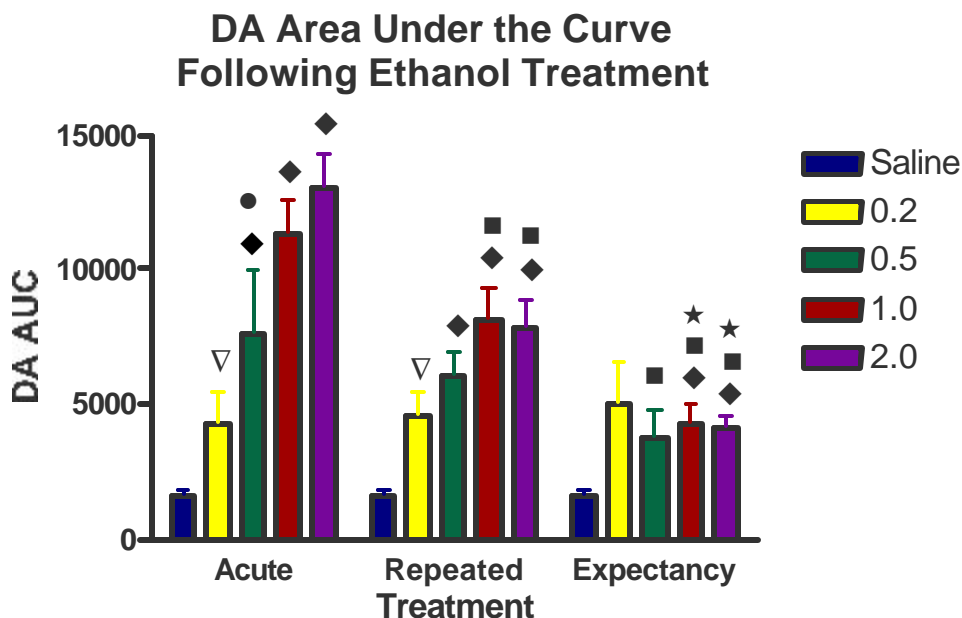

∇ ≠ 1.0, 2.0 g/kg    ● ≠ 2.0 g/kg    ◆ ≠ Saline    ■ ≠ Acute    ★ ≠ Repeated

**Figure Six:** For Acute treatment, Saline and 0.2 g/kg were significantly different from 1.0 and 2.0 g/kg i.p. and 0.5 g/kg was significantly different from 2.0 g/kg i.p. For Repeated treatment 0.2 g/kg significantly differed from 1.0 and 2.0 g/kg i.p. For 0.5 g/kg i.p. Saline differed significantly from Acute and Repeated, and Expectancy differed significantly from Acute. For 1.0 and 2.0 g/kg i.p. Saline differed significantly from Acute, Repeated and Expectancy. Expectancy differed significantly from Acute and Repeated and Repeated differed significantly from Acute.

following Saline challenge. For PND 45 animals Area Under the Curve analysis revealed one peak following Saline challenge, 80 (AUC = 428.7) minutes post injection. However, there were no significant elevations over baseline values for a given ten minute interval. For PND 60 animals Area Under the Curve analysis revealed two peaks following Saline challenge, 70 (AUC = 508.7) and 110 (AUC = 418.5) minutes post

injection. However, there were no significant elevations over baseline values for a given ten minute interval. No peaks differed significantly across age.

**ACUTE (Figure Seven A-D)**  
**0.2 G/KG ETOH**

For PND 25 animals Area Under the Curve analysis revealed one peak following 0.2 g/kg EtOH challenge, 40 (AUC = 1490) minutes post injection. However, there were no significant elevations over baseline values for a given ten minute interval. For PND 35 animals Area Under the Curve analysis revealed one peak following 0.2 g/kg EtOH challenge, 70 (AUC = 3157) minutes post injection. However, there were no significant elevations over baseline values for a given ten minute interval. For PND 45 animals Area Under the Curve analysis revealed one peak following 0.2 g/kg EtOH challenge, 80 (AUC = 4597) minutes post injection. This value was significantly elevated over Baseline and over PND 25 animals at 80 minutes post-injection. For PND 60 animals Area Under the Curve analysis revealed one peak following 0.2 g/kg EtOH challenge, 80 (AUC = 4008) minutes post injection. This value was significantly elevated over PND 25 animals at 80 minutes post-injection but was not significantly different from baseline.

**0.5 G/KG ETOH**

For PND 25 animals Area Under the Curve analysis revealed one peak following 0.5 g/kg EtOH challenge, 40 (AUC = 7837) minutes post injection. Analysis for significance versus baseline (Dunnett's,) revealed a significant elevation 40 and 60 minutes post-injection. For PND 35 animals Area Under the Curve analysis revealed one peak following 0.5 g/kg EtOH challenge, 20 (AUC = 10384) minutes post injection. However, there were no significant elevations over baseline values for a given ten minute interval. For PND 45 animals Area Under the Curve analysis revealed one peak

following 0.5 g/kg EtOH challenge, 50 (AUC = 4290) minutes post injection. However, there were no significant elevations over baseline values for a given ten minute interval. For PND 60 animals Area Under the Curve analysis revealed one peak following 0.5 g/kg EtOH challenge, 60 (AUC = 4503) minutes post injection. Analysis for significance versus baseline (Dunnett's,) revealed a significant elevation 50 and 60 minutes post-injection.

### **1.0 G/KG ETOH**

For PND 25 animals Area Under the Curve analysis revealed one peak following 1.0 g/kg EtOH challenge, 50 (AUC = 10572) minutes post injection. Analysis for significance versus baseline (Dunnett's,) revealed a significant elevation 40 - 60 minutes post-injection. For PND 35 animals Area Under the Curve analysis revealed one peak following 1.0 g/kg EtOH challenge, 60 (AUC = 15288) minutes post injection. Analysis for significance versus baseline (Dunnett's,) revealed a significant elevation 50 – 70 minutes post-injection. For PND 45 animals Area Under the Curve analysis revealed one peak following 1.0 g/kg EtOH challenge, 40 (AUC = 11734) minutes post injection. However, there were no significant elevations over baseline values for a given ten minute interval. For PND 60 animals Area Under the Curve analysis revealed one peak following 1.0 g/kg EtOH challenge, 60 (AUC = 5539) minutes post injection. Analysis for significance versus baseline (Dunnett's,) revealed a significant elevation 60 minutes post-injection.



Figure Seven

## Effects of Acute EtOH

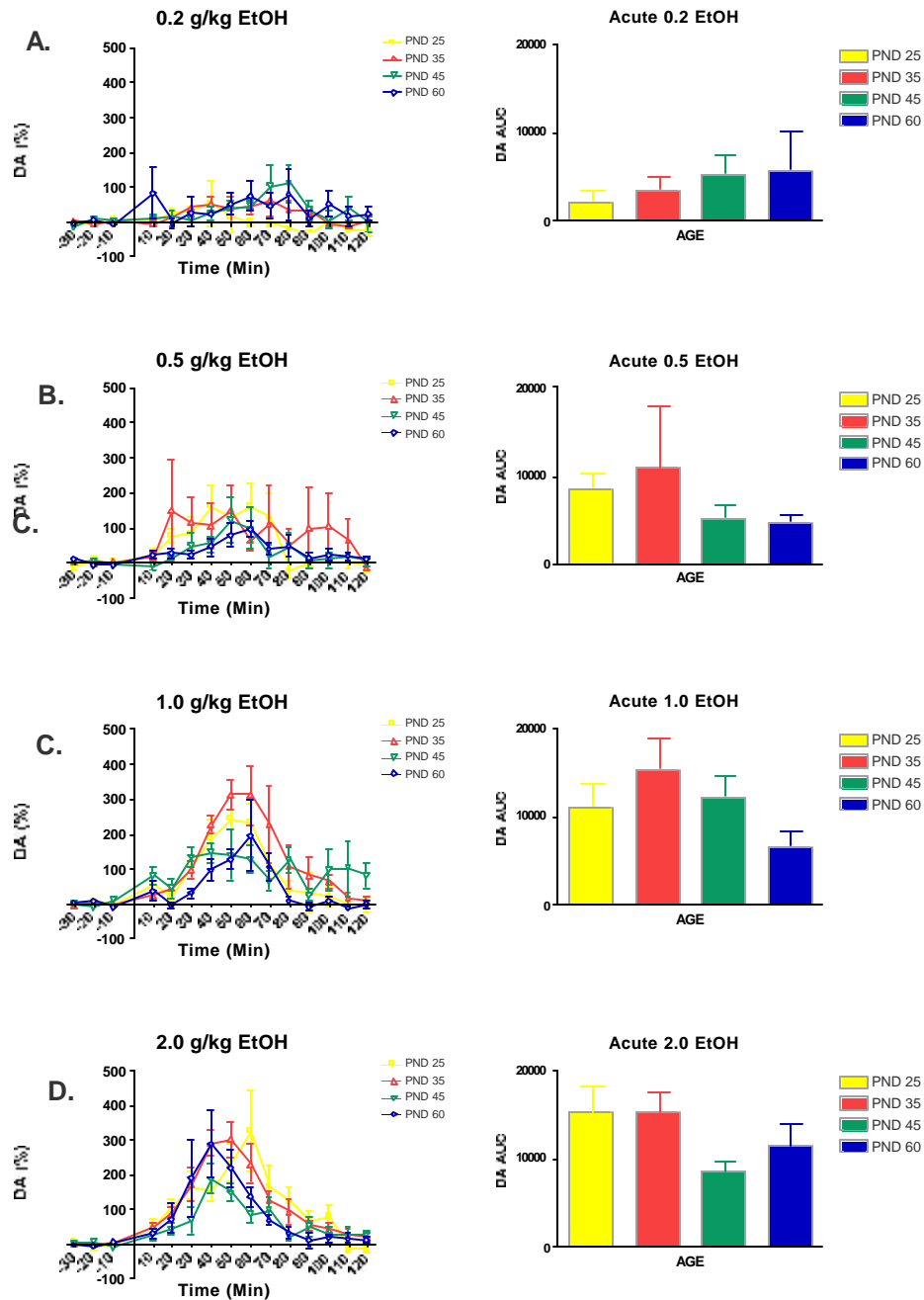

**Figure Seven:** Acute EtOH administration elevated NAcc DA levels in all ages in a dose dependent fashion. PND 45 animals were unique in demonstration peak elevations at 1.0 g/kg. All other ages demonstrated either peak elevations at 2.0 g/kg or, in the case of PND 35 animals, a plateau at 1.0 and 2.0 g/kg. Temporally, for all ages, DA elevations occurred between 30 and 70 minutes post injection.

### **2.0 G/KG ETOH**

For PND 25 animals Area Under the Curve analysis revealed one peak following 2.0 g/kg EtOH challenge, 60 (AUC = 14969) minutes post injection. Analysis for significance versus baseline (Dunnett's,) revealed a significant elevation 50 and 60 minutes post-injection. For PND 35 animals Area Under the Curve analysis revealed one peak following 2.0 g/kg EtOH challenge, 50 (AUC = 15097) minutes post injection. Analysis for significance versus baseline (Dunnett's,) revealed a significant elevation 30 - 70 minutes post-injection. For PND 45 animals Area Under the Curve analysis revealed one peak following 2.0 g/kg EtOH challenge, 40 (AUC = 8060) minutes post injection. Analysis for significance versus baseline (Dunnett's,) revealed a significant elevation 40 - 50 minutes post-injection. For PND 60 animals Area Under the Curve analysis revealed one peak following 2.0 g/kg EtOH challenge, 40 (AUC = 11122) minutes post injection. Analysis for significance versus baseline (Dunnett's,) revealed a significant elevation 40 - 50 minutes post-injection.

### **REPEATED (Figure Eight A-D)**

#### **0.2 G/KG ETOH**

For PND 25 animals Area Under the Curve analysis revealed one peak following 0.2 g/kg EtOH challenge, 20 (AUC = 4132) minutes post injection. However, there were no significant elevations over baseline values for a given ten minute interval. For PND 35 animals Area Under the Curve analysis revealed one peak following 0.2 g/kg EtOH challenge, 20 (AUC = 4133) minutes post injection. However, there were no significant elevations over baseline values for a given ten minute interval. For PND 45 animals Area Under the Curve analysis revealed one peak following 0.2 g/kg EtOH challenge, 20

(AUC = 4199) minutes post injection. However, there were no significant elevations over baseline values for a given ten minute interval. For PND 60 animals Area Under the Curve analysis revealed one peak following 0.2 g/kg EtOH challenge, 40 (AUC = 2730) minutes post injection. However, there were no significant elevations over baseline values for a given ten minute interval.

#### **0.5 G.KG ETOH**

For PND 25 animals Area Under the Curve analysis revealed one peak following 0.5 g/kg EtOH challenge, 30 (AUC = 5553) minutes post injection. Analysis for significance versus baseline (Dunnett's,) revealed a significant elevation 20 - 40 minutes post-injection. For PND 35 animals Area Under the Curve analysis revealed one peak following 0.5 g/kg EtOH challenge, 50 (AUC = 8274) minutes post injection. However, there were no significant elevations over baseline values for a given ten minute interval. For PND 45 animals Area Under the Curve analysis revealed one peak following 0.5 g/kg EtOH challenge, 40 (AUC = 4474) minutes post injection. Analysis for significance versus baseline (Dunnett's,) revealed a significant elevation 40 - 50 minutes post-injection. For PND 60 animals Area Under the Curve analysis revealed one peak following 0.5 g/kg EtOH challenge, 40 (AUC = 3742) minutes post injection. However, there were no significant elevations over baseline values for a given ten minute interval.

#### **1.0 G/KG ETOH**

For PND 25 animals Area Under the Curve analysis revealed one peak following 1.0 g/kg EtOH challenge, 40 (AUC = 7648) minutes post injection. Analysis for significance versus baseline (Dunnett's,) revealed a significant elevation 20 - 50 minutes post-injection. For PND 35 animals Area Under the Curve analysis revealed two peaks following 1.0 g/kg EtOH challenge, 40 (AUC = 7724) and 100 (AUC = 322.5) minutes

post injection. Analysis for significance versus baseline (Dunnett's,) revealed a significant elevation 30 - 40 minutes post-injection. For PND 45 animals Area Under the Curve analysis revealed one peak following 1.0 g/kg EtOH challenge, 40 (AUC = 8135) minutes post injection. Analysis for significance versus baseline (Dunnett's,) revealed a significant elevation 40 minutes post-injection. For PND 60 animals Area Under the Curve analysis revealed one peak following 1.0 g/kg EtOH challenge, 80 (AUC = 5057) minutes post injection. However, there were no significant elevations over baseline values for a given ten minute interval.

### **2.0 G/KG ETOH**

For PND 25 animals Area Under the Curve analysis revealed one peak following 2.0 g/kg EtOH challenge, 30 (AUC = 6764) minutes post injection. Analysis for significance versus baseline (Dunnett's,) revealed a significant elevation 30 - 40 minutes post-injection. For PND 35 animals Area Under the Curve analysis revealed one peak following 2.0 g/kg EtOH challenge, 30 (AUC = 8488) minutes post injection. Analysis for significance versus baseline (Dunnett's,) revealed a significant elevation 30 - 40 minutes post-injection. For PND 45 animals Area Under the Curve analysis revealed one peak following 2.0 g/kg EtOH challenge, 60 (AUC = 6921) minutes post injection. However, there were no significant elevations over baseline values for a given ten minute interval. For PND 60 animals Area Under the Curve analysis revealed one peak following 2.0 g/kg EtOH challenge, 60 (AUC = 7345) minutes post injection. However, there were no significant elevations over baseline values for a given ten minute interval.

Figure Eight

## Effects of Repeated EtOH

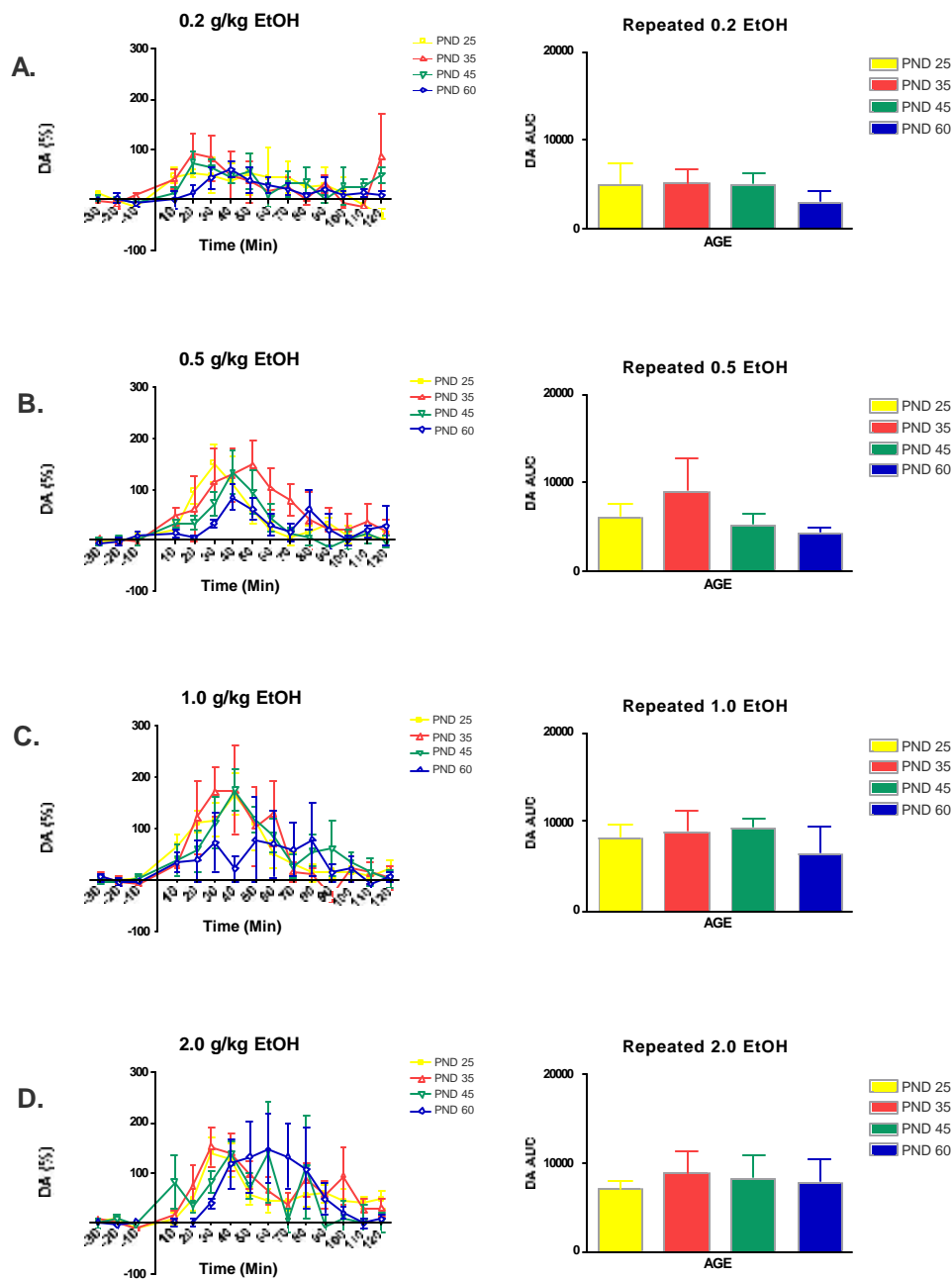

**Figure Eight:** Repeated EtOH administration elevated NAcc DA levels in all ages. For PND 25 and 35 animals, effects asymptote 0.5 g/kg. PND 45 animals reached plateau at 1.0 g/kg while PND 60 animals demonstrated a dose dependent increase. Temporally, effects occurred between 20 and 80 minutes post injection.

## EXPECTANCY (Figure Nine A-D)

### 0.2 G/KG ETOH

For PND 25 animals Area Under the Curve analysis revealed one peak following Saline challenge, 10 (AUC = 4849) minutes post injection. However, there were no significant elevations over baseline values for a given ten minute interval. For PND 35 animals Area Under the Curve analysis revealed three peaks following Saline challenge, 10 (AUC = 1269), 50 (AUC = 124.6) and 110 (AUC = 213.8) minutes post injection. However, there were no significant elevations over baseline values for a given ten minute interval. For PND 45 animals Area Under the Curve analysis revealed one peak following Saline challenge, 60 (AUC = 9317) minutes post injection. However, there were no significant elevations over baseline values for a given ten minute interval. For PND 60 animals Area Under the Curve analysis revealed one peak following Saline challenge, 80 (AUC = 2185) minutes post injection. However, there were no significant elevations over baseline values for a given ten minute interval.

### 0.5 G/KG ETOH

Area Under the Curve analysis revealed one peak following Saline challenge, 40 (AUC = 1198) minutes post injection. However, there were no significant elevations over baseline values for a given ten minute interval. For PND 35 animals Area Under the Curve analysis revealed three peaks following Saline challenge, 30 (AUC = 2413), 80 (AUC = 57.14) and 110 (AUC = 390.5) minutes post injection. Analysis for significance versus baseline (Dunnett's,) revealed a significant elevation 30 minutes post-injection. For PND 45 animals Area Under the Curve analysis revealed one peak following Saline challenge, 30 (AUC = 5043) minutes post injection. However, there were no significant elevations over baseline values for a given ten minute interval. For

PND 60 animals Area Under the Curve analysis revealed one peak following Saline challenge, 20 (AUC = 766.8) minutes post injection. However, there were no significant elevations over baseline values for a given ten minute interval.

#### **1.0 G/KG ETOH**

For PND 25 animals Area Under the Curve analysis revealed one peak following Saline challenge, 30 (AUC = 3019) minutes post injection. Analysis for significance versus baseline (Dunnett's,) revealed a significant elevation 30 minutes post-injection. For PND 35 animals Area Under the Curve analysis revealed two peaks following Saline challenge, 50 (AUC = 5431) and 110 (AUC = 967.7) minutes post injection. Analysis for significance versus baseline (Dunnett's,) revealed a significant elevation 50 minutes post-injection. For PND 45 animals Area Under the Curve analysis revealed one peak following Saline challenge, 40 (AUC = 2409) minutes post injection. Analysis for significance versus baseline (Dunnett's,) revealed a significant elevation 40 - 50 minutes post-injection. For PND 60 animals Area Under the Curve analysis revealed two peaks following Saline challenge, 40 (AUC = 2312) and 80 (AUC = 179.8) minutes post injection. Analysis for significance versus baseline (Dunnett's,) revealed a significant elevation 40 minutes post-injection.

#### **2.0 G/KG ETOH**

For PND 25 animals Area Under the Curve analysis revealed one peak following Saline challenge, 30 (AUC = 3039) minutes post injection. Analysis for significance versus baseline (Dunnett's,) revealed a significant elevation 30 minutes post-injection. For PND 35 animals Area Under the Curve analysis revealed one peak following Saline challenge, 40 (AUC = 2265) minutes post injection. However, there were no significant

Figure Nine

## Effects of Expected EtOH

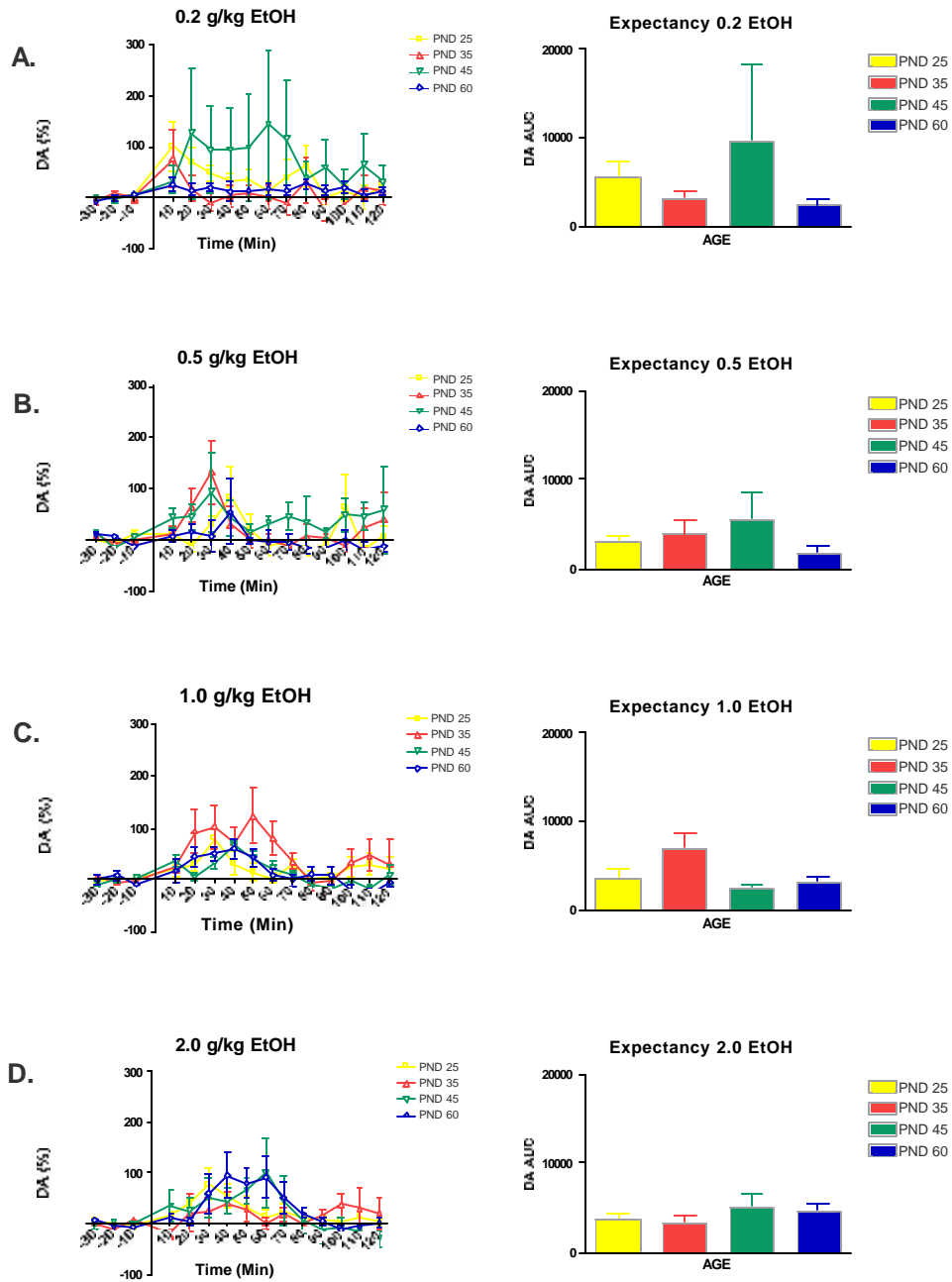

**Figure Nine :** All animals exhibited a Saline induced elevation in Nacc DA following EtOH pretreatment.



elevations over baseline values for a given ten minute interval. For PND 45 animals Area Under the Curve analysis revealed one peak following Saline challenge, 60 (AUC = 3920) minutes post injection. However, there were no significant elevations over baseline values for a given ten minute interval. For PND 60 animals Area Under the Curve analysis revealed one peak following Saline challenge, 40 (AUC = 4210) minutes post injection. Analysis for significance versus baseline (Dunnett's,) revealed a significant elevation 40 and 60 minutes post-injection.

### **Discussion**

The initiation of drug use and subsequent abuse liability is an issue of tremendous social significance in the adolescent population (SAMHSA 2003c, 2003a). Rates of drug use initiation are highest during the adolescent period and the risk of subsequent addiction is directly related to the age of use onset, with individuals initiating use prior to age 14 four times as likely to experience drug abuse or dependence related problems (Robins and Przybeck 1985; Anthony and Petronis 1995; DeWit et al. 2000). This relationship begs the question: do those predisposed to substance abuse and addiction initiate use earlier in life, *or* does the initiation of drug use earlier in life result in an increased propensity to drug addiction? While a few behavioral studies have attempted to address this in the human population, it is likely that if early drug use predisposes one to addiction, the biological mechanism for this process is drug induced alterations in the development of neural systems involved in motivated behavior.

A preponderance of evidence implicates the mesolimbic DA system as directly involved in a variety of basic motivational processes and appears to be key in the initiation and maintenance of drug administration behavior (Phillips et al. 1983; Hoebel

1985; Koob 1992a, 1992b; Koob et al. 1994; Koob 1996b, 1999; Leshner and Koob 1999; Koob 2000). Further, developmental studies have indicated that this system is undergoing substantial changes during the adolescent period (Seeman et al. 1987; Levy 1991; Teicher et al. 1993; Andersen and Gazzara 1994; Teicher et al. 1995; Coulter et al. 1996; Andersen et al. 1997; Anderson et al. 1997; Coulter et al. 1997; Teicher et al. 1998; Andersen and Teicher 1999; Seeman 1999a; Seeman 1999b; Andersen and Teicher 2000; Andersen et al. 2002). This relationship has lead investigators to suggest that some observed behavioral differences in adults and adolescents are mediated by alterations in the functionality of the DAergic system in the NAcc, as well as by the changing strength of various modulatory components within and innervating the NAcc (Spear 2000b; Chambers et al. 2003; Smith 2003). These developmental transitions mediate the observed impulsiveness and risk taking behaviors common to the adolescent period. As such, they are likely to mediate the initiation and maintenance of drug use, a set of behaviors that are clearly risky and often impulsive in nature (Zuckerman 1983, 1986, 1994).

The present results suggest that the mesolimbic projection to the NAcc septi is functionally different across adolescence. Basal DAergic tone differs across this period (Figure Two: A) and basal tone has previously been shown to be inversely related to phasic DAergic activity, suggesting that DAergic responsivity to stimuli may vary with age. These DAergic differences may be mediated in part by differences in metabolism as basal DOPAC levels also vary during the adolescent period (Figure One: A). These differences are most dramatically represented by transitional changes in DOPAC/DA ratio, indicative of changes in turnover processes across development (Figure Three: A).

In each case (DA, DOPAC or DOPAC/DA ratio) PND 45 animals (the equivalent of late adolescence) reveal themselves as neurochemically unique in NAcc responses. PND 45 animals exhibit elevated basal DA levels in the NAcc relative to all other ages while exhibiting lower DOPAC values than other adolescents or adults. These factors combine to produce an animal with very low turnover ratios relative to other ages (Figure Three: A), indicating a decreased ability at this age to effectively regulate extracellular DA concentrations. This increase in basal DAergic tone, in conjunction with the influence of tonic DA levels on phasic activity suggests that PND 45 animals may exhibit a decrease in DAergic responsivity to DAergic agonists relative to other ages. Alternatively, reduced turnover rates may indicate an inability to effectively metabolize DA that would result in elevated NAcc DA in response to an appropriate stimulus.

All ages exhibited a change in basal DA and metabolites with repeated ethanol exposure. Basal DOPAC levels increased in a dose dependent fashion (Figure One: B) while all doses of EtOH appeared to produce elevated basal DA levels (Figure Two: B). Consequently, DOPAC/DA ratios also increased in a dose dependent fashion (Figure Three: C) a tiered effect carried by the dose dependent influence of repeated EtOH on NAcc DOPAC concentrations. Interestingly, when examined in ratio form (DOPAC/DA) PND 45 animals were again unique in their response to ethanol. While all other ages exhibited an increase in DOPAC/DA ratio with repeated ethanol, PND 45 animals exhibited no change in basal DOPAC/DA turnover (Figure Three: B). This result suggests that, while in most ages repeated EtOH and subsequent potentiation of DA release results in an increased rate of DA metabolism, in PND 45 animals no compensatory change in DAergic metabolic rate exists to blunt the neurochemical effects

of repeated EtOH on NAcc DAergic projections. This failure to alter basal NAcc DAergic metabolism in response to repeated treatment suggests that PND 45 may be more susceptible to the incentive motivational properties of EtOH with multiple exposures. This outcome has been observed using an EtOH conditioned place preference paradigm (see Experiment Two).

For all ages, the administration of EtOH produced significant increases in NAcc DOPAC in a dose dependent fashion regardless of treatment regimen (Figure Four). Further, for PND 25 and 35 animals specifically, Acute EtOH elevated DOPAC levels to a greater degree than PND 45 and 60 animals (Figure Five). This increase is indicative of an increase in DA levels following EtOH injection and suggests that younger animals exhibit a greater acute response to EtOH, either through increased DA release or an acute increase in metabolism, than older animals.

For all ages, EtOH administration produced an elevation in DA concentration regardless of treatment regimen (Figure Six). Acute administration produced dose dependent increases in NAcc DA following EtOH challenge. Repeated treatment also produced dose dependent increases in NAcc DA, however the repeated administration of high doses (1.0 and 2.0 g/kg EtOH) blunted the DAergic response to EtOH challenge when compared to Acute doses of EtOH. Further, doses of 1.0 and 2.0 g/kg administered repeatedly resulted in significant elevations of NAcc DA in animals given a Saline challenge on test (Expectancy animals). These responses suggest, in general, that EtOH effectively elevates NAcc DA across ages, that repeated administration of high doses blunts acute responses to EtOH and that cues associated with high doses of EtOH can

effectively alter NAcc DA following repeated EtOH exposure in the same context. These results are critical for understanding the process of addiction in general.

Contemporary theory regarding the role of NAcc DA in the process of addiction (and in motivated behavior in general) is that enhanced DAergic activity in the NAcc facilitates the salience (perceptual significance) of stimuli, increasing the ability of secondary stimuli to acquire incentive motivational properties or to facilitate the inherent motivational capacity of primary reinforcers (Berridge and Robinson 1998; Di Chiara 1999; Di Chiara et al. 1999; Robinson and Berridge 2000; Berridge and Robinson 2003; McClure et al. 2003; Robinson and Berridge 2003). The present data indicates that repeated high doses of EtOH results in DAergic responses to cues indicative of EtOH administration, suggesting Pavlovian conditioning of a drug-induced neurochemical response. As such, according to incentive salience models, perception of secondary stimuli with associations to EtOH administration exhibit enhanced stimulus salience and therefore are more likely to influence behavior choices than stimuli lacking salience enhancing properties. In other words, the classically conditioned neurochemical response to drug related cues produces enhanced perceptual awareness of these cues relative to other information in the environment, biasing thoughts and subsequent behavior toward drug use.

Although, in general repeated ethanol exposure blunts subsequent responding to ethanol administration, late adolescent animals (PND 45) are unique in their pattern of response to ethanol administration at moderate doses (1.0 g/kg/i.p.). These animals exhibit a potentiated NAcc DA response on subsequent challenge, rather than a reduced response. According to the conditioned incentive-salience model discussed above, the

potentiation of NAcc DA release to repeated ethanol in late adolescent animals allows for the strengthening of contextual associations to a greater degree than in animals whose later ethanol exposures produce reduced responsivity. These successive Pavlovian pairings may imbue context and cues with greater motivational strength, promoting drug-related stimulus salience and creating associations with greater resistance to extinction or remodeling. This enhanced conditionability is evidenced in PND 45 animals using an ethanol CPP paradigm.

The present results clearly implicate ethanol exposure during adolescence as a critical risk factor in the development of alcohol abuse and addiction. Although not a necessary factor for later dependence, exposure to ethanol during adolescence does result in significant neurobiological changes in systems intimately involved in motivated behaviors. These changes do not influence addiction in a causal sense, but rather probabilistically. By enhancing the establishment and maintenance of drug-stimuli associations, the likelihood of drug related thoughts and behaviors becomes enhanced within the appropriate stimulus context. Further, each subsequent exposure within this context strengthens the association further and increases the ability of the environment to drive behavior choice. The behavioral patterns classified as addiction are revealed over successive experiences, as possibility shifts towards certainty and choice behavior comes primarily under stimulus control.

## References

- Andersen, S. L. and R. A. Gazzara (1994). The development of d2 autoreceptor-mediated modulation of k(+)-evoked dopamine release in the neostriatum. *Brain Res Dev Brain Res* **78**(1): 123-30.
- Andersen, S. L., M. Rutstein, J. M. Benzo, J. C. Hostetter and M. H. Teicher (1997). Sex differences in dopamine receptor overproduction and elimination. *Neuroreport* **8**(6): 1495-8.
- Andersen, S. L. and M. H. Teicher (1999). Cyclic adenosine monophosphate (camp) changes dramatically across periadolescence and region. *Society for Neuroscience Abstracts* **25**: 1471.
- Andersen, S. L. and M. H. Teicher (2000). Sex differences in dopamine receptors and their relevance to adhd. *Neurosci Biobehav Rev* **24**(1): 137-41.
- Andersen, S. L., A. P. Thompson, E. Krenzler and M. H. Teicher (2002). Pubertal changes in gonadal hormones do not underlie adolescent dopamine receptor overproduction. *Psychoneuroendocrinology* **27**(6): 683-91.
- Anderson, S. L., N. L. Dumont and M. H. Teicher (1997). Developmental differences in dopamine synthesis inhibition by (+/-)-7-oh-dpat. *Naunyn Schmiedebergs Arch Pharmacol* **356**(2): 173-81.
- Anlezark, G. M., G. W. Arbuthnott, J. E. Christie, T. J. Crow and P. J. Spear (1972). Electrical self-stimulation with brain stem electrodes. *J Physiol (Lond)* **227**(2): 6P-7P.
- Anlezark, G. M., G. W. Arbuthnott, J. E. Christie, T. J. Crow and P. J. Spear (1974). Electrical self-stimulation in relation to cells of origin of catecholamine-containing neural systems ascending from the brain stem. *J Physiol (Lond)* **237**(2): 31P-32P.
- Anthony, J. C. and K. R. Petronis (1995). Early-onset drug use and risk of later drug problems. *Drug Alcohol Depend* **40**(1): 9-15.
- Berridge, K. C. and T. E. Robinson (1998). What is the role of dopamine in reward: Hedonic impact, reward learning, or incentive salience? *Brain Res Brain Res Rev* **28**(3): 309-69.
- Berridge, K. C. and T. E. Robinson (2003). Parsing reward. *Trends Neurosci* **26**(9): 507-13.
- Chambers, R. A., J. R. Taylor and M. N. Potenza (2003). Developmental neurocircuitry of motivation in adolescence: A critical period of addiction vulnerability. *Am J Psychiatry* **160**(6): 1041-52.
- Coulter, C. L., H. K. Happe and L. C. Murrin (1996). Postnatal development of the dopamine transporter: A quantitative autoradiographic study [published erratum appears in *brain res dev brain res* 1996 jan 2;98(1):150]. *Brain Res Dev Brain Res* **92**(2): 172-81.

- Coulter, C. L., H. K. Happe and L. C. Murrin (1997). Dopamine transporter development in postnatal rat striatum: An autoradiographic study with [3h]win 35,428. *Brain Res Dev Brain Res* **104**(1-2): 55-62.
- Crow, T. J. (1971). The relation between electrical self-stimulation sites and catecholamine-containing neurons in the rat mesencephalon. *Experientia* **27**(6): 662.
- Crow, T. J. (1972). A map of the rat mesencephalon for electrical self-stimulation. *Brain Res* **36**(2): 265-73.
- Crow, T. J. (1973). Catecholamine-containing neurones and electrical self-stimulation. 2. A theoretical interpretation and some psychiatric implications. *Psychol Med* **3**(1): 66-73.
- Demotes-Mainard, J., C. Henry, Y. Jeantet, J. Arsaut and E. Arnould (1996). Postnatal ontogeny of dopamine d3 receptors in the mouse brain: Autoradiographic evidence for a transient cortical expression. *Brain Res Dev Brain Res* **94**(2): 166-74.
- DeWit, D. J., E. M. Adlaf, D. R. Offord and A. C. Ogborne (2000). Age at first alcohol use: A risk factor for the development of alcohol disorders. *Am J Psychiatry* **157**(5): 745-50.
- Di Chiara, G. (1999). Drug addiction as dopamine-dependent associative learning disorder. *Eur J Pharmacol* **375**(1-3): 13-30.
- Di Chiara, G., G. Tanda, V. Bassareo, F. Pontieri, E. Acquas, S. Fenu, C. Cadoni and E. Carboni (1999). Drug addiction as a disorder of associative learning. Role of nucleus accumbens shell/extended amygdala dopamine. *Ann N Y Acad Sci* **877**: 461-85.
- Hoebel, B. G. (1985). Brain neurotransmitters in food and drug reward. *Am J Clin Nutr* **42**(5 Suppl): 1133-50.
- Hoebel, B. G., A. P. Monaco, L. Hernandez, E. F. Aulisi, B. G. Stanley and L. Lenard (1983). Self-injection of amphetamine directly into the brain. *Psychopharmacology (Berl)* **81**(2): 158-63.
- Koob, G. F. (1992a). Drugs of abuse: Anatomy, pharmacology and function of reward pathways. *Trends Pharmacol Sci* **13**(5): 177-84.
- Koob, G. F. (1992b). Neural mechanisms of drug reinforcement. *Ann N Y Acad Sci* **654**: 171-91.
- Koob, G. F. (1992c). Neurobiological mechanisms in cocaine and opiate dependence. *Res Publ Assoc Res Nerv Ment Dis* **70**: 79-92.
- Koob, G. F. (1996a). Drug addiction: The yin and yang of hedonic homeostasis. *Neuron* **16**(5): 893-6.
- Koob, G. F. (1996b). Hedonic valence, dopamine and motivation. *Mol Psychiatry* **1**(3): 186-9.



- Koob, G. F. (1999). The role of the striatopallidal and extended amygdala systems in drug addiction. *Ann N Y Acad Sci* **877**: 445-60.
- Koob, G. F. (2000). Neurobiology of addiction. Toward the development of new therapies. *Ann N Y Acad Sci* **909**: 170-85.
- Koob, G. F., B. Caine, A. Markou, L. Pulvirenti and F. Weiss (1994). Role for the mesocortical dopamine system in the motivating effects of cocaine. *NIDA Res Monogr* **145**: 1-18.
- Leshner, A. I. and G. F. Koob (1999). Drugs of abuse and the brain. *Proc Assoc Am Physicians* **111**(2): 99-108.
- Levy, F. (1991). The dopamine theory of attention deficit hyperactivity disorder (adhd). *Aust N Z J Psychiatry* **25**(2): 277-83.
- McClure, S. M., N. D. Daw and P. R. Montague (2003). A computational substrate for incentive salience. *Trends Neurosci* **26**(8): 423-8.
- Moghaddam, B. and B. S. Bunney (1989). Differential effect of cocaine on extracellular dopamine levels in rat medial prefrontal cortex and nucleus accumbens: Comparison to amphetamine. *Synapse* **4**(2): 156-61.
- Odell, W. D. (1990). Sexual maturation in the rat. Control of onset of puberty. M. M. Grumbach, P. C. Sizonenko and M. L. Aubert. Baltimore, Williams and Wilkins: 183-210.
- Olds, M. E. and J. L. Fobes (1981). The central basis of motivation: Intracranial self-stimulation studies. *Annu Rev Psychol* **32**: 523-74.
- Phillips, A. G., C. L. Broekkamp and H. C. Fibiger (1983). Strategies for studying the neurochemical substrates of drug reinforcement in rodents. *Prog Neuropsychopharmacol Biol Psychiatry* **7**(4-6): 585-90.
- Phillips, T. J. and E. H. Shen (1996). Neurochemical bases of locomotion and ethanol stimulant effects. *Int Rev Neurobiol* **39**: 243-82.
- Philpot, R. M., S. McQuown and C. L. Kirstein (2001). Stereotaxic localization of the developing nucleus accumbens septi. *Brain Res Dev Brain Res* **130**(1): 149-53.
- Roberts, D. C. (1989). Breaking points on a progressive ratio schedule reinforced by intravenous apomorphine increase daily following 6-hydroxydopamine lesions of the nucleus accumbens. *Pharmacol Biochem Behav* **32**(1): 43-7.
- Robins, L. N. and T. R. Przybeck (1985). Age of onset of drug use as a factor in drug and other disorders. *NIDA Res Monogr* **56**: 178-92.
- Robinson, T. E. and K. C. Berridge (2000). The psychology and neurobiology of addiction: An incentive-sensitization view. *Addiction* **95 Suppl 2**: S91-117.
- Robinson, T. E. and K. C. Berridge (2003). Addiction. *Annu Rev Psychol* **54**: 25-53.
- SAMHSA (2003a). Alcohol use by persons under the legal drinking age of 21, Substance Abuse and Mental Health Services Administration.

- SAMHSA (2003b). Overview of findings from the 2002 national survey on drug use and health. Rockville, Office of Applied Studies.
- SAMHSA (2003c). Results from the 2002 national survey on drug use and health: National findings. Rockville, Substance Abuse and Mental Health Services Administration.
- Seeman, P. (1999a). Images in neuroscience. Brain development, x: Pruning during development. *Am J Psychiatry* **156**(2): 168.
- Seeman, P., N. H. Bzowej, H. C. Guan, C. Bergeron, L. E. Becker, G. P. Reynolds, E. D. Bird, P. Riederer, K. Jellinger, S. Watanabe and et al. (1987). Human brain dopamine receptors in children and aging adults. *Synapse* **1**(5): 399-404.
- Seeman, T. (1999b). Developmental influences across the life span. *Ann N Y Acad Sci* **896**: 64-5.
- Smith, R. F. (2003). Animal models of periadolescent substance abuse. *Neurotoxicol Teratol* **25**(3): 291-301.
- Spear, L. (2000a). Modeling adolescent development and alcohol use in animals. *Alcohol Res Health* **24**(2): 115-23.
- Spear, L. P. (2000b). The adolescent brain and age-related behavioral manifestations. *Neurosci Biobehav Rev* **24**(4): 417-63.
- Stanwood, G. D., S. McElligot, L. Lu and P. McGonigle (1997). Ontogeny of dopamine d3 receptors in the nucleus accumbens of the rat. *Neurosci Lett* **223**(1): 13-6.
- Stellar, J. R., A. E. Kelley and D. Corbett (1983). Effects of peripheral and central dopamine blockade on lateral hypothalamic self-stimulation: Evidence for both reward and motor deficits. *Pharmacol Biochem Behav* **18**(3): 433-42.
- Tarazi, F. I. and R. J. Baldessarini (2000). Comparative postnatal development of dopamine d(1), d(2) and d(4) receptors in rat forebrain. *Int J Dev Neurosci* **18**(1): 29-37.
- Teicher, M. H., S. L. Andersen and J. C. Hostetter, Jr. (1995). Evidence for dopamine receptor pruning between adolescence and adulthood in striatum but not nucleus accumbens. *Brain Res Dev Brain Res* **89**(2): 167-72.
- Teicher, M. H., N. I. Barber, H. A. Gelbard, A. L. Gallitano, A. Campbell, E. Marsh and R. J. Baldessarini (1993). Developmental differences in acute nigrostriatal and mesocorticolimbic system response to haloperidol. *Neuropsychopharmacology* **9**(2): 147-56.
- Teicher, M. H., N. L. Dumont and S. L. Andersen (1998). The developing prefrontal cortex: Is there a transient interneuron that stimulates catecholamine terminals? *Synapse* **29**(1): 89-91.
- Zito, K. A., G. Vickers and D. C. Roberts (1985). Disruption of cocaine and heroin self-administration following kainic acid lesions of the nucleus accumbens. *Pharmacol Biochem Behav* **23**(6): 1029-36.

- Zuckerman, M. (1974). The sensation seeking motive. *Prog Exp Pers Res* **7**: 79-148.
- Zuckerman, M. (1983). *Biological bases of sensation seeking, impulsivity, and anxiety*. Hillsdale, Erlbaum.
- Zuckerman, M. (1986). Sensation seeking and the endogenous deficit theory of drug abuse. *NIDA Res Monogr* **74**: 59-70.
- Zuckerman, M. (1994). *Behavioral expressions and biosocial bases of sensation seeking*. New York, Cambridge University Press.

## GENERAL DISCUSSION

The demonstration of reduced NP during adolescence, even an aversion to novelty in late adolescence, was an unanticipated outcome regarding the ontogeny of NP. Although under examined in rodent models, there are a few reports indicating that responsiveness to novel stimuli peaks during adolescence in mice and rats (Adriani et al. 1998; Spear 2000; Laviola et al. 2003). This is the anticipated profile in adolescents given more extensive reports of sensation seeking, risk-taking and harm avoidance in humans (Kandel 1982; Zuckerman 1994; Laviola et al. 1999; Spear 2000; Martin et al. 2002; Chambers et al. 2003; Crawford et al. 2003).

The lack of agreement of this study with previous reports in rodents and humans is likely a function of the paradigm utilized. The playground maze is a true measure of NP, while other procedures tend to measure behavioral sensitivity to novelty, usually in the form of changes in locomotor activity. Methods utilizing locomotor activity in the presence of novelty as a measure, fail to identify the hedonic aspects of the novel stimulus and are incorrectly identified as NP procedures and correlates to sensation seeking. In fact, increased behavioral activation in the presence of novelty has been considered a measure of anxiety in humans and an indicator of introversion or shyness (Bell et al. 1995). As such, it may be more suitable to characterize locomotion in the presence of novelty as sensation-responding rather than sensation-seeking.

It is not unreasonable to observe a positive relationship between novelty-induced activity and responsiveness to drugs of abuse. Given the DAergic commonality of the motor systems and the systems mediating drug motivation some relationship would be expected using activity as a dependent measure. Alternately, numerous studies link anxiety and perceived stress to an increased risk of substance abuse and addiction (Baer et al. 1987; Deykin et al. 1987; Johnson and Pandina 1993; Baer and Bray 1999; DeWit et al. 1999), therefore stress induced locomotion in the presence of novelty would also be anticipated to predict substance use effectively. Because the playground maze is a measure of NP, and the exploration of the unknown is inherently risky, this result is better characterized of as an indicator of curiosity, risk taking and harm avoidance. When considered in this frame the data presented here indicate a developmental reduction in these behaviors through the adolescent period. Because increasing habituation trials attenuates a novelty aversion in late adolescents and induces a NP in adults it is most reasonable to assume that the reduction in NP through adolescence represents a transitional increase in neophobia or harm avoidance, and not reduced curiosity or attraction to novelty. In essence, this developmental pattern supports the notion of the transition to contextual regulation of behavior that Spear (2000) suggested occurs during adolescence.

In adults ethanol induce CPP outcomes are consistent with the literature in rats (Stewart and Grupp 1986, 1989; Gauvin and Holloway 1992; Holloway et al. 1992; Schechter and Krimmer 1992). This consistency lends support to the interesting patterns observed in adolescence. Late adolescent animals exhibit an ethanol-induced CPP at doses of 0.5 and 1.0 g/kg i.p. indicating that late adolescent animals find the effects of

ethanol at moderate doses rewarding. In contrast, adults exhibit a progressive increase in avoidance of the ethanol paired environment while pre- and early adolescent animals do not demonstrate conditioning at 0.5 g/kg and exhibit a strong aversion at 1.0 g/kg. Prior data from our laboratory has shown that PND 25 animals exhibit significant increases in NAcc DA when given 1.0 g/kg of ethanol i.p. (Philpot and Kirstein 1998). Viewing dopaminergic activity in the NAcc as strictly mediating reward, these data would appear to be in conflict with the alcohol place aversion observed at this age. However, DAergic activity may be mediating reinforcement by way of increasing environmental salience of both appetitive and aversive stimuli. Viewing NAcc DA as mediating stimulus salience suggests that the magnitude, but not the direction, of drug conditioning is related to NAcc DA levels (for discussion see Appendices). Factors mediating the direction of the effect may be related to anxiety observed in the NP paradigm. Late adolescent animals were the only age to exhibit a novelty related aversion and it may be an underlying increase in anxiety that renders the sedative/anxiolytic effects of ethanol rewarding in this age. As previously mentioned there is a strong relationship between increased stress and increased risk of alcohol use in the adolescent specifically (Baer et al. 1987; Deykin et al. 1987; Johnson and Pandina 1993; Baer and Bray 1999; DeWit et al. 1999). Further, this is substantial evidence indicating elevated responsiveness to stressors during adolescence in both humans and rodents (for discussion see Spear, 2000). Therefore, it is possible that a developmental transition in sensitivity to stressors makes the late adolescent animal particularly vulnerable to the effects of ethanol.

The neurochemical data clearly indicate developmental differences in both the basal and ethanol mediated output of accumbal DA, a factor that may influence both the

age dependent sensitivity to ethanol induced place preference and the developmental transitions in response to novelty. Again late adolescent animals demonstrate a unique profile, exhibiting higher basal concentrations of DA and exhibiting resistance to turnover increases (DOPAC/DA) produced by repeated ethanol treatment in other ages. The ability of ethanol to induce a CPP in PND 45 animals may result from the large, sustained DA response across repeated exposures that is not observed in other ages. The continued elevated response across exposures allows for more effective conditioning, be it through sustained reward and/or enhanced salience as proposed in the attentional model (see Appendix). Enhanced stimulus salience, through elevated NAcc DA output may be at the heart of the observed NP profile. Although the neurochemical response to novelty was not tested, the pattern of basal DA levels in the NAcc is a near mirror image of the developmental pattern for NP. Given the relationship between drugs of abuse, sensation seeking and the mesolimbic DA system, this coincidence warrants further investigation.

### **Conclusions**

This project characterized the ontogenic profiles of ethanols' rewarding effects and underlying neurochemical actions as well as examined the transitional development of behaviors associated with addiction in the adolescent animal. These studies revealed: 1) developmental differences in behavioral responding to novel stimuli; 2) ontogenic differences in the rewarding efficacy of ethanol; 3) basal differences, as a function of development, in the tonic activity of DA in the NAcc; 4) differences in the DAergic response to acute ethanol administration across adolescence; 5) age dependent differences in the development of cellular tolerance to the DAergic effects of ethanol; and 6)

developmental differences in the ability of alcohol to establish neurochemical expectancies of drug, i.e. conditioned neurochemical responses to drug-associated cues.

The present project provides clear behavioral evidence for a distinct biological transition in novelty seeking through the adolescent period. The observed pattern, given the relationship between sensation seeking, NP and substance abuse liability in humans (Zuckerman 1986; McCourt et al. 1993) suggests a developmental transition in the rewarding efficacy of drugs of abuse. The ethanol CPP paradigm confirms that prediction, with PND 45 animals exhibiting a unique response profile clearly indicating that adolescence represents a unique risk period for alcohol addiction. The present project confirms observations made in the human population and further, because this is an animal model of addiction, suggests the distinct possibility that basic biological factors may be fundamental in the manifestation of adolescent alcohol use and subsequent addiction.

The results suggest the possibility that the biological transition that occurs during adolescence may manifest itself, in part, as increased preference for the appetitive aspects of alcohol. Given the substantial amount of data that suggests higher risk of alcoholism in those initiating alcohol use in adolescence (Hawkins et al. 1992; Hawkins et al. 1997; Grant and Dawson 1998; DeWit et al. 1999; DeWit et al. 2000; Guo et al. 2000); it is important to examine the mechanisms which underlie these behavioral tendencies. The present project demonstrates that reward mechanisms do not function identically in late adolescent and young adult animals and that exposure to ethanol during adolescence results in significant neurobiological changes in systems intimately involved in motivated behaviors. The attentional model of addiction (see Appendix) indicates that modified DA



activity contributes to addiction by enhancing the establishment and maintenance of drug-stimuli associations, increasing the likelihood of drug related thoughts and behaviors within the drug-associated context. Further, each subsequent exposure within these context strengthens the association further and increases the ability of the environment to drive behavior choice. The behavioral patterns classified as addiction are revealed over successive experiences, as possibility shifts towards certainty and choice behavior comes primarily under stimulus control. The functional neurochemistry of the developing adolescent leaves them particularly vulnerable to this process.

## LITERATURE CITED

- Adriani, W., F. Chiarotti and G. Laviola (1998). Elevated novelty seeking and peculiar d-amphetamine sensitization in periadolescent mice compared with adult mice. *Behav Neurosci* **112**(5): 1152-66.
- Andersen, S. L. and R. A. Gazzara (1994). The development of d2 autoreceptor-mediated modulation of k(+)-evoked dopamine release in the neostriatum. *Brain Res Dev Brain Res* **78**(1): 123-30.
- Andersen, S. L. and R. A. Gazzara (1996). Effects of (-)-sulpiride on dopamine release in striatum of developing rats: Degree of depolarization influences responsiveness. *J Neurochem* **67**(5): 1931-7.
- Andersen, S. L., M. Rutstein, J. M. Benzo, J. C. Hostetter and M. H. Teicher (1997). Sex differences in dopamine receptor overproduction and elimination. *Neuroreport* **8**(6): 1495-8.
- Andersen, S. L. and M. H. Teicher (1999). Cyclic adenosine monophosphate (camp) changes dramatically across periadolescence and region. *Society for Neuroscience Abstracts* **25**: 1471.
- Andersen, S. L. and M. H. Teicher (2000). Sex differences in dopamine receptors and their relevance to adhd. *Neurosci Biobehav Rev* **24**(1): 137-41.
- Andersen, S. L., A. P. Thompson, E. Krenzler and M. H. Teicher (2002). Pubertal changes in gonadal hormones do not underlie adolescent dopamine receptor overproduction. *Psychoneuroendocrinology* **27**(6): 683-91.
- Anderson, S. L., N. L. Dumont and M. H. Teicher (1997). Developmental differences in dopamine synthesis inhibition by (+/-)-7-oh-dpat. *Naunyn Schmiedebergs Arch Pharmacol* **356**(2): 173-81.
- Anlezark, G. M., G. W. Arbuthnott, J. E. Christie and T. J. Crow (1973). Proceedings: Electrical self-stimulation with electrodes in the region of the interpeduncular nucleus. *J Physiol* **234**(2): 103P-104P.
- Anlezark, G. M., G. W. Arbuthnott, J. E. Christie, T. J. Crow and P. J. Spear (1972). Electrical self-stimulation with brain stem electrodes. *J Physiol* **227**(2): 6P-7P.
- Anlezark, G. M., G. W. Arbuthnott, J. E. Christie, T. J. Crow and P. J. Spear (1974). Electrical self-stimulation in relation to cells of origin of catecholamine-containing neural systems ascending from the brain stem. *J Physiol* **237**(2): 31P-32P.

- Anlezark, G. M., D. S. Walter, G. W. Arbuthnott, T. J. Crow and D. Eccleston (1975). The relationship between noradrenaline turnover in cerebral cortex and electrical self-stimulation through electrodes in the region of locus coeruleus. *J Neurochem* **24**(4): 677-81.
- Anthony, J. C. and K. R. Petronis (1995). Early-onset drug use and risk of later drug problems. *Drug Alcohol Depend* **40**(1): 9-15.
- Arbuthnott, G. W., T. J. Crow, K. Fuxe, L. Olson and U. Ungerstedt (1970). Depletion of catecholamines in vivo induced by electrical stimulation of central monoamine pathways. *Brain Res* **24**(3): 471-83.
- Arnett, J. J. (1999). Adolescent storm and stress, reconsidered. *Am Psychol* **54**(5): 317-26.
- Asin, K. E., D. Wirtshafter and B. Tabakoff (1985). Failure to establish a conditioned place preference with ethanol in rats. *Pharmacol Biochem Behav* **22**(2): 169-73.
- Baer, P. E. and J. H. Bray (1999). Adolescent individuation and alcohol use. *J Stud Alcohol Suppl* **13**: 52-62.
- Baer, P. E., L. B. Garmezzy, R. J. McLaughlin, A. D. Pokorny and M. J. Wernick (1987). Stress, coping, family conflict, and adolescent alcohol use. *J Behav Med* **10**(5): 449-66.
- Bardo, M. T. and R. A. Bevins (2000). Conditioned place preference: What does it add to our preclinical understanding of drug reward? *Psychopharmacology (Berl)* **153**(1): 31-43.
- Bardo, M. T., R. L. Donohew and N. G. Harrington (1996). Psychobiology of novelty seeking and drug seeking behavior. *Behav Brain Res* **77**(1-2): 23-43.
- Bates, M. E., H. R. White and E. Labouvie (1994). Changes in sensation seeking needs and drug-use. *Drug use in america: Social, cultural, and political perspectives*. P. J. Venturelli. Sudbury, Jones & Bartlett.
- Bauer, R. and L. Evey (1981). Differential effects of amphetamine on ontogeny of active avoidance, intertrial responses, and locomotor activity. *Psychopharmacology* **75**(3): 299-304.
- Bell, I. R., E. E. Hardin, C. M. Baldwin and G. E. Schwartz (1995). Increased limbic system symptomatology and sensitizability of young adults with chemical and noise sensitivities. *Environ Res* **70**(2): 84-97.
- Bergman, J., B. K. Madras, S. E. Johnson and R. D. Spealman (1989). Effects of cocaine and related drugs in nonhuman primates. Iii. Self- administration by squirrel monkeys. *J Pharmacol Exp Ther* **251**(1): 150-5.
- Berridge, K. C. and T. E. Robinson (1998). What is the role of dopamine in reward: Hedonic impact, reward learning, or incentive salience? *Brain Res Brain Res Rev* **28**(3): 309-69.

- Berridge, K. C. and T. E. Robinson (2003). Parsing reward. *Trends Neurosci* **26**(9): 507-13.
- Bevins, R. A., J. E. Klebaur and M. T. Bardo (1997). Individual differences in response to novelty, amphetamine-induced activity and drug discrimination in rats. *Behav Pharmacol* **8**(2-3): 113-23.
- Bienkowski, P., P. Kuca and W. Kostowski (1995). Conditioned place preference after prolonged pre-exposure to ethanol. *Pol J Pharmacol* **47**(2): 189-91.
- Blackburn, J. R., A. G. Phillips and H. C. Fibiger (1987). Dopamine and preparatory behavior: I. Effects of pimozide. *Behav Neurosci* **101**(3): 352-60.
- Bolanos, C. A., G. M. Garmsen, M. A. Clair and S. A. McDougall (1996). Effects of the kappa-opioid receptor agonist u-50,488 on morphine- induced place preference conditioning in the developing rat. *Eur J Pharmacol* **317**(1): 1-8.
- Bolanos, C. A., S. J. Glatt and D. Jackson (1998). Subsensitivity to dopaminergic drugs in periadolescent rats: A behavioral and neurochemical analysis. *Brain Res Dev Brain Res* **111**(1): 25-33.
- Bozarth, M. A. (1990). Evidence for the rewarding effects of ethanol using the conditioned place preference method. *Pharmacol Biochem Behav* **35**(2): 485-7.
- Bradberry, C. W., R. J. Gruen, C. W. Berridge and R. H. Roth (1991). Individual differences in behavioral measures: Correlations with nucleus accumbens dopamine measured by microdialysis. *Pharmacol Biochem Behav* **39**(4): 877-82.
- Breslau, N., N. Fenn and E. L. Peterson (1993). Early smoking initiation and nicotine dependence in a cohort of young adults. *Drug Alcohol Depend* **33**(2): 129-37.
- Bronstein, P. M. (1972). Repeated trials with the albino rat in the open field as a function of age and deprivation. *J Comp Physiol Psychol* **81**(1): 84-93.
- Caine, S. B., S. C. Heinrichs, V. L. Coffin and G. F. Koob (1995). Effects of the dopamine d-1 antagonist sch 23390 microinjected into the accumbens, amygdala or striatum on cocaine self-administration in the rat. *Brain Res* **692**(1-2): 47-56.
- Califano, J. A. (2002). Teen tipplers: America's underage drinking problem. New York, The National Center on Addiction and Substance Abuse at Columbia University.
- Campbell, J. O., R. D. Wood and L. P. Spear (2000). Cocaine and morphine-induced place conditioning in adolescent and adult rats. *Physiol Behav* **68**(4): 487-93.
- Carelli, R. M., S. G. Ijames and A. J. Crumling (2000). Evidence that separate neural circuits in the nucleus accumbens encode cocaine versus "natural" (water and food) reward. *J Neurosci* **20**(11): 4255-66.
- Carr, G. D., H. C. Fibiger and A. G. Philips (1989). Conditioned place preference as a measure of drug reward. *The neuropharmacological basis of reward*. J. M. Liebman and S. J. Cooper. Oxford, Oxford University Press: 264-319.

- Chambers, R. A., J. R. Taylor and M. N. Potenza (2003). Developmental neurocircuitry of motivation in adolescence: A critical period of addiction vulnerability. *Am J Psychiatry* **160**(6): 1041-52.
- Ciccocioppo, R., I. Panocka, R. Froidi, E. Quitadamo and M. Massi (1999). Ethanol induces conditioned place preference in genetically selected alcohol-preferring rats. *Psychopharmacology (Berl)* **141**(3): 235-41.
- Cirulli, F. and G. Laviola (2000). Paradoxical effects of d-amphetamine in infant and adolescent mice: Role of gender and environmental risk factors. *Neurosci Biobehav Rev* **24**(1): 73-84.
- Colombo, G., A. Kuzmin, F. Fadda, L. Pani and G. L. Gessa (1990). Conditioned place preference induced by ethanol in a rat line selected for ethanol preference. *Pharmacol Res* **22 Suppl 3**: 48.
- Coulter, C. L., H. K. Happe and L. C. Murrin (1996a). Postnatal development of the dopamine transporter: A quantitative autoradiographic study. *Brain Res Dev Brain Res* **92**(2): 172-81.
- Coulter, C. L., H. K. Happe and L. C. Murrin (1996b). Postnatal development of the dopamine transporter: A quantitative autoradiographic study [published erratum appears in *brain res dev brain res* 1996 jan 2;98(1):150]. *Brain Res Dev Brain Res* **92**(2): 172-81.
- Coulter, C. L., H. K. Happe and L. C. Murrin (1997). Dopamine transporter development in postnatal rat striatum: An autoradiographic study with [<sup>3</sup>H]win 35,428. *Brain Res Dev Brain Res* **104**(1-2): 55-62.
- Crawford, A. M., M. A. Pentz, C. P. Chou, C. Li and J. H. Dwyer (2003). Parallel developmental trajectories of sensation seeking and regular substance use in adolescents. *Psychol Addict Behav* **17**(3): 179-92.
- Crews, F. T., C. J. Braun, B. Hoplight, R. C. Switzer, 3rd and D. J. Knapp (2000). Binge ethanol consumption causes differential brain damage in young adolescent rats compared with adult rats. *Alcohol Clin Exp Res* **24**(11): 1712-23.
- Crow, T. J. (1971). The relation between electrical self-stimulation sites and catecholamine-containing neurons in the rat mesencephalon. *Experientia* **27**(6): 662.
- Crow, T. J. (1972a). Catecholamine-containing neurones and electrical self-stimulation. 1. A review of some data. *Psychol Med* **2**(4): 414-21.
- Crow, T. J. (1972b). A map of the rat mesencephalon for electrical self-stimulation. *Brain Res* **36**(2): 265-73.
- Crow, T. J. (1973). Catecholamine-containing neurones and electrical self-stimulation. 2. A theoretical interpretation and some psychiatric implications. *Psychol Med* **3**(1): 66-73.

- Cunningham, C. L., C. L. Hallett, D. R. Niehus, J. S. Hunter, L. Nouth and F. O. Risinger (1991). Assessment of ethanol's hedonic effects in mice selectively bred for sensitivity to ethanol-induced hypothermia. *Psychopharmacology* **105**(1): 84-92.
- Cunningham, C. L. and C. M. Henderson (2000). Ethanol-induced conditioned place aversion in mice. *Behav Pharmacol* **11**(7-8): 591-602.
- Cunningham, C. L., C. M. Henderson and N. M. Bormann (1998). Extinction of ethanol-induced conditioned place preference and conditioned place aversion: Effects of naloxone. *Psychopharmacology (Berl)* **139**(1-2): 62-70.
- Cunningham, C. L., J. S. Niehus and D. Noble (1993). Species difference in sensitivity to ethanol's hedonic effects. *Alcohol* **10**(2): 97-102.
- Dahlstrom, A. and K. Fuxe (1964). Localization of monoamines in the lower brain stem. *Experientia* **20**(7): 398-9.
- De Wit, M. L., B. G. Embree and D. De Wit (1999). Determinants of the risk and timing of alcohol and illicit drug use onset among natives and non-natives: Similarities and differences in family attachment processes. *Soc Biol* **46**(1-2): 100-21.
- Demotes-Mainard, J., C. Henry, Y. Jeantet, J. Arsaut and E. Arnould (1996). Postnatal ontogeny of dopamine d3 receptors in the mouse brain: Autoradiographic evidence for a transient cortical expression. *Brain Res Dev Brain Res* **94**(2): 166-74.
- DeWit, D. J., E. M. Adlaf, D. R. Offord and A. C. Ogborne (2000). Age at first alcohol use: A risk factor for the development of alcohol disorders. *Am J Psychiatry* **157**(5): 745-50.
- DeWit, D. J., K. MacDonald and D. R. Offord (1999). Childhood stress and symptoms of drug dependence in adolescence and early adulthood: Social phobia as a mediator. *Am J Orthopsychiatry* **69**(1): 61-72.
- Deykin, E. Y., J. C. Levy and V. Wells (1987). Adolescent depression, alcohol and drug abuse. *Am J Public Health* **77**(2): 178-82.
- Di Chiara, G. (1999). Drug addiction as dopamine-dependent associative learning disorder. *Eur J Pharmacol* **375**(1-3): 13-30.
- Di Chiara, G. and A. Imperato (1988). Drugs abused by humans preferentially increase synaptic dopamine concentrations in the mesolimbic system of freely moving rats. *Proc Natl Acad Sci U S A* **85**(14): 5274-8.
- Di Chiara, G., G. Tanda, V. Bassareo, F. Pontieri, E. Acquas, S. Fenu, C. Cadoni and E. Carboni (1999). Drug addiction as a disorder of associative learning. Role of nucleus accumbens shell/extended amygdala dopamine. *Ann N Y Acad Sci* **877**: 461-85.
- Engleman, E. A., W. J. McBride, A. A. Wilber, S. R. Shaikh, R. D. Eha, L. Lumeng, T. K. Li and J. M. Murphy (2000). Reverse microdialysis of a dopamine uptake inhibitor in the nucleus accumbens of alcohol-preferring rats: Effects on dialysate dopamine levels and ethanol intake. *Alcohol Clin Exp Res* **24**(6): 795-801.

- Fouriez, G., P. Hansson and R. A. Wise (1978). Neuroleptic-induced attenuation of brain stimulation reward in rats. *J Comp Physiol Psychol* **92**(4): 661-71.
- Franques, P., M. Auriacombe and J. Tignol (2000). [addiction and personality]. *Encephale* **26**(1): 68-78.
- Fuxe, K. (1965). Evidence for the existence of monoamine neurons in the central nervous system. Iv. Distribution of monoamine nerve terminals in the central nervous system. *Acta Physiol Scand* **64**: SUPPL 247:37+.
- Gallistel, C. R. and D. Karras (1984). Pimozide and amphetamine have opposing effects on the reward summation function. *Pharmacol Biochem Behav* **20**(1): 73-7.
- Gauvin, D. V., R. J. Briscoe, K. L. Goulden and F. A. Holloway (1994). Aversive attributes of ethanol can be attenuated by dyadic social interaction in the rat. *Alcohol* **11**(3): 247-51.
- Gauvin, D. V. and F. A. Holloway (1992). Historical factors in the development of etoh-conditioned place preference. *Alcohol* **9**(1): 1-7.
- Geary, N. and G. P. Smith (1985). Pimozide decreases the positive reinforcing effect of sham fed sucrose in the rat. *Pharmacol Biochem Behav* **22**(5): 787-90.
- Glautier, S. (2000). Cravings and drug use. *Addiction* **95**(7): 1107.
- Goldman, M. (2002). Expectancy and risk for alcoholism: The unfortunate exploitation of a fundamental characteristic of neurobehavioral adaptation. *Alcohol: Clin and Exp Res* **26**(5): 737-746.
- Grant, B. F. and D. A. Dawson (1998). Age of onset of drug use and its association with dsm-iv drug abuse and dependence: Results from the national longitudinal alcohol epidemiologic survey. *J Subst Abuse* **10**(2): 163-73.
- Gunnarsdottir, E. D., R. A. Pingitore, B. J. Spring, L. M. Konopka, J. W. Crayton, T. Milo and P. Shirazi (2000). Individual differences among cocaine users. *Addict Behav* **25**(5): 641-52.
- Guo, J., L. M. Collins, K. G. Hill and J. D. Hawkins (2000). Developmental pathways to alcohol abuse and dependence in young adulthood. *J Stud Alcohol* **61**(6): 799-808.
- Guyon, A., F. Assouly-Besse, G. Biala, A. J. Puech and M. H. Thiebot (1993). Potentiation by low doses of selected neuroleptics of food-induced conditioned place preference in rats. *Psychopharmacology (Berl)* **110**(4): 460-6.
- Hawkins, J. D., R. F. Catalano and J. Y. Miller (1992). Risk and protective factors for alcohol and other drug problems in adolescence and early adulthood: Implications for substance abuse prevention. *Psychol Bull* **112**(1): 64-105.
- Hawkins, J. D., J. W. Graham, E. Maguin, R. Abbott, K. G. Hill and R. F. Catalano (1997). Exploring the effects of age of alcohol use initiation and psychosocial risk factors on subsequent alcohol misuse. *J Stud Alcohol* **58**(3): 280-90.

- Hedner, T. and P. Lundborg (1985). Development of dopamine autoreceptors in the postnatal rat brain. *J Neural Transm* **62**(1-2): 53-63.
- Heffner, T. G., M. J. Zigmond and E. M. Stricker (1977). Effects of dopaminergic agonists and antagonists of feeding in intact and 6-hydroxydopamine-treated rats. *J Pharmacol Exp Ther* **201**(2): 386-99.
- Heinrichs, S. C., F. Menzaghi, G. Schulteis, G. F. Koob and L. Stinus (1995). Suppression of corticotropin-releasing factor in the amygdala attenuates aversive consequences of morphine withdrawal. *Behav Pharmacol* **6**(1): 74-80.
- Hernandez, L. and B. G. Hoebel (1988). Food reward and cocaine increase extracellular dopamine in the nucleus accumbens as measured by microdialysis. *Life Sci* **42**(18): 1705-12.
- Hoebel, B. G. (1985). Brain neurotransmitters in food and drug reward. *Am J Clin Nutr* **42**(5 Suppl): 1133-50.
- Hoebel, B. G., A. P. Monaco, L. Hernandez, E. F. Aulisi, B. G. Stanley and L. Lenard (1983). Self-injection of amphetamine directly into the brain. *Psychopharmacology (Berl)* **81**(2): 158-63.
- Holloway, F. A., D. A. King, J. B. Bedingfield and D. V. Gauvin (1992). Role of context in ethanol tolerance and subsequent hedonic effects. *Alcohol* **9**(2): 109-16.
- Hooks, M. S. and P. W. Kalivas (1995). The role of mesoaccumbens--pallidal circuitry in novelty-induced behavioral activation. *Neuroscience* **64**(3): 587-97.
- Hsiao, S. and B. H. Chen (1995). Complex response competition and dopamine blocking: Choosing of high cost sucrose solution versus low cost water in rats. *Chin J Physiol* **38**(2): 99-109.
- Hsiao, S. and G. P. Smith (1995). Raclopride reduces sucrose preference in rats. *Pharmacol Biochem Behav* **50**(1): 121-5.
- Hubner, C. B. and G. F. Koob (1990). The ventral pallidum plays a role in mediating cocaine and heroin self-administration in the rat. *Brain Res* **508**(1): 20-9.
- Hughes, A. M., B. J. Everitt and J. Herbert (1990). Comparative effects of preoptic area infusions of opioid peptides, lesions and castration on sexual behaviour in male rats: Studies of instrumental behaviour, conditioned place preference and partner preference. *Psychopharmacology (Berl)* **102**(2): 243-56.
- Infurna, R. N. and L. P. Spear (1979). Developmental changes in amphetamine-induced taste aversions. *Pharmacol Biochem Behav* **11**(1): 31-5.
- Jernigan, T. L., J. R. Hesselink, E. Sowell and P. A. Tallal (1991). Cerebral structure on magnetic resonance imaging in language- and learning-impaired children. *Arch Neurol* **48**(5): 539-45.
- Johanson, C. E. and C. R. Schuster (1975). A choice procedure for drug reinforcers: Cocaine and methylphenidate in the rhesus monkey. *J Pharmacol Exp Ther* **193**(2): 676-88.



- Johnson, V. and R. J. Pandina (1993). A longitudinal examination of the relationships among stress, coping strategies, and problems associated with alcohol use. *Alcohol Clin Exp Res* **17**(3): 696-702.
- Johnston, L. D., P. M. O'Malley and J. G. Bachman (2002). Monitoring the future national results on adolescent drug use: Overview of key findings, 2001. Bethesda, MD, National Institute on Drug Abuse: NIH Publication No. 02-5105.
- Kandel, D. B. (1980). Drug use by youth: An overview. *NIDA Res Monogr* **38**: 1-24.
- Kandel, D. B. (1982). Epidemiological and psychosocial perspectives on adolescent drug use. *J Am Acad Child Psychiatry* **21**(4): 328-47.
- Kandel, D. B. and M. Davies (1992). Progression to regular marijuana involvement: Phenomenology and risk factors for nearly daily use. Vulnerability to drug abuse. M. Glantz and R. Pickens. Washington, American Psychological Association: 211-254.
- Kandel, D. B. and J. A. Logan (1984). Patterns of drug use from adolescence to young adulthood: I. Periods of risk for initiation, continued use, and discontinuation. *Am J Public Health* **74**(7): 660-6.
- Katner, S. N. and F. Weiss (2001). Neurochemical characteristics associated with ethanol preference in selected alcohol-preferring and -nonpreferring rats: A quantitative microdialysis study. *Alcohol Clin Exp Res* **25**(2): 198-205.
- Kelley, B. M., A. L. Bandy and L. D. Middaugh (1997). A study examining intravenous ethanol-conditioned place preference in c57bl/6j mice. *Alcohol Clin Exp Res* **21**(9): 1661-6.
- Kilpatrick, D. G., P. B. Sutker and A. D. Smith (1976). Deviant drug and alcohol use: The role of anxiety, sensation-seeking, and other personality variables. *Emotions and anxiety: New concepts, methods, and applications*. M. Zuckerman and C. D. Spielberger. Hillsdale, Erlbaum.
- Klebaur, J. E. and M. T. Bardo (1999). Individual differences in novelty seeking on the playground maze predict amphetamine conditioned place preference. *Pharmacol Biochem Behav* **63**(1): 131-6.
- Klebaur, J. E., R. A. Bevins, T. M. Segar and M. T. Bardo (2001). Individual differences in behavioral responses to novelty and amphetamine self-administration in male and female rats. *Behav Pharmacol* **12**(4): 267-75.
- Koob, G. F. (1992a). Drugs of abuse: Anatomy, pharmacology and function of reward pathways. *Trends Pharmacol Sci* **13**(5): 177-84.
- Koob, G. F. (1992). Neural mechanisms of drug reinforcement. *Ann N Y Acad Sci* **654**: 171-91.
- Koob, G. F. (1992c). Neurobiological mechanisms in cocaine and opiate dependence. *Res Publ Assoc Res Nerv Ment Dis* **70**: 79-92.

- Koob, G. F. (1996a). Drug addiction: The yin and yang of hedonic homeostasis. *Neuron* **16**(5): 893-6.
- Koob, G. F. (1996b). Hedonic valence, dopamine and motivation. *Mol Psychiatry* **1**(3): 186-9.
- Koob, G. F. (1999). The role of the striatopallidal and extended amygdala systems in drug addiction. *Ann N Y Acad Sci* **877**: 445-60.
- Koob, G. F. (2000). Neurobiology of addiction. Toward the development of new therapies. *Ann N Y Acad Sci* **909**: 170-85.
- Koob, G. F., B. Caine, A. Markou, L. Pulvirenti and F. Weiss (1994). Role for the mesocortical dopamine system in the motivating effects of cocaine. *NIDA Res Monogr* **145**: 1-18.
- Koob, G. F. and C. B. Hubner (1988). Reinforcement pathways for cocaine. *NIDA Res Monogr* **88**: 137-59.
- Koob, G. F. and E. J. Nestler (1997). The neurobiology of drug addiction. *J Neuropsychiatry Clin Neurosci* **9**(3): 482-97.
- Kuhar, M. J., M. C. Ritz and J. W. Boja (1991). The dopamine hypothesis of the reinforcing properties of cocaine. *Trends Neurosci* **14**(7): 299-302.
- Lanier, L. P. and R. L. Isaacson (1977). Early developmental changes in the locomotor response to amphetamine and their relation to hippocampal function. *Brain Res* **126**(3): 567-75.
- Laviola, G., W. Adriani, M. L. Terranova and G. Gerra (1999). Psychobiological risk factors for vulnerability to psychostimulants in human adolescents and animal models. *Neurosci Biobehav Rev* **23**(7): 993-1010.
- Laviola, G., G. Dell'Omo, E. Alleva and G. Bignami (1992). Ontogeny of cocaine hyperactivity and conditioned place preference in mice. *Psychopharmacology (Berl)* **107**(2-3): 221-8.
- Laviola, G., S. Macri, S. Morley-Fletcher and W. Adriani (2003). Risk-taking behavior in adolescent mice: Psychobiological determinants and early epigenetic influence. *Neurosci Biobehav Rev* **27**(1-2): 19-31.
- Le Moal, M. and H. Simon (1991). Mesocorticolimbic dopaminergic network: Functional and regulatory roles. *Physiol Rev* **71**(1): 155-234.
- Leshner, A. I. and G. F. Koob (1999). Drugs of abuse and the brain. *Proc Assoc Am Physicians* **111**(2): 99-108.
- Levy, F. (1991). The dopamine theory of attention deficit hyperactivity disorder (adhd). *Aust N Z J Psychiatry* **25**(2): 277-83.
- Lewis, D. A., S. R. Sesack, A. I. Levey and D. R. Rosenberg (1998). Dopamine axons in primate prefrontal cortex: Specificity of distribution, synaptic targets, and development. *Adv Pharmacol* **42**: 703-6.

- Martin, C. A., T. H. Kelly, M. K. Rayens, B. R. Brogli, A. Brenzel, W. J. Smith and H. A. Omar (2002). Sensation seeking, puberty, and nicotine, alcohol, and marijuana use in adolescence. *J Am Acad Child Adolesc Psychiatry* **41**(12): 1495-502.
- McBride, W. J., J. M. Murphy and S. Ikemoto (1999). Localization of brain reinforcement mechanisms: Intracranial self- administration and intracranial place-conditioning studies. *Behav Brain Res* **101**(2): 129-52.
- McClure, S. M., N. D. Daw and P. R. Montague (2003). A computational substrate for incentive salience. *Trends Neurosci* **26**(8): 423-8.
- McCourt, W. F., R. J. Gurrera and H. S. Cutter (1993). Sensation seeking and novelty seeking. Are they the same? *J Nerv Ment Dis* **181**(5): 309-12.
- Mehrara, B. J. and M. J. Baum (1990). Naloxone disrupts the expression but not the acquisition by male rats of a conditioned place preference response for an oestrous female. *Psychopharmacology (Berl)* **101**(1): 118-25.
- Miller, R. L. and M. J. Baum (1987). Naloxone inhibits mating and conditioned place preference for an estrous female in male rats soon after castration. *Pharmacol Biochem Behav* **26**(4): 781-9.
- Mogenson, G. J., D. L. Jones and C. Y. Yim (1980). From motivation to action: Functional interface between the limbic system and the motor system. *Prog Neurobiol* **14**(2-3): 69-97.
- Moghaddam, B. and B. S. Bunney (1989). Differential effect of cocaine on extracellular dopamine levels in rat medial prefrontal cortex and nucleus accumbens: Comparison to amphetamine. *Synapse* **4**(2): 156-61.
- Morse, A. C., G. Schulteis, F. A. Holloway and G. F. Koob (2000). Conditioned place aversion to the "hangover" phase of acute ethanol administration in the rat. *Alcohol* **22**(1): 19-24.
- Myers, M. G., S. A. Brown and M. A. Mott (1995). Preadolescent conduct disorder behaviors predict relapse and progression of addiction for adolescent alcohol and drug abusers. *Alcohol Clin Exp Res* **19**(6): 1528-36.
- Nicholls, B., A. Springham and J. Mellanby (1992). The playground maze: A new method for measuring directed exploration in the rat. *J Neurosci Methods* **43**(2-3): 171-80.
- Odell, W. D. (1990). Sexual maturation in the rat. Control of onset of puberty. M. M. Grumbach, P. C. Sizonenko and M. L. Aubert. Baltimore, Williams and Wilkins: 183-210.
- Ojeda, S. R. and H. F. Urbanski (1994). Puberty in the rat. The physiology of reproduction. E. Knobil and J. D. Neill. New York, Raven Press: 363-409.
- Olds, J. and P. Milner (1954). Positive reinforcement produced by electrical stimulation of septal area and other regions of rat brain. *J Comp Physiol Psychol* **47**(6): 419-27.

- Olds, M. E. and J. L. Fobes (1981). The central basis of motivation: Intracranial self-stimulation studies. *Annu Rev Psychol* **32**: 523-74.
- Papp, M. (1988). Different effects of short- and long-term treatment with imipramine on the apomorphine- and food-induced place preference conditioning in rats. *Pharmacol Biochem Behav* **30**(4): 889-93.
- Pedersen, W. (1991). Mental health, sensation seeking and drug use patterns: A longitudinal study. *Br J Addict* **86**(2): 195-204.
- Perks, S. M. and P. G. Clifton (1997). Reinforcer reevaluation and conditioned place preference. *Physiol Behav* **61**(1): 1-5.
- Phillips, A. G., C. L. Broekkamp and H. C. Fibiger (1983). Strategies for studying the neurochemical substrates of drug reinforcement in rodents. *Prog Neuropsychopharmacol Biol Psychiatry* **7**(4-6): 585-90.
- Phillips, A. G. and H. C. Fibiger (1978). The role of dopamine in maintaining intracranial self-stimulation in the ventral tegmentum, nucleus accumbens, and medial prefrontal cortex. *Can J Psychol* **32**(2): 58-66.
- Phillips, T. J. and E. H. Shen (1996). Neurochemical bases of locomotion and ethanol stimulant effects. *Int Rev Neurobiol* **39**: 243-82.
- Philpot, R. M. and C. L. Kirstein (1998). The effects of repeated alcohol exposure on the neurochemistry of the periadolescent nucleus accumbens septi. *Neuroreport* **9**(7): 1359-63.
- Philpot, R. M., S. McQuown and C. L. Kirstein (2001). Stereotaxic localization of the developing nucleus accumbens septi. *Brain Res Dev Brain Res* **130**(1): 149-53.
- Piazza, P. V., J. M. Deminiere, M. le Moal and H. Simon (1990). Stress- and pharmacologically-induced behavioral sensitization increases vulnerability to acquisition of amphetamine self-administration. *Brain Res* **514**(1): 22-6.
- Primus, R. J. and C. K. Kellogg (1989). Pubertal-related changes influence the development of environment-related social interaction in the male rat. *Dev Psychobiol* **22**(6): 633-43.
- Ranaldi, R. and R. J. Beninger (1994). The effects of systemic and intracerebral injections of d1 and d2 agonists on brain stimulation reward. *Brain Res* **651**(1-2): 283-92.
- Rebec, G. V., J. R. Christensen, C. Guerra and M. T. Bardo (1997). Regional and temporal differences in real-time dopamine efflux in the nucleus accumbens during free-choice novelty. *Brain Res* **776**(1-2): 61-7.
- Reid, L. D., G. A. Hunter, C. M. Beaman and C. L. Hubbell (1985). Toward understanding ethanol's capacity to be reinforcing: A conditioned place preference following injections of ethanol. *Pharmacol Biochem Behav* **22**(3): 483-7.

- Risinger, F. O., D. H. Malott, L. K. Prather, D. R. Niehus and C. L. Cunningham (1994). Motivational properties of ethanol in mice selectively bred for ethanol- induced locomotor differences. *Psychopharmacology (Berl)* **116**(2): 207-16.
- Roberts, D. C. (1989). Breaking points on a progressive ratio schedule reinforced by intravenous apomorphine increase daily following 6-hydroxydopamine lesions of the nucleus accumbens. *Pharmacol Biochem Behav* **32**(1): 43-7.
- Robins, L. N. and T. R. Przybeck (1985). Age of onset of drug use as a factor in drug and other disorders. *NIDA Res Monogr* **56**: 178-92.
- Robinson, T. E. and K. C. Berridge (2000). The psychology and neurobiology of addiction: An incentive-sensitization view. *Addiction* **95 Suppl 2**: S91-117.
- Robinson, T. E. and K. C. Berridge (2003). Addiction. *Annu Rev Psychol* **54**: 25-53.
- Rosenberg, D. R. and D. A. Lewis (1994). Changes in the dopaminergic innervation of monkey prefrontal cortex during late postnatal development: A tyrosine hydroxylase immunohistochemical study. *Biol Psychiatry* **36**(4): 272-7.
- Rosenberg, D. R. and D. A. Lewis (1995). Postnatal maturation of the dopaminergic innervation of monkey prefrontal and motor cortices: A tyrosine hydroxylase immunohistochemical analysis. *J Comp Neurol* **358**(3): 383-400.
- SAMHSA (2003a). Alcohol use by persons under the legal drinking age of 21, Substance Abuse and Mental Health Services Administration.
- SAMHSA (2003b). Overview of findings from the 2002 national survey on drug use and health. Rockville, Office of Applied Studies.
- SAMHSA (2003c). Results from the 2002 national survey on drug use and health: National findings. Rockville, Substance Abuse and Mental Health Services Administration.
- Schechter, M. D. (1992). Locomotor activity but not conditioned place preference is differentially affected by a moderate dose of ethanol administered to p and np rats. *Alcohol* **9**(3): 185-8.
- Schechter, M. D. and E. C. Krimmer (1992). Differences in response to the aversive properties and activity effects of low dose ethanol in las and has selectively bred rats. *Psychopharmacology (Berl)* **107**(4): 564-8.
- Schneider, L. H., J. Gibbs and G. P. Smith (1986). D2 selective receptor antagonists suppress sucrose sham feeding in the rat. *Brain Res Bull* **17**(4): 605-11.
- Schramm-Sapyta, N. L., A. R. Pratt and D. G. Winder (2004). Effects of periadolescent versus adult cocaine exposure on cocaine conditioned place preference and motor sensitization in mice. *Psychopharmacology (Berl)*.
- Seeman, P. (1999a). Images in neuroscience. Brain development, x: Pruning during development. *Am J Psychiatry* **156**(2): 168.

- Seeman, P., N. H. Bzowej, H. C. Guan, C. Bergeron, L. E. Becker, G. P. Reynolds, E. D. Bird, P. Riederer, K. Jellinger, S. Watanabe and et al. (1987). Human brain dopamine receptors in children and aging adults. *Synapse* **1**(5): 399-404.
- Seeman, T. (1999b). Developmental influences across the life span. *Ann N Y Acad Sci* **896**: 64-5.
- Sherman, J. E., C. Pickman, A. Rice, J. C. Liebeskind and E. W. Holman (1980). Rewarding and aversive effects of morphine: Temporal and pharmacological properties. *Pharmacol Biochem Behav* **13**(4): 501-5.
- Silveri, M. M. and L. P. Spear (1999). Ontogeny of rapid tolerance to the hypnotic effects of ethanol. *Alcohol Clin Exp Res* **23**(7): 1180-4.
- Silveri, M. M. and L. P. Spear (2000). Ontogeny of ethanol elimination and ethanol-induced hypothermia. *Alcohol* **20**(1): 45-53.
- Slawecki, C. J. (2002). Altered eeg responses to ethanol in adult rats exposed to ethanol during adolescence. *Alcohol Clin Exp Res* **26**(2): 246-54.
- Slawecki, C. J., M. Betancourt, M. Cole and C. L. Ehlers (2001). Periadolescent alcohol exposure has lasting effects on adult neurophysiological function in rats. *Brain Res Dev Brain Res* **128**(1): 63-72.
- Smith, G. P. and L. H. Schneider (1988). Relationships between mesolimbic dopamine function and eating behavior. *Ann N Y Acad Sci* **537**: 254-61.
- Smith, R. F. (2003). Animal models of periadolescent substance abuse. *Neurotoxicol Teratol* **25**(3): 291-301.
- Spear, L. (2000a). Modeling adolescent development and alcohol use in animals. *Alcohol Res Health* **24**(2): 115-23.
- Spear, L. P. (2000b). The adolescent brain and age-related behavioral manifestations. *Neurosci Biobehav Rev* **24**(4): 417-63.
- Spear, L. P. and S. C. Brake (1983). Periadolescence: Age-dependent behavior and psychopharmacological responsivity in rats. *Dev Psychobiol* **16**(2): 83-109.
- Spear, L. P. and J. Brick (1979). Cocaine-induced behavior in the developing rat. *Behav Neural Biol* **26**(4): 401-15.
- Spear, L. P., I. A. Shalaby and J. Brick (1980). Chronic administration of haloperidol during development: Behavioral and psychopharmacological effects. *Psychopharmacology* **70**(1): 47-58.
- Speciale, S. G., W. R. Crowley, T. L. O'Donohue and D. M. Jacobowitz (1978). Forebrain catecholamine projections of the a5 cell group. *Brain Res* **154**(1): 128-33.
- Spyraki, C., H. C. Fibiger and A. G. Phillips (1982a). Cocaine-induced place preference conditioning: Lack of effects of neuroleptics and 6-hydroxydopamine lesions. *Brain Res* **253**(1-2): 195-203.

- Spyraki, C., H. C. Fibiger and A. G. Phillips (1982b). Dopaminergic substrates of amphetamine-induced place preference conditioning. *Brain Res* **253**(1-2): 185-93.
- Stanwood, G. D., S. McElligot, L. Lu and P. McGonigle (1997a). Ontogeny of dopamine d3 receptors in the nucleus accumbens of the rat. *Neurosci Lett* **223**(1): 13-6.
- Stellar, J. R., A. E. Kelley and D. Corbett (1983). Effects of peripheral and central dopamine blockade on lateral hypothalamic self-stimulation: Evidence for both reward and motor deficits. *Pharmacol Biochem Behav* **18**(3): 433-42.
- Stewart, J. (1984). Reinstatement of heroin and cocaine self-administration behavior in the rat by intracerebral application of morphine in the ventral tegmental area. *Pharmacol Biochem Behav* **20**(6): 917-23.
- Stewart, R. B. and L. A. Grupp (1986). Conditioned place aversion mediated by orally self-administered ethanol in the rat. *Pharmacol Biochem Behav* **24**(5): 1369-75.
- Stewart, R. B. and L. A. Grupp (1989). Conditioned place aversion mediated by self-administered ethanol in the rat: A consideration of blood ethanol levels. *Pharmacol Biochem Behav* **32**(2): 431-7.
- Tam, T. W., C. Weisner and J. Mertens (2000). Demographic characteristics, life context, and patterns of substance use among alcohol-dependent treatment clients in a health maintenance organization. *Alcohol Clin Exp Res* **24**(12): 1803-10.
- Tarazi, F. I. and R. J. Baldessarini (2000). Comparative postnatal development of dopamine d(1), d(2) and d(4) receptors in rat forebrain. *Int J Dev Neurosci* **18**(1): 29-37.
- Teicher, M. H., S. L. Andersen and J. C. Hostetter, Jr. (1995). Evidence for dopamine receptor pruning between adolescence and adulthood in striatum but not nucleus accumbens. *Brain Res Dev Brain Res* **89**(2): 167-72.
- Teicher, M. H., N. I. Barber, H. A. Gelbard, A. L. Gallitano, A. Campbell, E. Marsh and R. J. Baldessarini (1993). Developmental differences in acute nigrostriatal and mesocorticolimbic system response to haloperidol. *Neuropsychopharmacology* **9**(2): 147-56.
- Teicher, M. H., N. L. Dumont and S. L. Andersen (1998). The developing prefrontal cortex: Is there a transient interneuron that stimulates catecholamine terminals? *Synapse* **29**(1): 89-91.
- Teichman, M., Z. Barnea and G. Rahav (1989). Sensation seeking, state and trait anxiety, and depressive mood in adolescent substance users. *Int J Addict* **24**(2): 87-99.
- Tirelli, E., G. Laviola and W. Adriani (2003). Ontogenesis of behavioral sensitization and conditioned place preference induced by psychostimulants in laboratory rodents. *Neurosci Biobehav Rev* **27**(1-2): 163-78.
- Tyrka, A. and G. P. Smith (1993). Sch23390, but not raclopride, decreases intake of intraorally infused 10% sucrose in adult rats. *Pharmacol Biochem Behav* **45**(1): 243-6.

- Tzschentke, T. M. (1998). Measuring reward with the conditioned place preference paradigm: A comprehensive review of drug effects, recent progress and new issues. *Prog Neurobiol* **56**(6): 613-72.
- Vastola, B. J., L. A. Douglas, E. I. Varlinskaya and L. P. Spear (2002). Nicotine-induced conditioned place preference in adolescent and adult rats. *Physiol Behav* **77**(1): 107-14.
- Virgili, M., O. Barnabei and A. Contestabile (1990). Regional maturation of neurotransmitter-related and glial markers during postnatal development in the rat. *Int J Dev Neurosci* **8**(2): 159-66.
- Weatherford, S. C., D. Greenberg, J. Gibbs and G. P. Smith (1990). The potency of d-1 and d-2 receptor antagonists is inversely related to the reward value of sham-fed corn oil and sucrose in rats. *Pharmacol Biochem Behav* **37**(2): 317-23.
- Weiss, F., R. Martin-Fardon, R. Ciccocioppo, T. M. Kerr, D. L. Smith and O. Ben-Shahar (2001). Enduring resistance to extinction of cocaine-seeking behavior induced by drug-related cues. *Neuropsychopharmacology* **25**(3): 361-72.
- White, A. M., A. J. Ghia, E. D. Levin and H. S. Swartzwelder (2000). Binge pattern ethanol exposure in adolescent and adult rats: Differential impact on subsequent responsiveness to ethanol. *Alcohol Clin Exp Res* **24**(8): 1251-6.
- White, F. J. (1996). Synaptic regulation of mesocorticolimbic dopamine neurons. *Annu Rev Neurosci* **19**: 405-36.
- White, T. L., A. J. Justice and H. de Wit (2002). Differential subjective effects of d-amphetamine by gender, hormone levels and menstrual cycle phase. *Pharmacol Biochem Behav* **73**(4): 729-41.
- Wise, R. A. (1978). Catecholamine theories of reward: A critical review. *Brain Res* **152**(2): 215-47.
- Wise, R. A. (1981). Intracranial self-stimulation: Mapping against the lateral boundaries of the dopaminergic cells of the substantia nigra. *Brain Res* **213**(1): 190-4.
- Wise, R. A., J. Spindler and L. Legault (1978). Major attenuation of food reward with performance-sparing doses of pimozide in the rat. *Can J Psychol* **32**(2): 77-85.
- Wise, R. A., R. A. Yokel and H. DeWit (1976). Both positive reinforcement and conditioned aversion from amphetamine and from apomorphine in rats. *Science* **191**(4233): 1273-5.
- Xenakis, S. and A. Sclafani (1981). The effects of pimozide on the consumption of a palatable saccharin-glucose solution in the rat. *Pharmacol Biochem Behav* **15**(3): 435-42.
- Yokel, R. A. and R. A. Wise (1975). Increased lever pressing for amphetamine after pimozide in rats: Implications for a dopamine theory of reward. *Science* **187**(4176): 547-9.



- York, J. L. and S. G. Regan (1982). Conditioned and unconditioned influences on body temperature and ethanol hypothermia in laboratory rats. *Pharmacol Biochem Behav* **17**(1): 119-24.
- Zigmond, M. J., T. G. Heffner and E. M. Stricker (1980). The effect of altered dopaminergic activity on food intake in the rat: Evidence for an optimal level of dopaminergic activity for behavior. *Prog Neuropsychopharmacol* **4**(4-5): 351-62.
- Zito, K. A., G. Vickers and D. C. Roberts (1985). Disruption of cocaine and heroin self-administration following kainic acid lesions of the nucleus accumbens. *Pharmacol Biochem Behav* **23**(6): 1029-36.
- Zuckerman, M. (1974). The sensation seeking motive. *Prog Exp Pers Res* **7**: 79-148.
- Zuckerman, M. (1979). *Sensation seeking: Beyond the optimal level of arousal*. Hillsdale, Erlbaum.
- Zuckerman, M. (1983). *Biological bases of sensation seeking, impulsivity, and anxiety*. Hillsdale, Erlbaum.
- Zuckerman, M. (1986). Sensation seeking and the endogenous deficit theory of drug abuse. *NIDA Res Monogr* **74**: 59-70.
- Zuckerman, M. (1994). *Behavioral expressions and biosocial bases of sensation seeking*. New York, Cambridge University Press.
- Zuckerman, M., J. C. Ballenger and R. M. Post (1984). The neurobiology of some dimensions of personality. *Int Rev Neurobiol* **25**: 391-436.
- Zuckerman, M. and M. Neeb (1979). Sensation seeking and psychopathology. *Psychiatry Res* **1**(3): 255-64.
- Zuckerman, M., H. Persky, K. E. Link and G. K. Basu (1968). Responses to confinement: An investigation of sensory deprivation, social isolation, restriction of movement and set factors. *Percept Mot Skills* **27**(1): 319-34.

# APPENDICES

**STEREOTAXIC LOCALIZATION OF THE DEVELOPING NUCLEUS  
ACCUMBENS SEPTI**

**Abstract**

The nucleus accumbens septi (NAcc) has been implicated as a mediator of a variety of disorders, most notably substance abuse. The development of this system is a critical area for investigation, and has been largely overlooked. Specifically, few studies have focussed on dopamine (DA), its neurochemical pathways and the long term consequences of manipulating the dopaminergic (DAergic) system in the developing animal. Important insight into the establishment of addiction, its development and time course, may be found by examining the development of the periadolescent DA system, specifically the mesocorticolimbic system. Recent developmental studies demonstrate dramatic changes in DAergic levels, receptor concentrations and transporter levels during periadolescent development. These ontogenetic changes, as well as drug exposure during development, may predispose the adolescent animal to addiction. Given that humans typically experiment with and initiate drug use during the adolescent period it is proposed that developmental alterations in the mesolimbic DA projection areas, specifically the NAcc, are an essential area for investigation in drug addiction. The present paper presents formulas for the weight-based calculation of stereotaxic coordinates for the NAcc in rats across development to facilitate further research in the area.

## Appendix A (Continued)

### **Introduction**

Recent studies have shown a unique profile for the development of the NAcc and its DAergic systems [3,5,6,10,12,33,35,38]. This profile of transformation suggests a potential for unique susceptibility of this transitional system to the effects of chronic or repeated exposure to DAergic agonists during adolescent development. Specifically, exposure to drugs of abuse, which almost universally act as DAergic agonists in the NAcc, can dramatically affect not only receptor and transporter systems but neurochemical profiles as well [25,26].

The NAcc has been strongly implicated as a critical brain region in the mediation of drug use and potentially drug addiction [16-18,22]. A variety of hypotheses have been presented as to how the structure specifically mediates the addictive process, however no clear-cut theory has been established. Regardless, a variety of converging lines of evidence point to this structure as being of primary importance in the establishment and/or maintenance of drug use [16-18,22]. Adolescence is a period of experimentation and risk-taking in both human and non-human animals, and drug use is often initiated during adolescence (for review see Spear, 2000)[31]. Given these findings it is important to investigate the nature of the relationship of drug use and abuse during the adolescent period and ongoing neurochemical activity in the NAcc.

Considering the importance of the NAcc in substance abuse, the ontogeny and/or events that occur during development of the NAcc demand attention, with particular focus on these ongoing processes through birth, preadolescence, periadolescence and into adulthood. Specifically defining these age periods is a complex issue that has recently been addressed and the periadolescent period of rats defined as approximately between

#### Appendix A (Continued)

the ages of postnatal days (PND) 21 and PND 50 [31]. Research conducted in young developing animals, during the periadolescent period, has examined the behavioral responsiveness of adolescent rats and mice to DA agonists [1,2,19,27,32], the developmental patterns of DA receptors [3,5,13,29,36] as well as DA transporters numbers [8,9] through adolescence (PND 21-50). Behavioral data indicate that adolescent rats show a reduced sensitivity to amphetamine and cocaine [7,21], an increased response to apomorphine [30], an increased sensitivity to haloperidol relative to younger and older animals [32] and an increased sensitivity to reward [20]. Neurochemically, basal DA synthesis in the NAcc is lower in postnatal day 30 (PND 30) than PND 40 rats and turnover rates for PND 30 animals are less than those reported in adult animals [6]. Research in our laboratory [25,26] has found that early adolescent rats (PND 25) have basal DA levels similar to those reported in adult animals [24]. Importantly, response profiles to alcohol [25] and cocaine [26] at this age are similar those observed in adult animals [11,14,23] as well. Our current research focuses on drug or drug expectancy-induced changes at later stages in adolescence and into adulthood, a time period that more closely parallels human abuse profiles. As mentioned previously, it is also a time period of numerous changes in the mesolimbic DA system. Research on DA receptor populations indicates a pattern of overproduction and pruning that occurs across adolescence in a sex-specific manner [3,5,36] with males exhibiting greater levels across age and greater over production of D1 and D2 receptor types. Similar patterns have been reported in humans as well [29]. In rats, the density of D1, D2, and D4 receptor populations in the NAcc increase and peak at PND 28, and then decline significantly to

#### Appendix A (Continued)

adult levels by PND 60 [34]. Furthermore, D3 receptor numbers appear to increase monotonically, with some reports finding adult levels at weaning (i.e., PND 21) [10] while others find D3 levels in weanlings far lower than those observed in adult animals [33]. In conjunction with receptor density changes, D1 stimulatory and D2 inhibitory effects on adenylyl cyclase production are less apparent in adolescence than in adult animals [4]. Parallel with these changes, DA transporter levels are increasing in concentration in the NAcc to adult levels through adolescence [8,9]. These data indicate that there is a distinct likelihood that the adolescent NAcc is unique in relation to adult and young animals. Therefore, it is necessary to examine this possibility extensively within the behaving organism.

The present study has established formulas for the accurate calculation of stereotaxic coordinates of the NAcc in the developing rat. These results allow for the application of a variety of *in vivo* neurochemical techniques to permit the quantification and evaluation of critical drug-related systems in alive, awake and freely moving adolescent animals. These neurochemical procedures (*in vivo* microdialysis, *in vivo* voltametry, *in vivo* chronoamperometry) would allow for a complementary analysis of ongoing neurochemical changes in the NAcc in response to drugs, drug-related stimuli, chronic drug exposure during development, stress and a variety of other interesting relationships. Information derived from using these techniques across age would determine transitional changes in DA and its effects in the NAcc. Additionally, examining these effects in conjunction with drug abuse during the periadolescent period

## Appendix A (Continued)

would provide critical insight into the mechanisms that underlie the establishment and maintenance of addiction.

### **Methods**

*Subjects:* Seventy-five Sprague Dawley (Zivic Miller Laboratories) rats of postnatal day (PND) 25, 35, 45 and 60 were used as subjects in this experiment. Pups were sexed and culled to 10 pups per litter on PND 1. On PND 21 pups were weaned and group housed until surgery. Animals were maintained in a temperature/humidity-controlled vivarium on a 12-hour light dark cycle.

*Intracranial Implantation:* Rats were anesthetized on either PND 25, 35, 45 or 60 using a xylazine/ketamine cocktail (0.15 and 1.0 mg/kg respectively). Rats were then placed in a stereotaxic frame. An incision was made over the skull and a hole drilled above the right hemisphere. A guide cannula was affixed with cyanoacrylate to the skull surface. A probe was lowered to the nucleus accumbens septi (NAcc) and cresyl violet (1  $\mu$ l) was injected to enhance the drop site. Following the procedure, animals were sacrificed with an anesthetic overdose of xylazine/ketamine cocktail. Brains were removed, frozen in methyl butane (-40° C), and sliced in 40  $\mu$ m sections for histological verification.

### **Results**

A total of 24 (6 @ PND 25, 7 @ PND 35, 5 @ PND 45 and 6 @ PND 60) surgeries were determined to be correctly positioned in the shell of the NAcc. Significant differences in weight were identified for SEX,  $F(1,67)=140.426$ ,  $p<0.05$ , AGE,  $F(3,67)=563.615$ ,  $p<0.05$  and SEX by AGE interaction,  $F(3,67)=22.552$ ,  $p<0.05$  with male exhibiting greater increases in weight across age (See Figure One). A regression

## Appendix A (Continued)

analysis of the effective dropsites across ages generated weight derived formulas for probe placement ( $x$  = the animals weight at the time of surgery;  $y$  = the distance in mm for the particular dimension). Weight explained 94% of the variability in location on the anterior-posterior axis (See Figure Two), 82% of the variability in location on the medial-lateral axis (See Figure Three) and 87% of the variability in location on the dorsal-ventral axis (See Figure Four). Using the average weights of each age/sex category the formulas yield the following effective coordinates at each age (See Table One).

### **Discussion**

The present study determined formulas for future investigations to target the NAcc in the developing rat. An interesting note for consideration given the present data involves the average weights determined across age and comparison to weights frequently reported in the literature for 'adult' animals. Numerous studies report using rats with weights ranging from 200-300g and these animals are considered adults within the framework of the study. Our analysis of age and weight, however, would indicate that although females weighing 250g are adult animals, male rats at similar weights are not adults but rather late adolescent animals with ages somewhere between 50 and 55 days (see Figure Two). Therefore, studies utilizing both male and female animals should exercise caution in using weights alone to establish chronological age.

The present data provide a foundation for potential studies of the ongoing neurochemical processes in the rat NAcc at different stages of adolescence. The examination of this structure during adolescence may provide critical insight into important issues including drug abuse. Specifically, systematic study of the accumbens



## Appendix A (Continued)

during development may help clarify the neurochemical processes involved in the establishment and maintenance of substance abuse.

Studies on the influence of repeated substance use during adolescence on the developing neurochemistry of the NAcc are ongoing in our laboratory. Specifically, focusing on the integration of opponent process and attentional/associative learning models of addiction within an adolescent framework. No other stimuli have been shown to elevate accumbal DA more effectively and reliably than drugs of abuse [15,28,37]. Given this fact, a critical question for developmental research and addiction is to determine the long-term effects of repeated administration of DA agonists on the developing adolescent DAergic system. Following such stimulation it is important to determine if the system will develop normally or if proper development is dependent upon the status and feedback of the internal milieu. If proper development of the DA system is dependent on a self-regulation process (i.e. receptor concentrations/sensitivity, transporter levels, enzyme activity and DA levels changes are symbiotic) substance use during this critical developmental period may lead to an alteration in basal DA activity in the adult. It is our hypothesis that the adolescent system is self-regulatory in its development and that chronic introduction of externally imposed elevations in DA (e.g., drugs of abuse) may lead to a basal hypoactive. Subsequently, the system may be stimulus hyperresponsive in adulthood, a result that may manifest itself behaviorally as anhedonia, sensation seeking and an increased likelihood of addiction. Future studies using these coordinates during this critical developmental period will provide insight into the unique mechanisms that may underlie the establishment of addiction in adolescence.

## Appendix A (Continued)

### References

- [1] Adriani, W., Chiarotti, F. and Laviola, G., Elevated novelty seeking and peculiar d-amphetamine sensitization in periadolescent mice compared with adult mice, *Behav Neurosci*, 112 (1998) 1152-66.
- [2] Adriani, W. and Laviola, G., A unique hormonal and behavioral hyporesponsivity to both forced novelty and d-amphetamine in periadolescent mice, *Neuropharmacology*, 39 (2000) 334-46.
- [3] Andersen, S.L., Rutstein, M., Benzo, J.M., Hostetter, J.C. and Teicher, M.H., Sex differences in dopamine receptor overproduction and elimination, *Neuroreport*, 8 (1997) 1495-8.
- [4] Andersen, S.L. and Teicher, M.H., Cyclic adenosine monophosphate (cAMP) changes dramatically across periadolescence and region, *Society for Neuroscience Abstracts*, 25 (1999) 1471.
- [5] Andersen, S.L. and Teicher, M.H., Sex differences in dopamine receptors and their relevance to ADHD, *Neurosci Biobehav Rev*, 24 (2000) 137-41.
- [6] Anderson, S.L., Dumont, N.L. and Teicher, M.H., Developmental differences in dopamine synthesis inhibition by (+/-)-7- OH-DPAT, *Naunyn Schmiedeberg's Arch Pharmacol*, 356 (1997) 173-81.
- [7] Bauer, R.H. and Duncan, D.L., Differential effects of D-amphetamine in mature and immature rats, *Physiological Psychology*, 3 (1975) 312-316.
- [8] Coulter, C.L., Happe, H.K. and Murrin, L.C., Postnatal development of the dopamine transporter: a quantitative autoradiographic study [published erratum appears in *Brain Res Dev Brain Res* 1996 Jan 2;98(1):150], *Brain Res Dev Brain Res*, 92 (1996) 172-81.
- [9] Coulter, C.L., Happe, H.K. and Murrin, L.C., Dopamine transporter development in postnatal rat striatum: an autoradiographic study with [3H]WIN 35,428, *Brain Res Dev Brain Res*, 104 (1997) 55-62.
- [10] Demotes-Mainard, J., Henry, C., Jeantet, Y., Arsaut, J. and Arnould, E., Postnatal ontogeny of dopamine D3 receptors in the mouse brain: autoradiographic evidence for a transient cortical expression, *Brain Res Dev Brain Res*, 94 (1996) 166-74.
- [11] Di Chiara, G. and Imperato, A., Drugs abused by humans preferentially increase synaptic dopamine concentrations in the mesolimbic system of freely moving rats, *Proc Natl Acad Sci U S A*, 85 (1988) 5274-8.
- [12] Gurevich, E.V., Himes, J.W. and Joyce, J.N., Developmental regulation of expression of the D3 dopamine receptor in rat nucleus accumbens and islands of Calleja, *J Pharmacol Exp Ther*, 289 (1999) 587-98.
- [13] Hartley, E.J. and Seeman, P., Development of receptors for dopamine and noradrenaline in rat brain, *Eur J Pharmacol*, 91 (1983) 391-7.

Appendix A (Continued)

- [14] Hoebel, B.G. and Hernandez, L., Microdialysis studies of psychostimulants, *NIDA Res Monogr*, 95 (1989) 343-4.
- [15] Joseph, M.H. and Hodges, H., Lever pressing for food reward and changes in dopamine turnover and uric acid in rat caudate and nucleus accumbens studied chronically by *in vivo* voltammetry, *J Neurosci Methods*, 34 (1990) 143-9.
- [16] Koob, G.F., Circuits, drugs, and drug addiction, *Adv Pharmacol*, 42 (1998) 978-82.
- [17] Koob, G.F., Drug abuse and alcoholism. Overview, *Adv Pharmacol*, 42 (1998) 969-77.
- [18] Koob, G.F., Sanna, P.P. and Bloom, F.E., Neuroscience of addiction, *Neuron*, 21 (1998) 467-76.
- [19] Laviola, G., Adriani, W., Terranova, M.L. and Gerra, G., Psychobiological risk factors for vulnerability to psychostimulants in human adolescents and animal models, *Neurosci Biobehav Rev*, 23 (1999) 993-1010.
- [20] Laviola, G., Dell'Omo, G., Alleva, E. and Bignami, G., Ontogeny of cocaine hyperactivity and conditioned place preference in mice, *Psychopharmacology*, 107 (1992) 221-8.
- [21] Laviola, G., Wood, R.D., Kuhn, C., Francis, R. and Spear, L.P., Cocaine sensitization in periadolescent and adult rats, *J Pharmacol Exp Ther*, 275 (1995) 345-57.
- [22] Leshner, A.I. and Koob, G.F., Drugs of abuse and the brain, *Proc Assoc Am Physicians*, 111 (1999) 99-108.
- [23] Nurmi, M., Ashizawa, T., Sinclair, J.D. and Kiianmaa, K., Effect of prior ethanol experience on dopamine overflow in accumbens of AA and ANA rats, *Eur J Pharmacol*, 315 (1996) 277-83.
- [24] Parsons, L.H. and Justice, J.B., Jr., Extracellular concentration and *in vivo* recovery of dopamine in the nucleus accumbens using microdialysis, *J Neurochem*, 58 (1992) 212-8.
- [25] Philpot, R.M. and Kirstein, C.L., The effects of repeated alcohol exposure on the neurochemistry of the periadolescent nucleus accumbens septi, *Neuroreport*, 9 (1998) 1359-63.
- [26] Philpot, R.M. and Kirstein, C.L., Repeated cocaine exposure: effects on catecholamines in the nucleus accumbens septi of periadolescent animals, *Pharmacol Biochem Behav*, 62 (1999) 465-72.
- [27] Reinstein, D.K., McClearn, D. and Isaacson, R.L., The development of responsiveness to dopaminergic agonists, *Brain Res*, 150 (1978) 216-23.
- [28] Salamone, J.D., Cousins, M.S. and Snyder, B.J., Behavioral functions of nucleus accumbens dopamine: empirical and conceptual problems with the anhedonia

Appendix A (Continued)

- hypothesis, *Neurosci Biobehav Rev*, 21 (1997) 341-59.
- [29] Seeman, P., Bzowej, N.H., Guan, H.C., Bergeron, C., Becker, L.E., Reynolds, G.P., Bird, E.D., Riederer, P., Jellinger, K., Watanabe, S. and et al., Human brain dopamine receptors in children and aging adults, *Synapse*, 1 (1987) 399-404.
- [30] Shalaby, I.A. and Spear, L.P., Psychopharmacological effects of low and high doses of apomorphine during ontogeny, *Eur J Pharmacol*, 67 (1980) 451-9.
- [31] Spear, L.P., The adolescent brain and age-related behavioral manifestations [In Process Citation], *Neurosci Biobehav Rev*, 24 (2000) 417-63.
- [32] Spear, L.P. and Brake, S.C., Periadolescence: age-dependent behavior and psychopharmacological responsivity in rats, *Dev Psychobiol*, 16 (1983) 83-109.
- [33] Stanwood, G.D., McElligot, S., Lu, L. and McGonigle, P., Ontogeny of dopamine D3 receptors in the nucleus accumbens of the rat, *Neurosci Lett*, 223 (1997) 13-6.
- [34] Tarazi, F.I. and Baldessarini, R.J., Comparative postnatal development of dopamine D(1), D(2) and D(4) receptors in rat forebrain, *Int J Dev Neurosci*, 18 (2000) 29-37.
- [35] Tarazi, F.I., Tomasini, E.C. and Baldessarini, R.J., Postnatal development of dopamine and serotonin transporters in rat caudate-putamen and nucleus accumbens septi, *Neurosci Lett*, 254 (1998) 21-4.
- [36] Teicher, M.H., Andersen, S.L. and Hostetter, J.C., Jr., Evidence for dopamine receptor pruning between adolescence and adulthood in striatum but not nucleus accumbens, *Brain Res Dev Brain Res*, 89 (1995) 167-72.
- [37] Tzschentke, T.M., Measuring reward with the conditioned place preference paradigm: a comprehensive review of drug effects, recent progress and new issues, *Prog Neurobiol*, 56 (1998) 613-72.
- [38] Wang, L. and Pitts, D.K., Postnatal development of mesoaccumbens dopamine neurons in the rat: electrophysiological studies, *Brain Res Dev Brain Res*, 79 (1994) 19-28.

Figure One

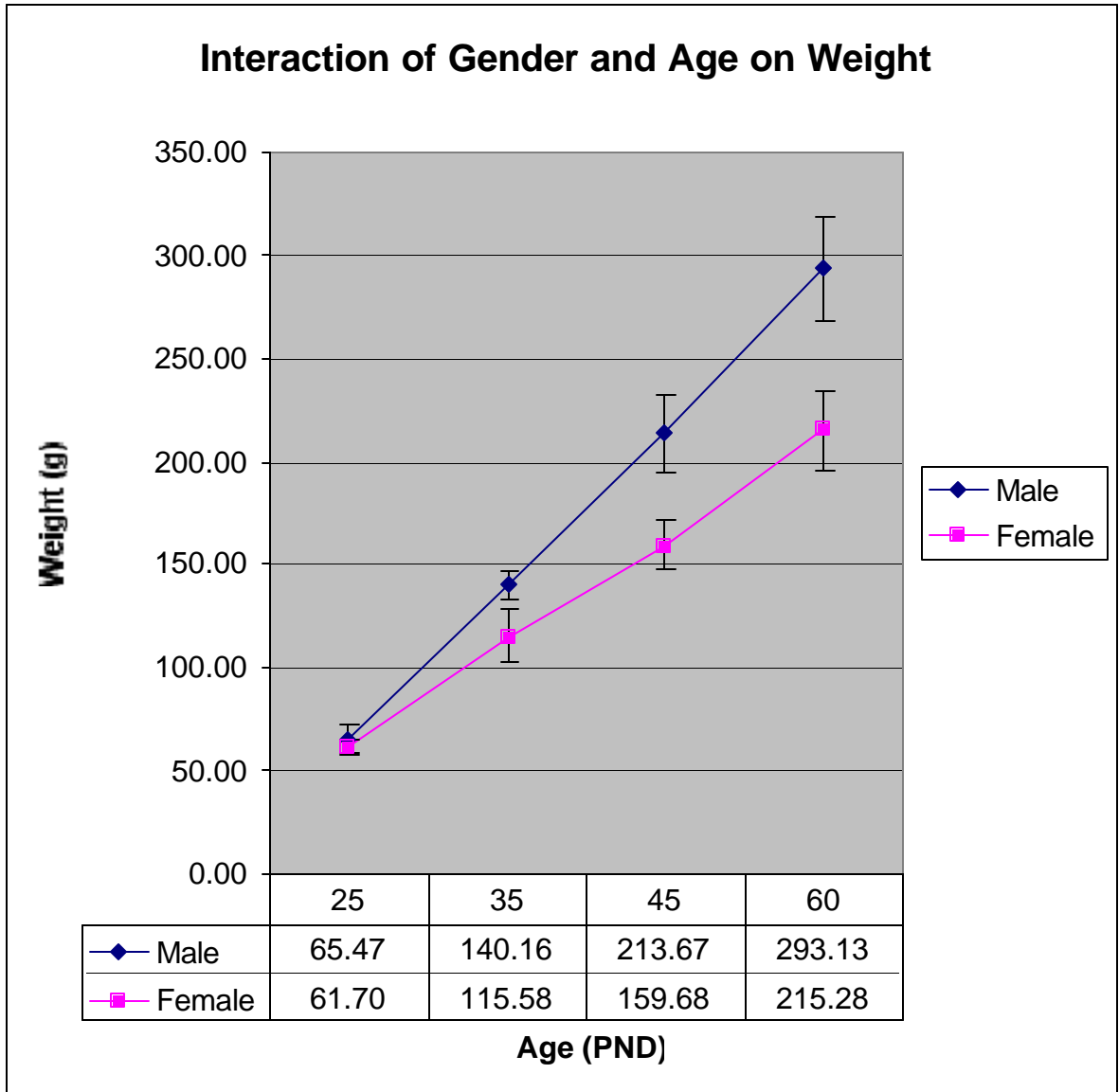

Figure Two

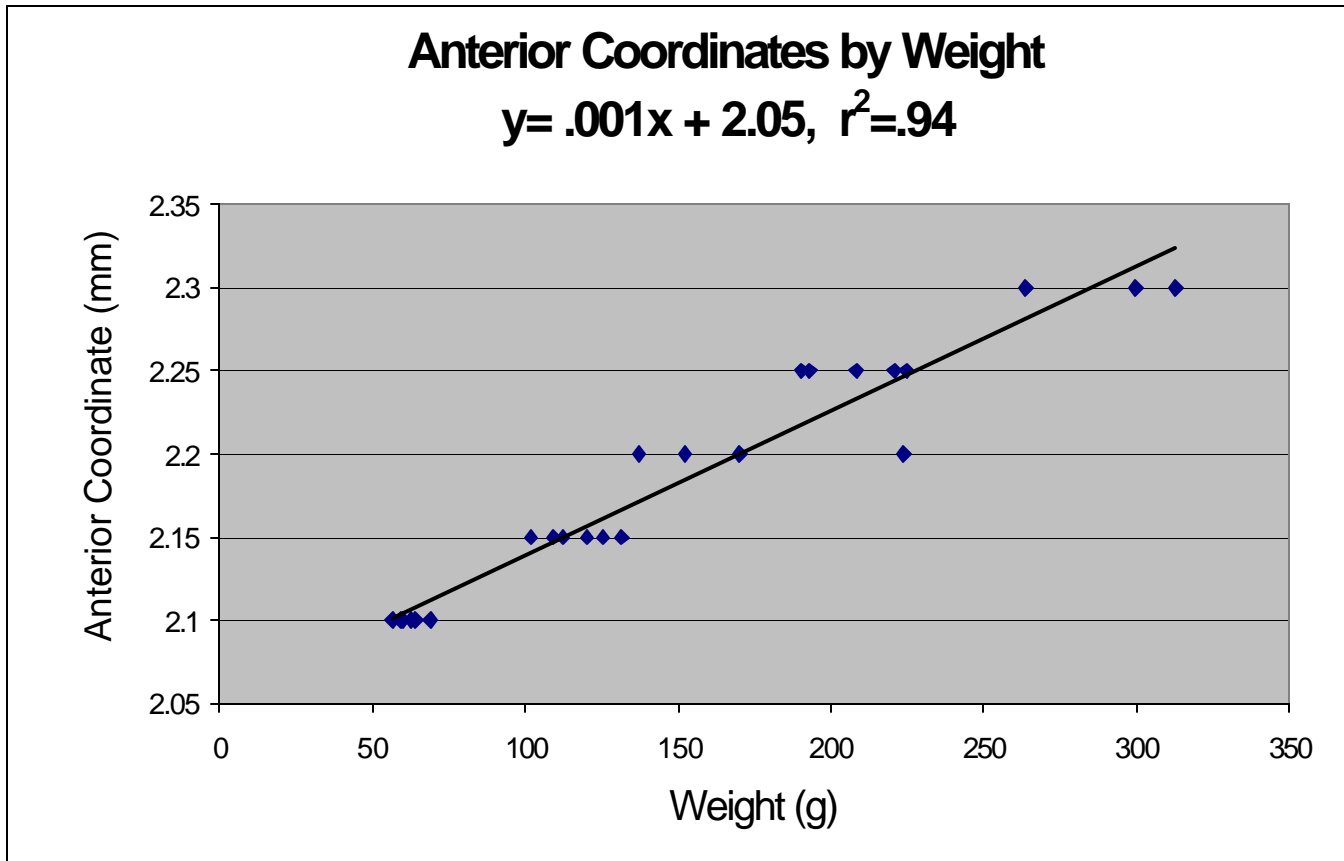

Figure Three

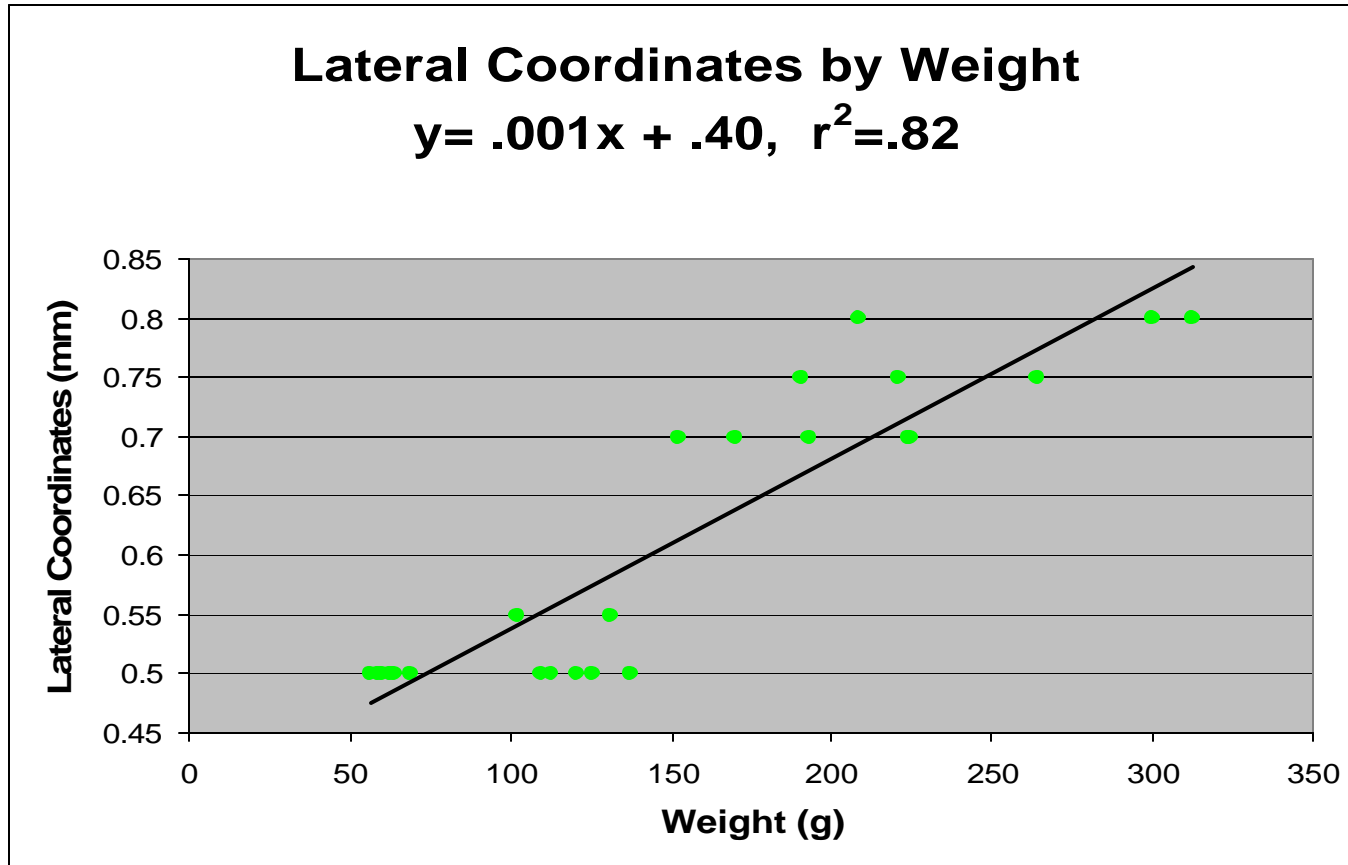
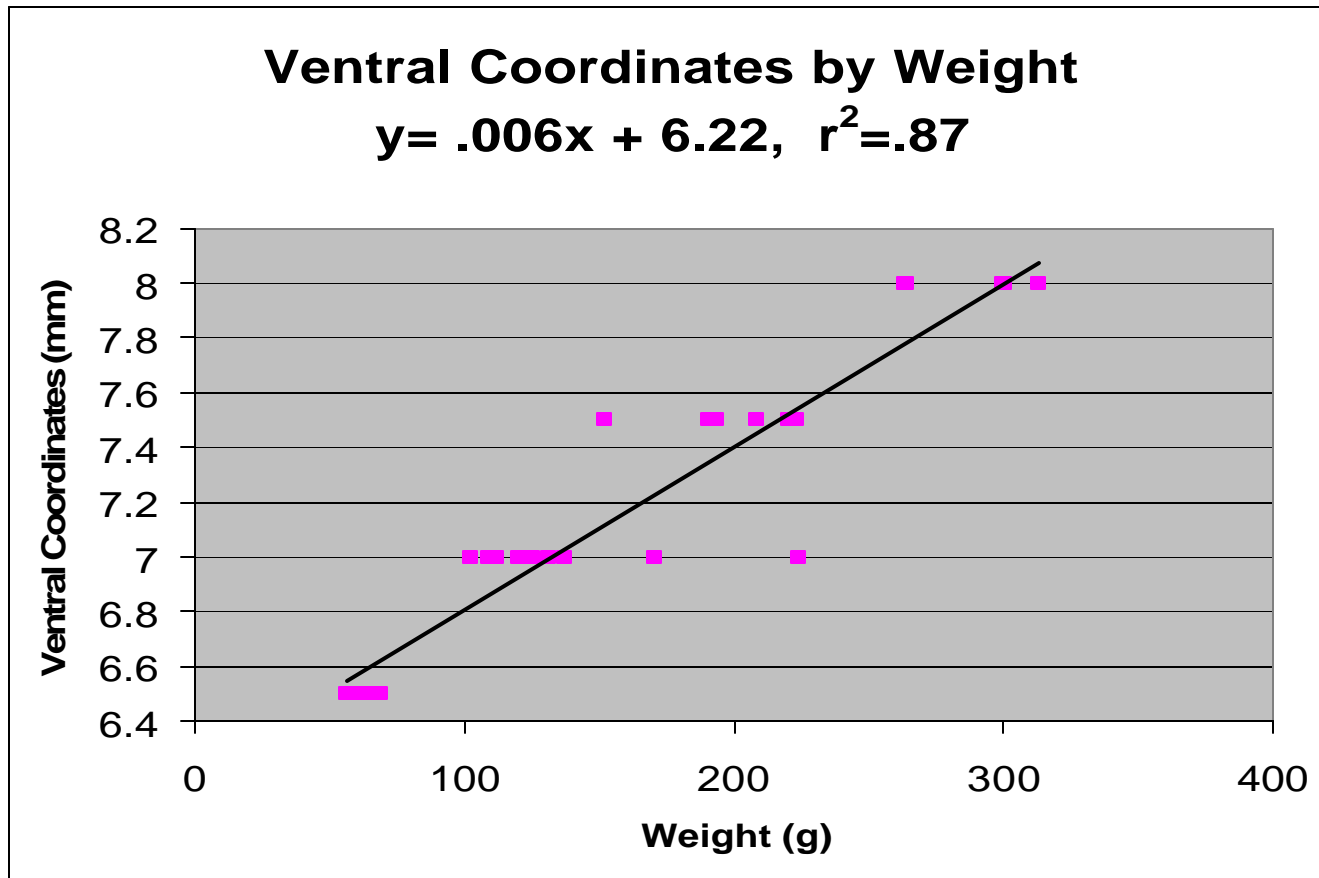

Figure Four





Appendix A (Continued)

**Table One** : Optimal Coordinates by Mean Weight

Postnatal Day	Sex	Weight	Anterior-Posterior	Medial-Lateral	Dorsal- Ventral
25	F	61.70g	2.11 +/- 0.01	0.46 +/- 0.01	6.60 +/- 0.03
	M	65.47g	2.11 +/- 0.01	0.46 +/- 0.01	6.60 +/- 0.03
35	F	115.58g	2.17 +/- 0.01	0.52 +/- 0.01	6.91 +/- 0.07
	M	140.16g	2.19 +/- 0.01	0.54 +/- 0.01	7.06 +/- 0.04
45	F	159.68g	2.21 +/- 0.01	0.56 +/- 0.01	7.18 +/- 0.07
	M	213.67g	2.26 +/- 0.02	0.61 +/- 0.02	7.50 +/- 0.11
60	F	215.28g	2.27 +/- 0.02	0.62 +/- 0.02	7.51 +/- 0.11
	M	293.28g	2.34 +/- 0.03	0.69 +/- 0.03	7.98 +/- 0.15

## Appendix A (Continued)

### Figure Captions

FIGURE ONE: Interaction of Sex and Age with Weight. During periadolescence male rats exhibit significantly larger increases in weight (g) as they age.

FIGURE TWO: Regression line for anterior/posterior coordinates calculated from successful probe placements across weight (g).  $y = 0.001x + 2.05\text{mm}$ ,  $r^2 = 0.94$ .

FIGURE THREE: Regression line for medial/lateral coordinates calculated from successful probe placements across weight (g).  $y = 0.001x + 0.40\text{mm}$ ,  $r^2 = 0.82$ .

FIGURE FOUR: Regression line for dorsal/ventral coordinates calculated from successful probe placements across weight (g).  $y = -0.006x - 6.22\text{mm}$ ,  $r^2 = 0.87$ .

TABLE ONE: Summary table providing mean weights (g) at PND 25, 35, 45 and 60 and the stereotaxic coordinates derived from these means.

## Appendix B

### **THE ATTENTIONAL MODEL OF THE NUCLEUS ACCUMBENS SEPTI AND ADDICTION**

#### **Introduction**

The attentional model of addiction states that addiction is a process resulting from the facilitation of both classical conditioning and associative learning processes by the natural neurochemical effects of drugs of abuse. A universal quality of addictive substances is the ability to enhance dopaminergic output in the nucleus accumbens septi (Robinson and Berridge 1993; Sarnyai and Kovacs 1994; Phillips and Shen 1996; Herz 1997; Tzschentke 1998; Di Chiara 1999; Di Chiara et al. 1999; Koob 1999; Leshner and Koob 1999; Nehlig 1999; Koob 2000), a limbic structure that has been shown repeatedly to mediate the initiation and maintenance of conditioned behaviors (Robinson and Berridge 1993; Sarnyai and Kovacs 1994; Phillips and Shen 1996; Di Chiara 1999; Di Chiara et al. 1999; Koob 1999; Leshner and Koob 1999; Nestler et al. 2001). For example, animals will rapidly learn to lever press for electrical stimulation of the ventral tegmental area, a mesencephalic nucleus which provides DAergic innervation to the NAcc (Kornetsky and Porrino 1992; Fiorino et al. 1993). Further, the application of DA antagonists to the NAcc attenuate the intracranial self-stimulation process (Vaccarino and Vaccarino 1989), indicating that the DAergic processes in the NAcc were critical to the maintenance of VTA self-stimulation.

## Appendix B (Continued)

Similar processes have been identified with a range of abused substances with infusions that produce elevations of DA in the NAcc resulting in the establishment and maintenance of self-administration behavior (Vaccarino and Vaccarino 1989; Singh et al. 1997). Additionally, systematic manipulations of the DAergic response in the NAcc results in predictable changes in drug SA rates, with potentiations decreasing SA (Pulvirenti and Koob 1994; Rothman and Glowa 1995), attenuation increasing SA (Corrigall and Coen 1991a; Weissenborn et al. 1996; Izzo et al. 2001) and blockade terminating SA (Corrigall and Coen 1991b; Rothman and Glowa 1995; Weissenborn et al. 1996). These data indicate a well established role for the NAcc in the process of drug taking behavior.

The exact role of the NAcc DA response in the addictive process has been the subject of debate since the discovery that specific brain regions could support behavior. The initial assumptions centered around the concepts of reward areas or pleasure centers (Wise 1978; Wise and Bozarth 1985; Wise and Rompre 1989). In essence, DA response in the NAcc produced pleasure and therefore reinforced and maintained behavior. However, this hypothesis failed to explain the marked negative affect reported by many addicts and required modification. Later hypothesis centered on the concept of dysphoria, that repeated drug use resulted in a negative affective state that was alleviated by later drug use (Koob and Le Moal 1997, 2001). This too fell by the way side as more complex hypothesis were developed. The hedonic homeostasis hypothesis was a hybrid of the positive reinforcement model and the dysphoria model and proposed that addiction was

## Appendix B (Continued)

the result of a dysregulation of mechanisms which maintained hedonic tone (Koob and Le Moal 1997).

Two prominent models currently are the associative learning model (Di Chiara 1998, 1999) and the incentive-sensitization theory (Robinson and Berridge 1993, 2000, 2001, 2003). The associative learning model has its foundation in the concept of NAcc DA mediating positive reinforcement and suggests that addiction is the result of overpowering cues associated with drug use that drive future drug using behavior. The incentive-sensitization model suggests that repeated drug use produces a facilitated DA response in the NAcc that results in increased salience of drugs and drug related stimuli, thus driving behavior. These two perspectives serve as the backbone for the attentional model of addiction which takes a slightly different view on the functional role of accumbal DA.

### Functional Roles of the NAcc

Many studies have implicated the NAcc in a diverse array of behaviors, each of which might be well explained by influences on attentional processes, rather than reward or reinforcement. For example, the NAcc responds to novelty and novel stimuli, exhibiting elevations of DA, and these elevations are not seen in response to familiar stimuli that have no direct biological significance or associations with biologically significant stimuli (Rebec et al. 1997; Young et al. 1998). Given this profile, it is possible that accumbal DA elevation is simply gating attention, increasing sensory awareness, a response important both for appetitive stimuli and unfamiliar stimuli as well. New stimuli command attention. They may be dangerous, they may have some health benefit, they

## Appendix B (Continued)

may prove useless, but until explored they are an unknown quantity. This necessitates attentional responses in the presence of novelty.

As previously discussed the predominant view of the functional role of the NAcc in the past 20 years has been as a mediator of reward (Hoebel 1985; Bozarth 1986; Hoebel et al. 1989; White 1989; Koob 1992a, 1992b; Willner et al. 1992; Berridge 1996; Koob 1996; Herz 1997; Salamone et al. 1997; Bardo 1998; Berridge and Robinson 1998; Tzschentke 1998; Di Chiara 1999; Ikemoto and Panksepp 1999; Koob 1999; Leshner and Koob 1999; Koob 2000; Schultz et al. 2000). Natural reinforcers such as food, water or sex elevate DA in the NAcc which has led to the hypothesis that this structure mediates reward and reinforcement (Tzschentke 1998). Although the NAcc may be critically involved in reward and reinforcement, it is but a subset of the currently identified reinforcement circuit (which is comprised of the anterior bed nuclei of the medial forebrain bundle, the ventral tegmental area, the NAcc and the ventral pallidum) (White 1989; Fibiger et al. 1992; Koob 1992a; Bardo 1998; Leshner and Koob 1999) and the response profile of the NAcc specifically to novelty and punishers suggests that the role of the NAcc is more than just reinforcement related.

The critical evidence for NAcc DA as mediating attentional processes is derived from the latent inhibition (LI) literature (Feldon and Weiner 1992; Young et al. 1993). There is increasing evidence that the accumbens is much more than a reward structure, or a mediator of reinforcement, but rather an integral part of a circuit that mediates attentional processes and associative learning. Specifically, increased accumbal DA may be a necessary response to emotionally salient stimuli (Weiner et al. 1996; Gray et al.

## Appendix B (Continued)

1997; Gray 1998b; Murphy et al. 2000). Significant evidence for the role of the NAcc in attentional processes comes from research using latent inhibition (LI) procedures and learned helplessness models.

In LI subjects are exposed to a non-contingent stimulus repeatedly (Preexposure Phase), following which a contingency is applied (Conditioning). For example, a rat may be repeatedly exposed to a light stimulus within a Skinner box. Following this non-contingent exposure to the light, the rat begins conditioning sessions in which the light is paired with shock. The CS preexposure results in delayed acquisition of classically conditioned responding when compared to animals that received no pretreatment. LI is the reduction in ability to learn this later contingency as a result of the prior non-contingent experience and, presumably, decreased attention to the stimulus.

Manipulations of accumbal DA influence the ability to establish LI in a fashion suggestive of attentional gating, in that DA agonists block LI (Young et al. 1993; Thornton et al. 1996; Weiner et al. 1996; Broersen et al. 1999; Di Chiara 2000) (i.e. subjects do not habituate to the non-contingent stimulus presentations) while DA antagonists facilitate LI (Young et al. 1993; Thornton et al. 1996; Weiner et al. 1996; Di Chiara 2000) (subjects take longer to learn the newly applied contingency when under the influence of DA antagonists).

Studies of the involvement of the mesolimbic DA system in learned helplessness paradigms clearly indicate that mesolimbic DA responses cannot be directly indicative of reward or reinforcement but must instead mediate a more complex process (Anisman and Zacharko 1986; Abercrombie et al. 1989; Deutch et al. 1990; Puglisi-Allegra et al. 1991).

## Appendix B (Continued)

In learned helplessness type procedures, laboratory animals are exposed to inescapable negative stimuli and changes in behavioral profiles are measured. Typically, initial exposure prompts attempts at escape, but as the inevitability of the situation is established the animal becomes passive in response to the stimulus, even when avenues for escape are provided.

Neurochemical analysis of the DA response in the NAcc to escapable vs. inescapable stress reveals two unique profiles. Research examining the effects of electric shock on accumbal DA levels indicates that aversive stimuli produce DA elevations in the NAcc (Blake and Stein 1987; Kalivas and Abhold 1987; Abercrombie et al. 1989; Deutch et al. 1990; Puglisi-Allegra et al. 1991). Exposure to shock produces a biphasic response in the NAcc, an initial elevation in DA, followed by a depression in extracellular DA. Examination of mesolimbic DAergic responses to restraint stress indicates an interesting profile. Restrained animals exhibit an initial elevation in DA that is then reduced to basal values. Following release from restraint, DA levels are again elevated above basal values. Further, chronic inescapable stress results in an attenuated DA response in the NAcc. This pattern of response is not easily explained by strict novelty or reward/punishment based theories. However, an attentional model (based on learned helplessness research) can explain this outcome. Immediately following restraint environmental attention is critical to attempt escape, hence elevated accumbal DA. However, following a period of struggle it become clear that escape is not possible at which time enhanced environmental awareness is non-functional and in fact a reduced



## Appendix B (Continued)

awareness may be adaptive. Finally, upon release environmental attention should be elevated, either to further escape or to learn the contingencies that produced escape.

In general, these profiles do not correspond well to a reinforcement/reward model of NAcc DA but could be explained under an attentional theory. New stressors or sustained avoidable or escapable stressors would require an alert attentive response to cues of the stressor or the stressor itself in order to maximize safety and minimize stress. An attentional model of NAcc DA is supported by NAcc DA profiles identified under these conditions with DA elevating in response to escape/avoidance associated cues. However, in the case of unavoidable stress, continued elevated attention in response to the stressor is not adaptive and potentially dangerous. Under such conditions the most adaptive response would be a passive reduction of sensory stimuli, or decreased environmental attention, since active avoidance is ineffective at removing the stressor. A depression of DA activity in the NAcc of humans may be protective against psychotic decompensation resulting from repeated insult by decreasing attention to ongoing stressors (O'Donnell and Grace 1998).

Attention is clearly important in associative learning processes and the NAcc again exhibits interesting profiles in associative learning procedures. Importantly, it has been repeatedly shown that the pairing of a neutral stimulus with a reinforcer or punisher results in an elevation in accumbal DA in response to the previously neutral stimulus alone. The neutral stimulus has acquired some of the neurochemical properties of the unconditioned stimulus. Clearly, in the case of a natural reinforcer like food, the neutral stimulus has no satiating properties and therefore cannot of itself acquire the reinforcing

## Appendix B (Continued)

properties of food. Therefore it seems unreasonable to suggest a transfer of reinforcement. By the same argument, although the case cannot be as clearly made, the transference of punishing properties seems unlikely, although the survival benefit in this case is obvious. It seems more likely that the system acts similarly for associations to rewards and punishers and that it serves to facilitate attention to the environment when a cue signals an upcoming event of biological importance, positive or negative. This concept is similar to Hullian or Spence's  $r_g$ - $s_g$  expectancy mediation of instrumental responding that proposes that, with repeated associations, environmental stimuli acquire the ability to induce unconditional stimulus (US) -like responses ( $r_g$ ) and corresponding internal sensations ( $s_g$ ) which constitute expectations that motivate behavior (Spence et al. 1950). In this instance, the ability of a natural reinforcer or punisher to attract attention becomes 'transferred' to congruent environmental stimuli, making them cues which attract attention and motivate US related responses.

Of considerable significance in this idea of NAcc DA mediating attention is recent research examining the NAcc role in associative learning between two neutral stimuli. Research by Young et al. (1998) has shown that the pairing of two neutral stimuli produces elevations in accumbal DA, while the two stimuli presented individually produce no response.

<u>Stimulus</u>		<u>Neurochemical Response</u>
Light	→	Stable DA
Tone	→	Stable DA
Light + Tone	→	Elevated DA

### Appendix B (Continued)

This elevation may be explained by the novel pair of stimuli, however further investigation suggests that the response could be more than just the result of novelty. Pairing one of the two neutral stimuli with shock results in a conditioned elevation in DA to the previously neutral stimulus. Interestingly, the neutral stimulus that has had no pairing with shock, but had been previously paired the shock conditioned stimulus, also acquires the ability to elevate accumbal DA when presented alone. This demonstrates second order conditioning on a neurochemical level.

<u>Conditioning</u>	<u>Test Stimulus</u>		<u>Neurochemical Response</u>
	Light	→	Stable DA
	Tone	→	Stable DA
	Shock	→	Elevated DA
Light + Tone			
Light + Shock	Light	→	Elevated DA
	Tone	→	Elevated DA

Although novelty or pairing could explain the initial elevation of DA upon presentation of the two neutral stimuli, it fails to explain the latter conditioned response of DAergic elevation to a neutral stimulus never paired with shock. An attentional model of accumbal DA activity can explain each of the patterns of elevation more clearly. The elevation that occurs as the consequence of the novel pairing is merely that, a novelty response. As previously discussed novelty should require attention because a new item, or new

## Appendix B (Continued)

situation, requires study to learn about potential rewards and pitfalls. Following conditioning the CS induced elevation signals an expectancy of an upcoming punisher, this anticipation facilitates environmental attention to aid in avoidance or escape. The second order conditioning represents the application of acquired associations to facilitate environmental awareness to aid in avoidance or escape. Attention can reasonably explain each aspect of this procedure, while other prominent views of the NAcc and DA fall short at one point or another in this structure.

### **The Role of the NAcc in Addiction**

Research by Gray (1998b) has proposed circuitry involving the NAcc as mediating attentional processes and some aspects of schizophrenia, specifically positive symptoms. Gray has suggested that complex interconnections between limbic, motor, sensory and cortical systems are involved in feedback loops for the purpose of sensory regulation. In this model, accumbal DA is involved in the gating of sensory information through a multiple component system termed the striato-thalamo-cortico-limbic loop. Although this system does not work in isolation from other inputs, the primary interconnections are as follows. Through GABAergic interconnections with the ventral pallidum, which in turn sends a GABAergic projection to the nucleus reticularis thalami, alterations in NAcc DA are capable of regulating sensory flow to the cortex (see Diagram One). The nucleus reticularis thalami is a thalamic structure that appears capable of regulating the flow of information from sensory thalamo-cortical afferents through an array of inhibitory connections with these nuclei. In theory, DA elevations in the NAcc would inhibit GABAergic projections to the ventral pallidum, in turn disinhibiting the

Appendix B (Continued)

GABAergic projections from the ventral pallidum to the nucleus reticularis thalami. This process would result in the inhibition of the nucleus reticularis thalami and the disinhibition of sensory flow to the cortex. Furthermore, cortical regions in turn modulate flow from the thalamus through reciprocal projections, as well as modulate limbic influences through feedback loops, providing multiple levels of top-down regulatory processing. This circuit as a whole has been proposed to regulate attention (Gray 1998a).

By this model, attention is defined by an increased, but regulated flow of information from the thalamus to the cortex, and regulation occurs via cortical feedback and limbic inputs. Therefore, when a stimulus elevates accumbal DA the ventral pallidum is disinhibited. This disinhibition results in less inhibition of sensory flow to the cortex by the nucleus reticularis thalami, resulting in greater sensory input. This sensory input, however, must be specific to stimuli that can effectively increase accumbal DA (i.e., the sensory systems must be directed to stimuli that can sustain and/or facilitate the activity of this circuit) or the process of elevated sensory flow will be interrupted. Therefore,

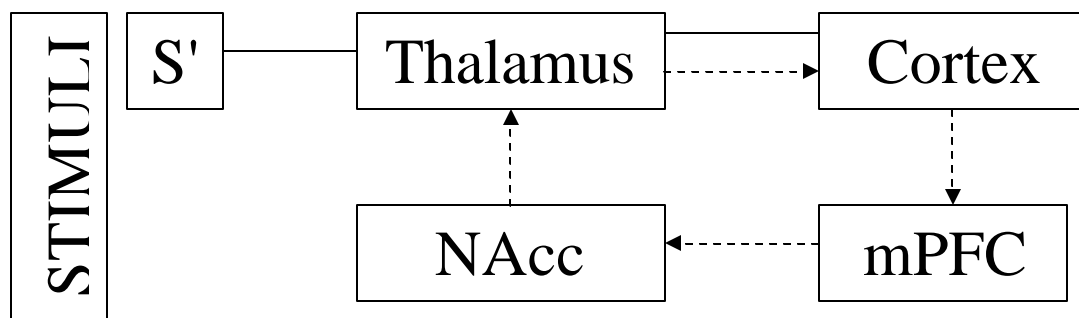

**Diagram One:** Specific environmental stimuli (S') are processed for significance by the cortex. If S' is significant, NAcc DA is facilitated, increasing cortical flow of sensory information related to the ongoing stimulus, S'.

## Appendix B (Continued)

when attention is directed to 'significant' stimuli, which elevate NAcc DA, there is increased cortical activity in relation to the sensory input of that stimulus. However, if attention shifts to a non-significant stimulus or the significance of the object is lost (e.g. habituation) the result is a decrease in cortical sensory information, decreased sensory information about the relevant stimulus and therefore decreased attention or focus. Only stimuli that can effectively increase the cortical sensory flow (i.e. novelty, natural reinforcers, environmental cues for reward or punishment, expectation, drugs of abuse, etc.) can sustain focused attention (Diagram One).

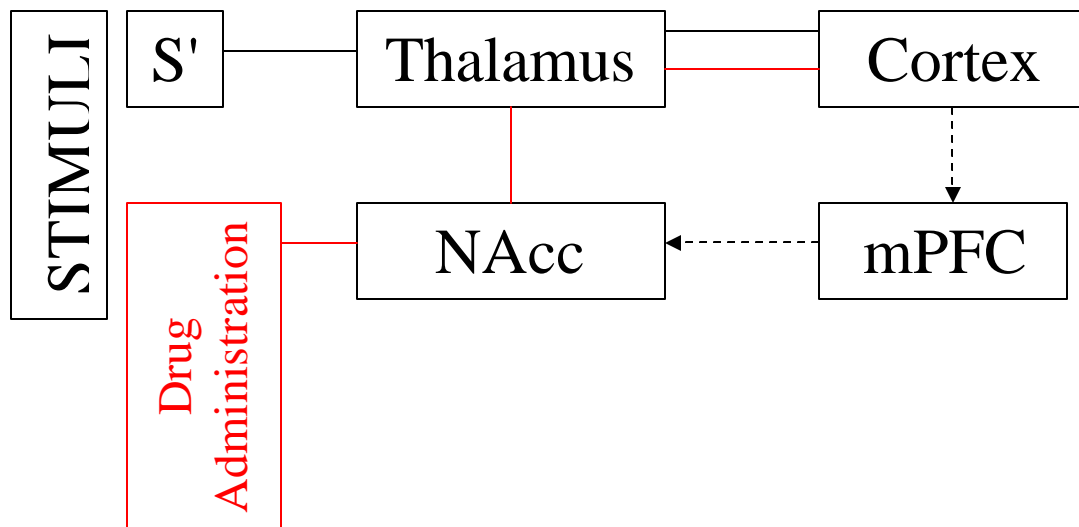

**Diagram Two:** Drug administration facilitates sensory flow to the cortex (Red) of environmental stimuli, regardless of species significance, by elevating NAcc DA

### Attentional Model of Addiction

Under normal circumstances the circuit acts to facilitate entry of sensory information to the cortex of ongoing stimuli, or focused attention. However, in the case

Appendix B (Continued)

of drugs of abuse, the gate which regulates the cortical flow of sensory information is forced open. Rather than an elegant circuit which elevates or reduces cortical sensory flow (saliency) depending on the importance of the current stimulus, the flow of sensory information is universally facilitated (Diagram Two). This serves two functions: 1) it increases the range of stimuli which can be associated with drug use and 2) it increases the likelihood that any given stimuli in the environment will be associated with drug use.

Additionally, with repeated stimulus/drug pairings, environmental stimuli acquire the innate salience-enhancing properties of drugs, the ability to elevate NAcc DA (Diagram Three). It is important to note here that Young et. al. demonstrated that NAcc

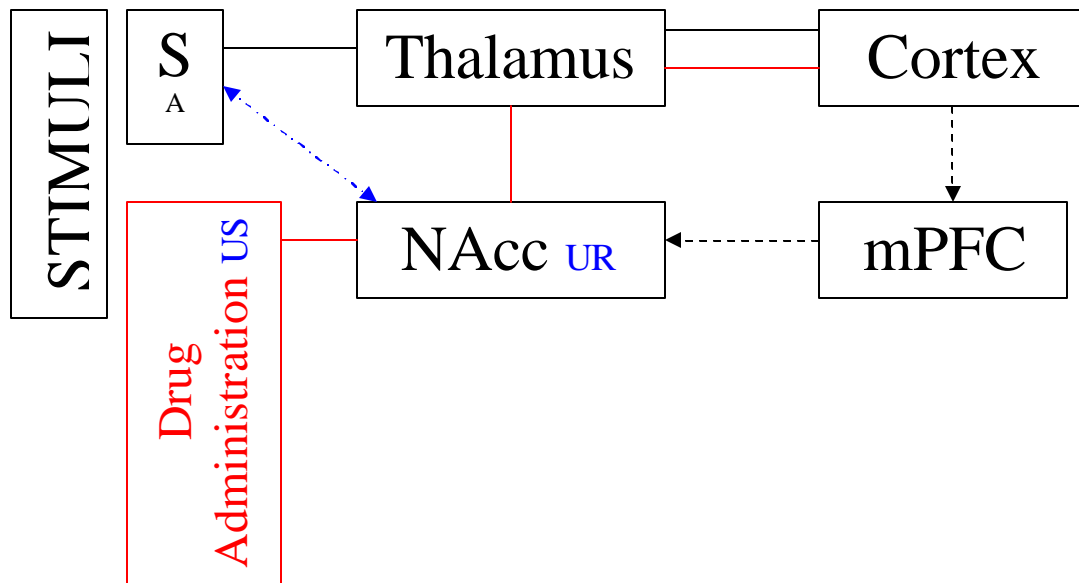

**Diagram Three:** Repeated drug administration sets the foundation for classical conditioning (Blue) between specific environmental stimuli (S<sup>A</sup>) and the drug induced elevation in NAcc DA.

conditioning can occur simply via co-occurrence, without contingent reinforcement or punishment. Further, the potency of each individual classical conditioning trial is

#### Appendix B (Continued)

enhanced by the salience enhancing effects of the drug, resulting in fairly rapid and powerful conditioning. Therefore, after a series of stimulus/drug pairings, specific environmental stimuli acquire the ability to elevate NAcc DA and thus enhance their salience by facilitating stimulus related cortical flow. Consequently, drug-associated environmental stimuli become highly salient in the environment and since they are associated with drugs and drug using behavior they drive drug-related thoughts and ultimately further drug using behavior. This in turn facilitates the strength of current associations and provides for other associations to become drug-related incentives (Diagrams Four and Five, following pages).



Appendix B (Continued)

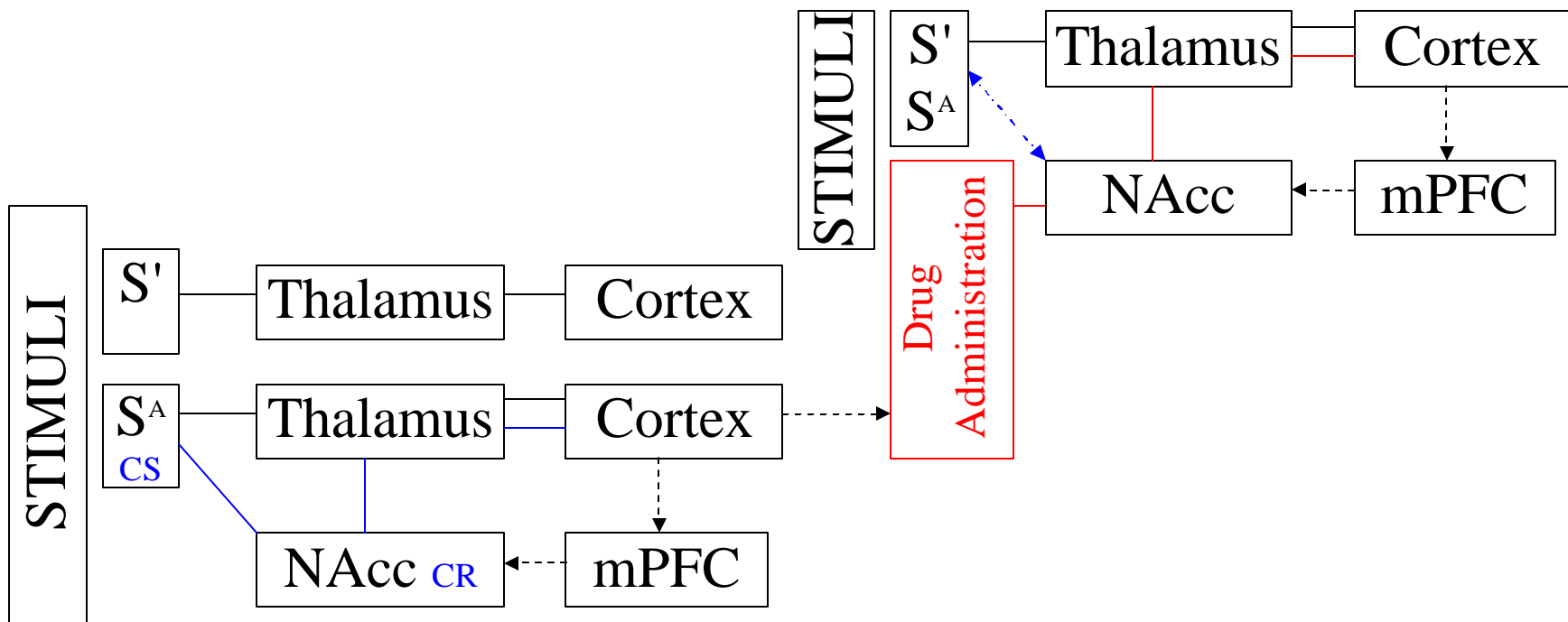

**Diagram Four:** Chronic use of a drug in the presence of specific environmental stimuli (S<sup>A</sup>) results in the classical conditioning of the NAcc DA response to the environmental stimuli. Therefore, these stimuli now facilitate their own increased sensory overflow to the cortex, causing ongoing thoughts to be predominantly about drug related stimuli and drugs, overshadowing sensory processes of other competing stimuli (S'). These ongoing thoughts increase the probability that ongoing behavior will be related to drug use and the response of drug use may alleviate tension produced by obsessive thoughts of drugs. Use sets up reinforcement of current conditioning as well as conditioning of new environmental stimuli.

Appendix B (Continued)

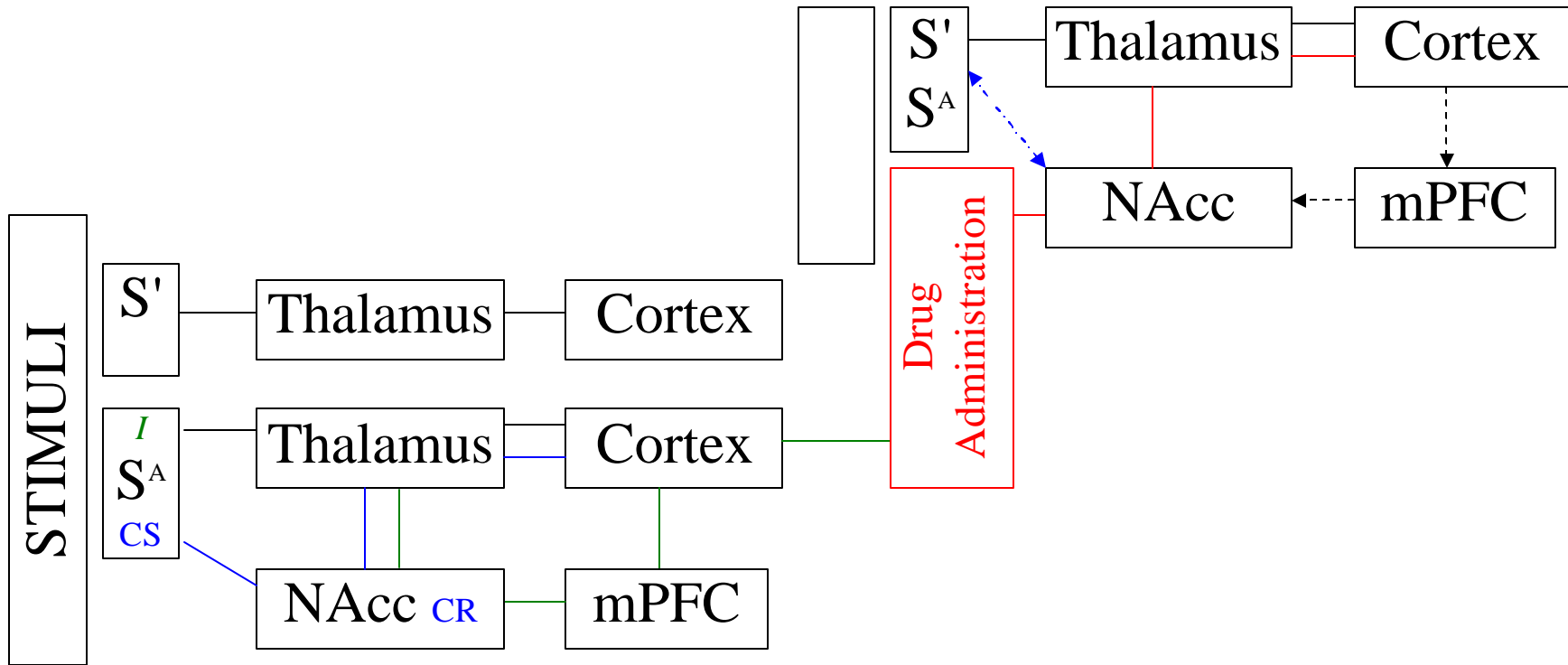

**Diagram Five:** The ability of drug administration to relieve focus on drug related environmental stimuli serves as a negative reinforcer for drug administration. This results in the establishment of drug related stimuli as incentives (*I*) for drug using behavior. Specifically, the presence of drug related stimuli sets the occasion for negative events that can be alleviated by drug use. Therefore, drug administration in the presence of drug related stimuli becomes an automatic process and this process of use serves to facilitate already established associations and produce new associations that can drive drug using behavior.

## Appendix B (Continued)

### References

- Abercrombie, E. D., K. A. Keefe, D. S. DiFrischia and M. J. Zigmond (1989). Differential effect of stress on in vivo dopamine release in striatum, nucleus accumbens, and medial frontal cortex. *J Neurochem* **52**(5): 1655-8.
- Anisman, H. and R. M. Zacharko (1986). Behavioral and neurochemical consequences associated with stressors. *Ann N Y Acad Sci* **467**: 205-25.
- Bardo, M. T. (1998). Neuropharmacological mechanisms of drug reward: Beyond dopamine in the nucleus accumbens. *Crit Rev Neurobiol* **12**(1-2): 37-67.
- Berridge, K. C. (1996). Food reward: Brain substrates of wanting and liking. *Neurosci Biobehav Rev* **20**(1): 1-25.
- Berridge, K. C. and T. E. Robinson (1998). What is the role of dopamine in reward: Hedonic impact, reward learning, or incentive salience? *Brain Res Brain Res Rev* **28**(3): 309-69.
- Blake, M. J. and E. A. Stein (1987). Brain stimulation of the ventral tegmental area attenuates footshock escape: An in vivo autoradiographic analysis of opiate receptors. *Brain Res* **435**(1-2): 181-94.
- Bozarth, M. A. (1986). Neural basis of psychomotor stimulant and opiate reward: Evidence suggesting the involvement of a common dopaminergic system. *Behav Brain Res* **22**(2): 107-16.
- Broersen, L. M., J. Feldon and I. Weiner (1999). Dissociative effects of apomorphine infusions into the medial prefrontal cortex of rats on latent inhibition, prepulse inhibition and amphetamine-induced locomotion. *Neuroscience* **94**(1): 39-46.
- Corrigall, W. A. and K. M. Coen (1991a). Cocaine self-administration is increased by both d1 and d2 dopamine antagonists. *Pharmacol Biochem Behav* **39**(3): 799-802.
- Corrigall, W. A. and K. M. Coen (1991b). Selective dopamine antagonists reduce nicotine self-administration. *Psychopharmacology* **104**(2): 171-6.
- Deutch, A. Y., W. A. Clark and R. H. Roth (1990). Prefrontal cortical dopamine depletion enhances the responsiveness of mesolimbic dopamine neurons to stress. *Brain Res* **521**(1-2): 311-5.
- Di Chiara, G. (1998). A motivational learning hypothesis of the role of mesolimbic dopamine in compulsive drug use. *J Psychopharmacol* **12**(1): 54-67.
- Di Chiara, G. (1999). Drug addiction as dopamine-dependent associative learning disorder. *Eur J Pharmacol* **375**(1-3): 13-30.

## Appendix B (Continued)

- Di Chiara, G. (2000). Role of dopamine in the behavioural actions of nicotine related to addiction. *Eur J Pharmacol* **393**(1-3): 295-314.
- Di Chiara, G., G. Tanda, V. Bassareo, F. Pontieri, E. Acquas, S. Fenu, C. Cadoni and E. Carboni (1999). Drug addiction as a disorder of associative learning. Role of nucleus accumbens shell/extended amygdala dopamine. *Ann N Y Acad Sci* **877**: 461-85.
- Feldon, J. and I. Weiner (1992). From an animal model of an attentional deficit towards new insights into the pathophysiology of schizophrenia. *J Psychiatr Res* **26**(4): 345-66.
- Fibiger, H. C., A. G. Phillips and E. E. Brown (1992). The neurobiology of cocaine-induced reinforcement. *Ciba Found Symp* **166**: 96-111.
- Fiorino, D. F., A. Coury, H. C. Fibiger and A. G. Phillips (1993). Electrical stimulation of reward sites in the ventral tegmental area increases dopamine transmission in the nucleus accumbens of the rat. *Behav Brain Res* **55**(2): 131-41.
- Gray, J. A. (1998a). Abnormal contents of consciousness: The transition from automatic to controlled processing. *Adv Neurol* **77**: 195-208.
- Gray, J. A. (1998b). Integrating schizophrenia. *Schizophr Bull* **24**(2): 249-66.
- Gray, J. A., P. M. Moran, G. Grigoryan, S. L. Peters, A. M. Young and M. H. Joseph (1997). Latent inhibition: The nucleus accumbens connection revisited. *Behav Brain Res* **88**(1): 27-34.
- Herz, A. (1997). Endogenous opioid systems and alcohol addiction. *Psychopharmacology (Berl)* **129**(2): 99-111.
- Hoebel, B. G. (1985). Brain neurotransmitters in food and drug reward. *Am J Clin Nutr* **42**(5 Suppl): 1133-50.
- Hoebel, B. G., L. Hernandez, D. H. Schwartz, G. P. Mark and G. A. Hunter (1989). Microdialysis studies of brain norepinephrine, serotonin, and dopamine release during ingestive behavior. Theoretical and clinical implications. *Ann N Y Acad Sci* **575**: 171-91.
- Ikemoto, S. and J. Panksepp (1999). The role of nucleus accumbens dopamine in motivated behavior: A unifying interpretation with special reference to reward-seeking. *Brain Res Brain Res Rev* **31**(1): 6-41.
- Izzo, E., C. Orsini, G. F. Koob and L. Pulvirenti (2001). A dopamine partial agonist and antagonist block amphetamine self-administration in a progressive ratio schedule. *Pharmacol Biochem Behav* **68**(4): 701-8.
- Kalivas, P. W. and R. Abhold (1987). Enkephalin release into the ventral tegmental area in response to stress: Modulation of mesocorticolimbic dopamine. *Brain Res* **414**(2): 339-48.

## Appendix B (Continued)

- Koob, G. F. (1992a). Drugs of abuse: Anatomy, pharmacology and function of reward pathways. *Trends Pharmacol Sci* **13**(5): 177-84.
- Koob, G. F. (1992b). Neural mechanisms of drug reinforcement. *Ann N Y Acad Sci* **654**: 171-91.
- Koob, G. F. (1996). Hedonic valence, dopamine and motivation. *Mol Psychiatry* **1**(3): 186-9.
- Koob, G. F. (1999). The role of the striatopallidal and extended amygdala systems in drug addiction. *Ann N Y Acad Sci* **877**: 445-60.
- Koob, G. F. (2000). Neurobiology of addiction. Toward the development of new therapies. *Ann N Y Acad Sci* **909**: 170-85.
- Koob, G. F. and M. Le Moal (1997). Drug abuse: Hedonic homeostatic dysregulation. *Science* **278**(5335): 52-8.
- Koob, G. F. and M. Le Moal (2001). Drug addiction, dysregulation of reward, and allostasis. *Neuropsychopharmacology* **24**(2): 97-129.
- Kornetsky, C. and L. J. Porrino (1992). Brain mechanisms of drug-induced reinforcement. *Res Publ Assoc Res Nerv Ment Dis* **70**: 59-77.
- Leshner, A. I. and G. F. Koob (1999). Drugs of abuse and the brain. *Proc Assoc Am Physicians* **111**(2): 99-108.
- Murphy, C. A., M. Pezze, J. Feldon and C. Heidbreder (2000). Differential involvement of dopamine in the shell and core of the nucleus accumbens in the expression of latent inhibition to an aversively conditioned stimulus. *Neuroscience* **97**(3): 469-477.
- Nehlig, A. (1999). Are we dependent upon coffee and caffeine? A review on human and animal data. *Neurosci Biobehav Rev* **23**(4): 563-76.
- Nestler, E. J., M. Barrot and D. W. Self (2001). Deltafosf: A sustained molecular switch for addiction. *Proc Natl Acad Sci U S A* **98**(20): 11042-6.
- O'Donnell, P. and A. A. Grace (1998). Dysfunctions in multiple interrelated systems as the neurobiological bases of schizophrenic symptom clusters. *Schizophr Bull* **24**(2): 267-83.
- Phillips, T. J. and E. H. Shen (1996). Neurochemical bases of locomotion and ethanol stimulant effects. *Int Rev Neurobiol* **39**: 243-82.
- Puglisi-Allegra, S., A. Imperato, L. Angelucci and S. Cabib (1991). Acute stress induces time-dependent responses in dopamine mesolimbic system. *Brain Res* **554**(1-2): 217-22.
- Pulvirenti, L. and G. F. Koob (1994). Dopamine receptor agonists, partial agonists and psychostimulant addiction. *Trends Pharmacol Sci* **15**(10): 374-9.

## Appendix B (Continued)

- Rebec, G. V., J. R. Christensen, C. Guerra and M. T. Bardo (1997). Regional and temporal differences in real-time dopamine efflux in the nucleus accumbens during free-choice novelty. *Brain Res* **776**(1-2): 61-7.
- Robinson, T. E. and K. C. Berridge (1993). The neural basis of drug craving: An incentive-sensitization theory of addiction. *Brain Res Brain Res Rev* **18**(3): 247-91.
- Robinson, T. E. and K. C. Berridge (2000). The psychology and neurobiology of addiction: An incentive-sensitization view. *Addiction* **95 Suppl 2**: S91-117.
- Robinson, T. E. and K. C. Berridge (2001). Incentive-sensitization and addiction. *Addiction* **96**(1): 103-14.
- Robinson, T. E. and K. C. Berridge (2003). Addiction. *Annu Rev Psychol* **54**: 25-53.
- Rothman, R. B. and J. R. Glowa (1995). A review of the effects of dopaminergic agents on humans, animals, and drug-seeking behavior, and its implications for medication development. Focus on gbr 12909. *Mol Neurobiol* **11**(1-3): 1-19.
- Salamone, J. D., M. S. Cousins and B. J. Snyder (1997). Behavioral functions of nucleus accumbens dopamine: Empirical and conceptual problems with the anhedonia hypothesis. *Neurosci Biobehav Rev* **21**(3): 341-59.
- Sarnyai, Z. and G. L. Kovacs (1994). Role of oxytocin in the neuroadaptation to drugs of abuse. *Psychoneuroendocrinology* **19**(1): 85-117.
- Schultz, W., L. Tremblay and J. R. Hollerman (2000). Reward processing in primate orbitofrontal cortex and basal ganglia. *Cereb Cortex* **10**(3): 272-84.
- Singh, J., T. Desiraju and T. R. Raju (1997). Dopamine receptor sub-types involvement in nucleus accumbens and ventral tegmentum but not in medial prefrontal cortex: On self- stimulation of lateral hypothalamus and ventral mesencephalon. *Behav Brain Res* **86**(2): 171-9.
- Spence, K. W., G. Bergmann and R. Lippitt (1950). A study of simple learning under irrelevant motivational-reward conditions. *J Exp Psychol* **40**(5): 539-51.
- Thornton, J. C., S. Dawe, C. Lee, C. Capstick, P. J. Corr, P. Cotter, S. Frangou, N. S. Gray, M. A. Russell and J. A. Gray (1996). Effects of nicotine and amphetamine on latent inhibition in human subjects. *Psychopharmacology (Berl)* **127**(2): 164-73.
- Tzschentke, T. M. (1998). Measuring reward with the conditioned place preference paradigm: A comprehensive review of drug effects, recent progress and new issues. *Prog Neurobiol* **56**(6): 613-72.
- Vaccarino, F. J. and A. L. Vaccarino (1989). Antagonism of cholecystokinin function in the rostral and caudal nucleus accumbens: Differential effects on brain stimulation reward. *Neurosci Lett* **97**(1-2): 151-6.

## Appendix B (Continued)

- Weiner, I., G. Gal, J. N. Rawlins and J. Feldon (1996). Differential involvement of the shell and core subterritories of the nucleus accumbens in latent inhibition and amphetamine-induced activity. *Behav Brain Res* **81**(1-2): 123-33.
- Weissenborn, R., V. Deroche, G. F. Koob and F. Weiss (1996). Effects of dopamine agonists and antagonists on cocaine-induced operant responding for a cocaine-associated stimulus. *Psychopharmacology (Berl)* **126**(4): 311-22.
- White, N. M. (1989). Reward or reinforcement: What's the difference? *Neurosci Biobehav Rev* **13**(2-3): 181-6.
- Willner, P., R. Muscat and M. Papp (1992). Chronic mild stress-induced anhedonia: A realistic animal model of depression. *Neurosci Biobehav Rev* **16**(4): 525-34.
- Wise, R. A. (1978). Catecholamine theories of reward: A critical review. *Brain Res* **152**(2): 215-47.
- Wise, R. A. and M. A. Bozarth (1985). Brain mechanisms of drug reward and euphoria. *Psychiatr Med* **3**(4): 445-60.
- Wise, R. A. and P. P. Rompre (1989). Brain dopamine and reward. *Annu Rev Psychol* **40**: 191-225.
- Young, A. M., R. G. Ahier, R. L. Upton, M. H. Joseph and J. A. Gray (1998). Increased extracellular dopamine in the nucleus accumbens of the rat during associative learning of neutral stimuli. *Neuroscience* **83**(4): 1175-83.
- Young, A. M., M. H. Joseph and J. A. Gray (1993). Latent inhibition of conditioned dopamine release in rat nucleus accumbens. *Neuroscience* **54**(1): 5-9.

## **ABOUT THE AUTHOR**

Rex Montgomery Philpot was born September 14<sup>th</sup>, 1970 in the city of Rockledge, on the east coast of Florida. He began his formal education one score and eight years ago, a process that has continued, unceasingly, until the publication of this body of work. During this journey, three events worthy of mention have occurred, his marriage of thirteen years to his childhood love, Elizabeth Ann Laughlin, and the birth of his two children. Rebecca Ann Philpot was born June 22<sup>nd</sup>, 1991 in Rockledge, Florida and Grace Taylor Philpot was born March, 26<sup>th</sup>, 1998 in the city of Tampa on the west coast of Florida. This dissertation marks the end of one journey and the eager anticipation of a new future, in which many new memories will be formed and memorialized elsewhere, in time and place.