USF Patents

4-17-2001

Variable microwave cold/warm noise source

Robert S. Roeder

Matthew C. Smith

Lawrence P. Dunleavy

Steven M. Lardizabal

Follow this and additional works at: http://scholarcommons.usf.edu/usf_patents

Recommended Citation

Roeder, Robert S.; Smith, Matthew C.; Dunleavy, Lawrence P.; and Lardizabal, Steven M., "Variable microwave cold/warm noise source" (2001). *USF Patents*. 804.

http://scholarcommons.usf.edu/usf_patents/804

This Patent is brought to you for free and open access by Scholar Commons. It has been accepted for inclusion in USF Patents by an authorized administrator of Scholar Commons. For more information, please contact scholarcommons@usf.edu.



US006217210B1

(12) **United States Patent**
Roeder et al.

(10) **Patent No.:** **US 6,217,210 B1**
(45) **Date of Patent:** **Apr. 17, 2001**

(54) **VARIABLE MICROWAVE COLD/WARM NOISE SOURCE**

FOREIGN PATENT DOCUMENTS

0 523 221 1/1993 (EP) .

(75) Inventors: **Robert S. Roeder**, Dunedin; **Matthew C. Smith**, Largo; **Lawrence P. Dunleavy**, Land of Lakes; **Steven M. Lardizabal**, Tampa, all of FL (US)

OTHER PUBLICATIONS

Winson, et al., "A Table-Based Bias and Temperature-Dependent Small-Signal and Noise Equivalent Circuit Model," *IEEE*, vol. 45, No. 1, Jan. 1997.

(73) Assignees: **Raytheon Company**, Lexington, MA (US); **University of South Florida**, Tampa, FL (US)

Blundell, "The United Kingdom National Standard of Microwave Noise at 4.1 GHz and 77k," *Journal of Physics for Scientific Instruments*, vol. 8, 1975.

(*) Notice: Subject to any disclaimer, the term of this patent is extended or adjusted under 35 U.S.C. 154(b) by 0 days.

Robert H. Frater and David R. Williams, "An Active 'Cold' Noise Source", 1981 IEEE, pp. 344-347.

David R. Williams, "Calibration of C-Band 3.7-4.2GHz, Hot-Cold Head S/N101", Berkshire Technologies, Inc., May 15, 1988.

(21) Appl. No.: **09/319,520**

Primary Examiner—Diego Gutierrez

(22) PCT Filed: **Nov. 28, 1997**

Assistant Examiner—Lydia M. De Jesús

(86) PCT No.: **PCT/US97/20969**

(74) *Attorney, Agent, or Firm*—Baker Botts L.L.P.

§ 371 Date: **Aug. 23, 1999**

§ 102(e) Date: **Aug. 23, 1999**

(87) PCT Pub. No.: **WO98/27414**

PCT Pub. Date: **Jun. 25, 1998**

(57) **ABSTRACT**

A radiometer calibrating system utilizes an adjustable noise source for calibrating a radiometer. The noise source includes a transistor configured as a noise equivalent circuit having a gate port, drain port and source port. A source inductance providing series feedback for the noise source has one end coupled to the source port of the noise equivalent circuit and another end connected to the ground. A bias circuit controls the amount of DC bias applied to the noise equivalent circuit. In order to match the impedances in the noise source, an output impedance matching network in connected to the drain port and an input impedance matching network is connected to the gate port of the noise equivalent circuit. The output and input impedance networks have an output port and input port, respectively. Included in the noise source is a port switch that terminates a matched load to the output port when a cold thermal radiation temperature is generated at the input port, and alternatively, the port switch terminates the matched load to the input port when the warm thermal radiation temperature is generated at the output port.

Related U.S. Application Data

(60) Provisional application No. 60/032,262, filed on Dec. 3, 1996.

(51) **Int. Cl.**⁷ **G01K 15/00; G01K 7/30**

(52) **U.S. Cl.** **374/1; 374/175**

(58) **Field of Search** **374/1, 175**

(56) **References Cited**

U.S. PATENT DOCUMENTS

3,409,827	11/1968	Goggings, Jr.	324/58.5
3,525,037	8/1970	Madden et al.	324/7
3,564,420	2/1971	Webb	325/363
3,693,095	9/1972	Wilt	325/363

(List continued on next page.)

22 Claims, 7 Drawing Sheets

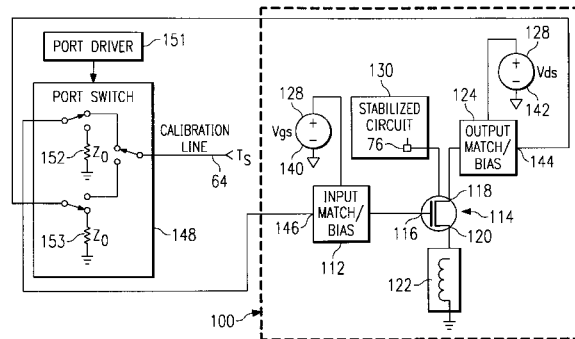
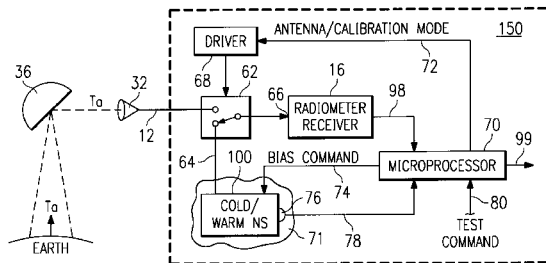

U.S. PATENT DOCUMENTS							
		5,341,814	8/1994	Van De Velde et al.	128/736		
3,777,270	12/1973	Hardy et al.	325/363	5,354,325	10/1994	Chive et al.	607/101
4,272,731	6/1981	Day et al.	331/78	5,688,050	11/1997	Sterzer et al.	374/122
5,128,884	7/1992	Prager	364/571	5,949,845	* 9/1999	Sterzer	378/37
5,176,146	* 1/1993	Chivé Maurice et al.	600/549				
5,270,528	12/1993	Ogikubo	250/201				

* cited by examiner

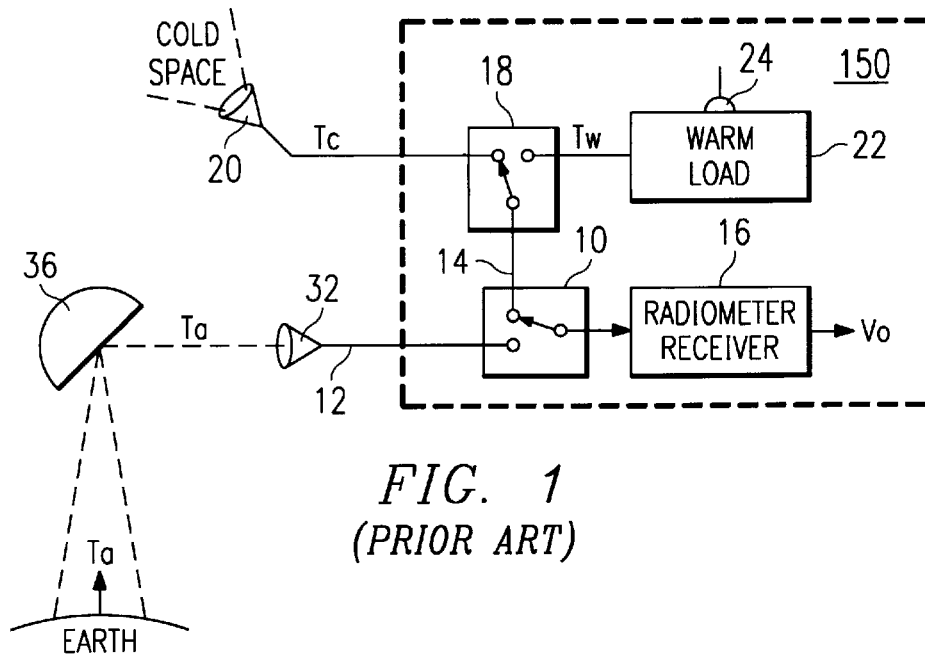

FIG. 1
(PRIOR ART)

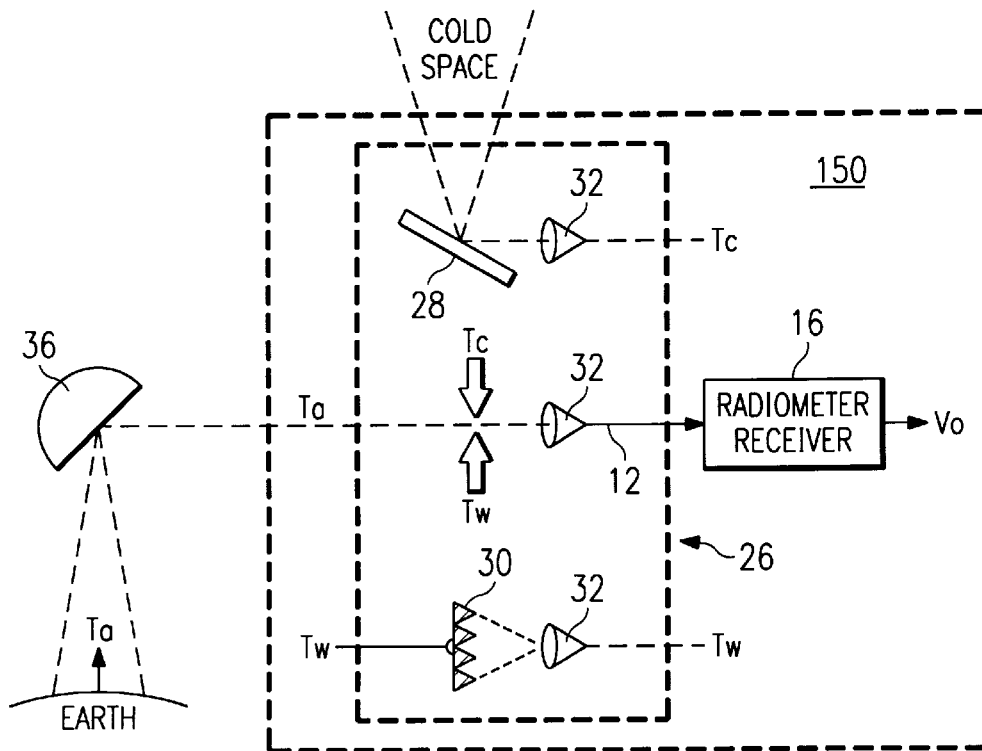
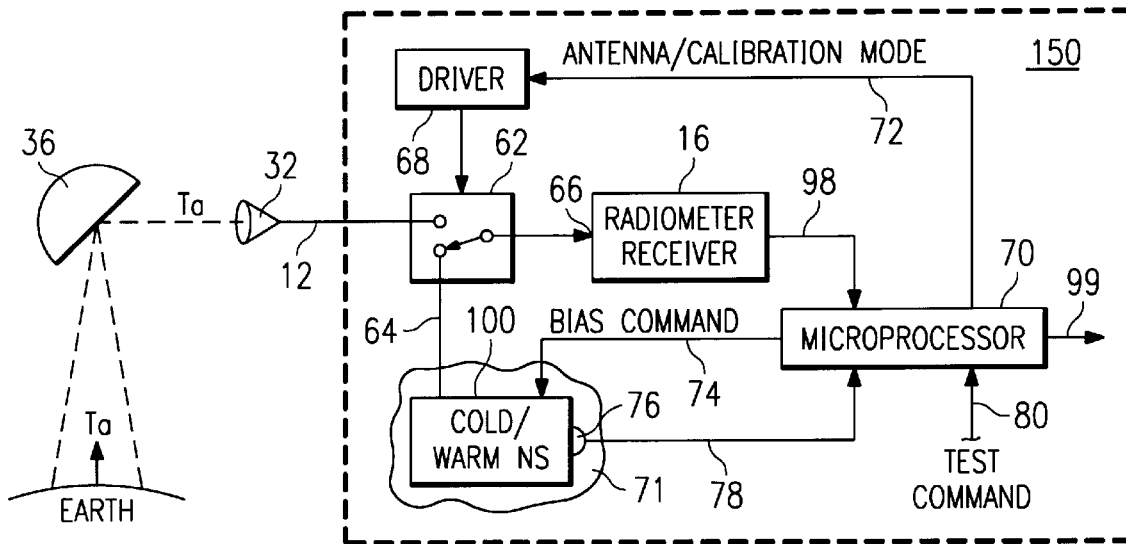
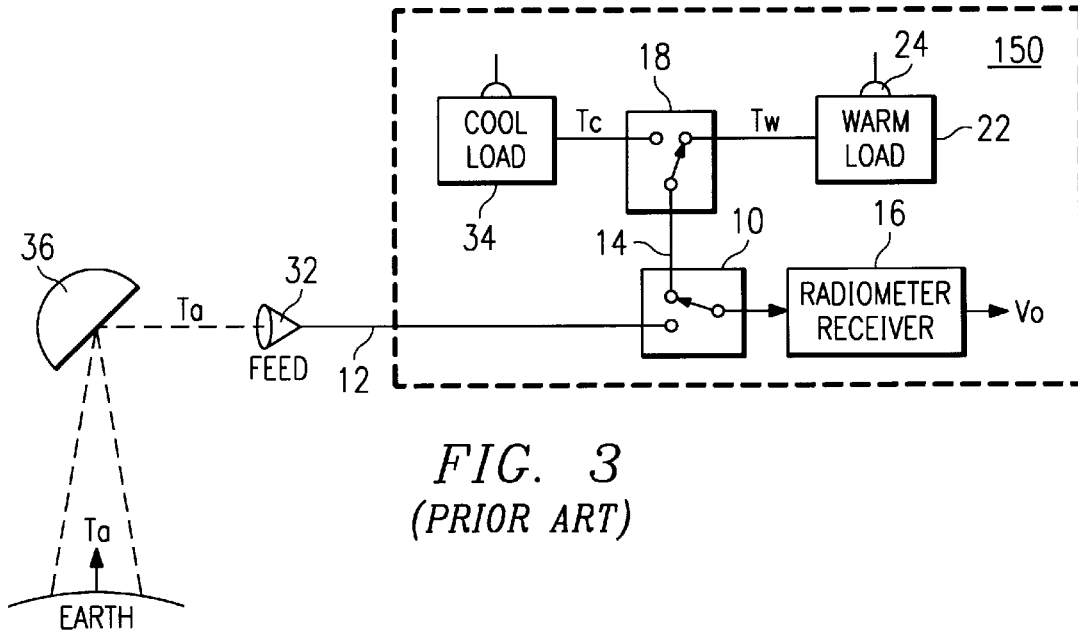

FIG. 2
(PRIOR ART)



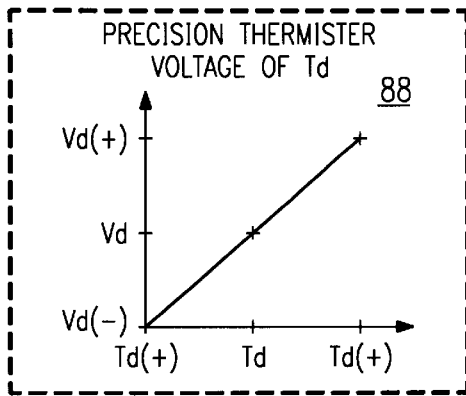

FIG. 5A

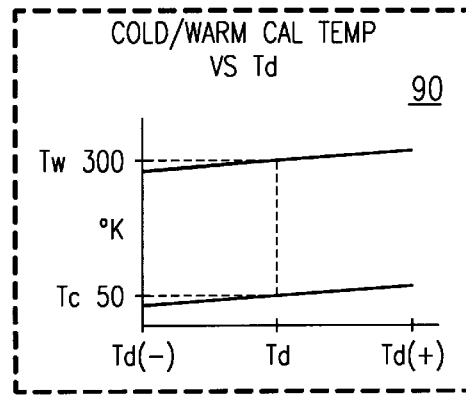

FIG. 5B

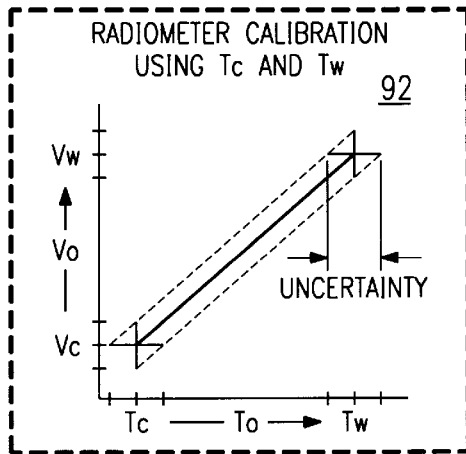

FIG. 5C

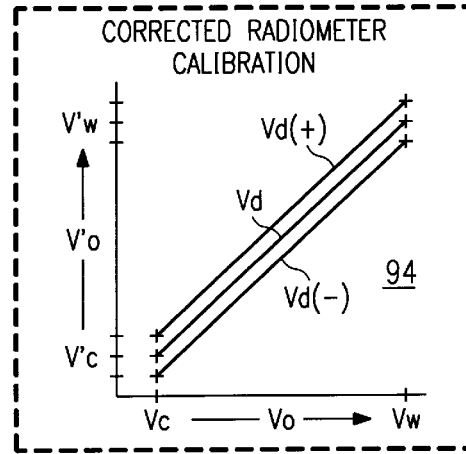

FIG. 5D



FIG. 6A

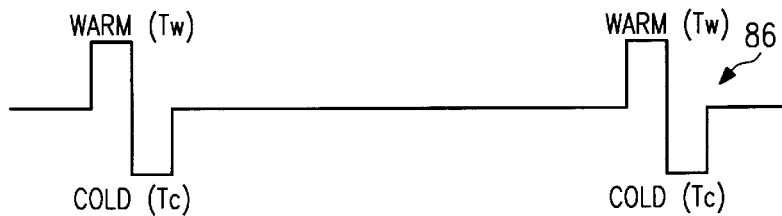

FIG. 6B

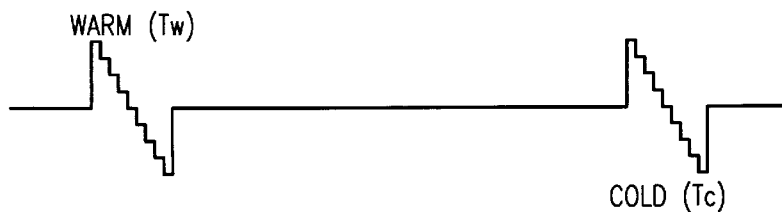

FIG. 6C

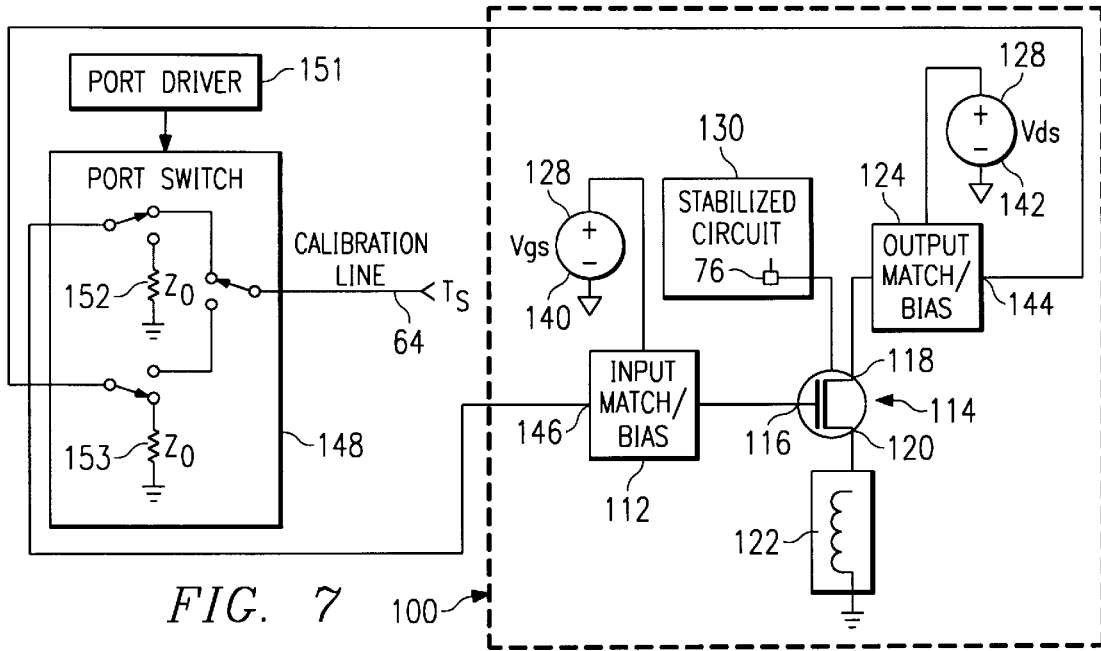

FIG. 7 100

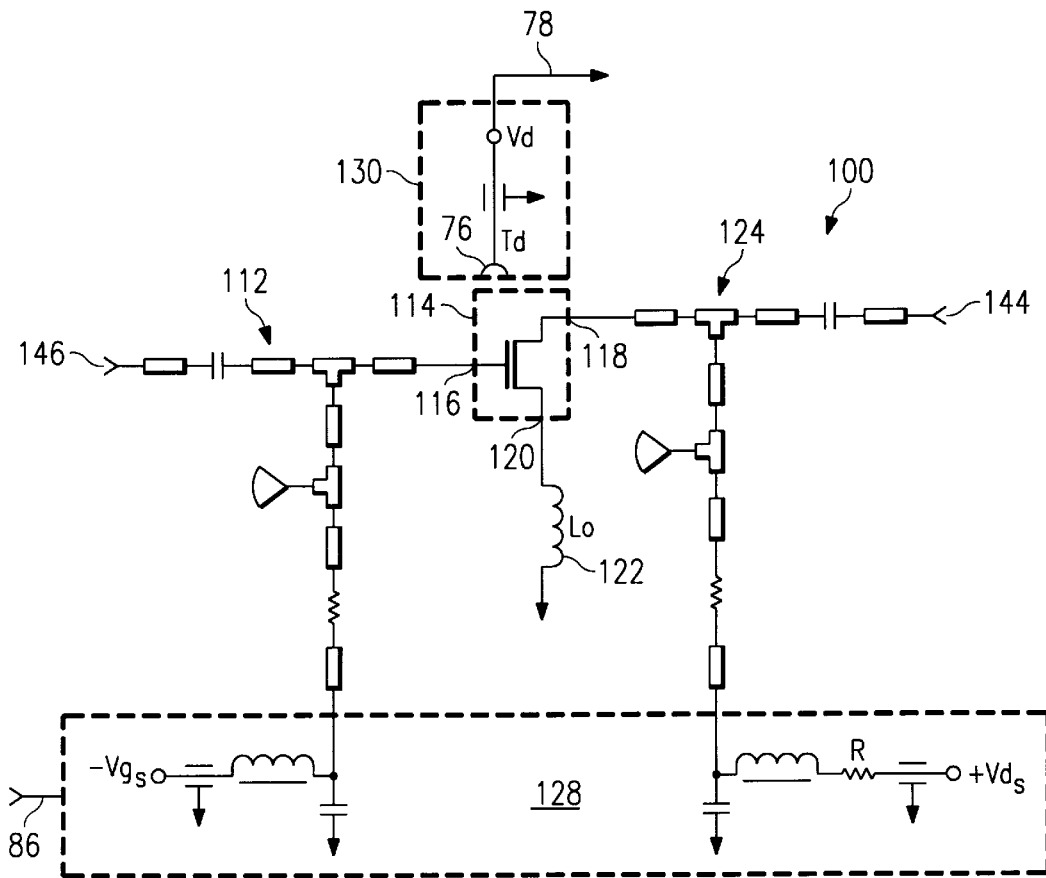

FIG. 8

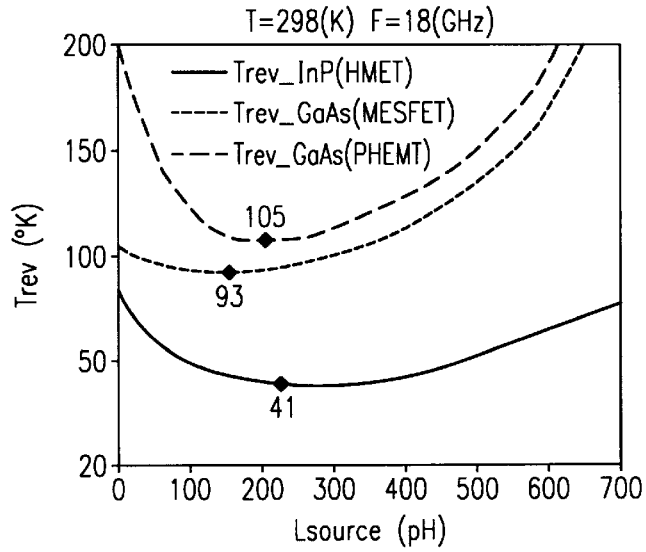

FIG. 9

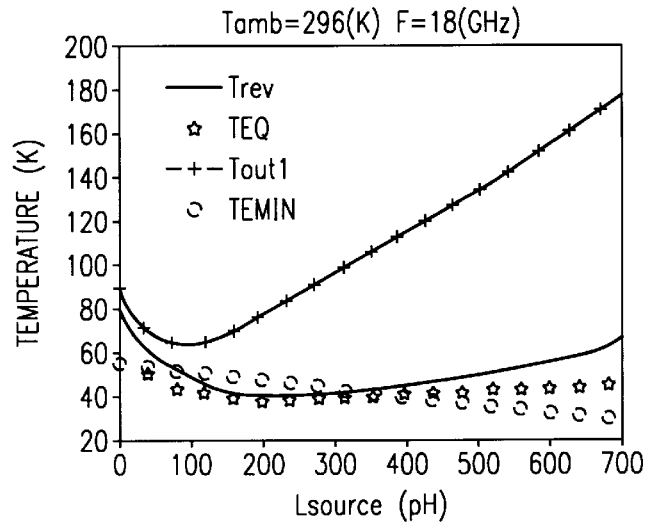

FIG. 10

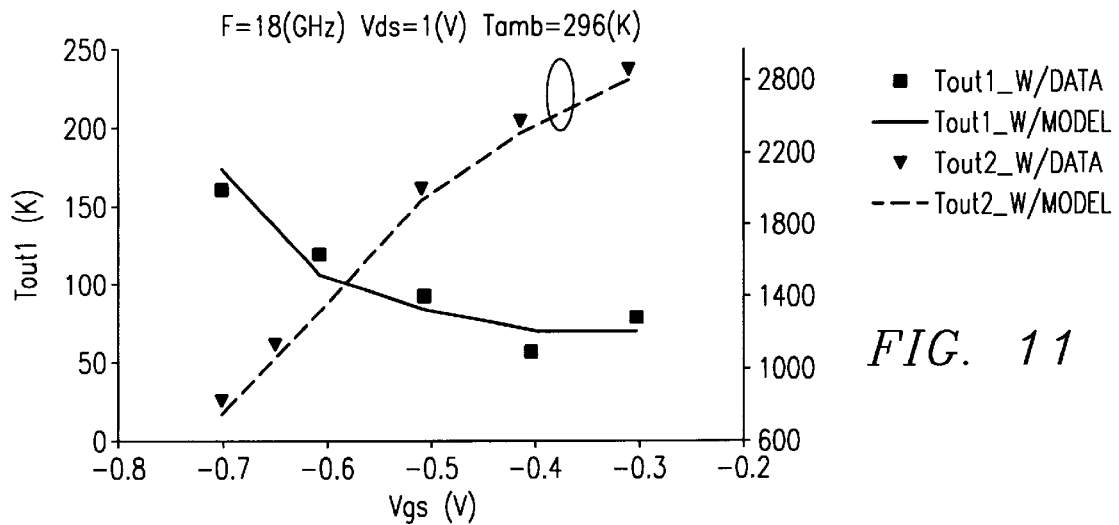

FIG. 11

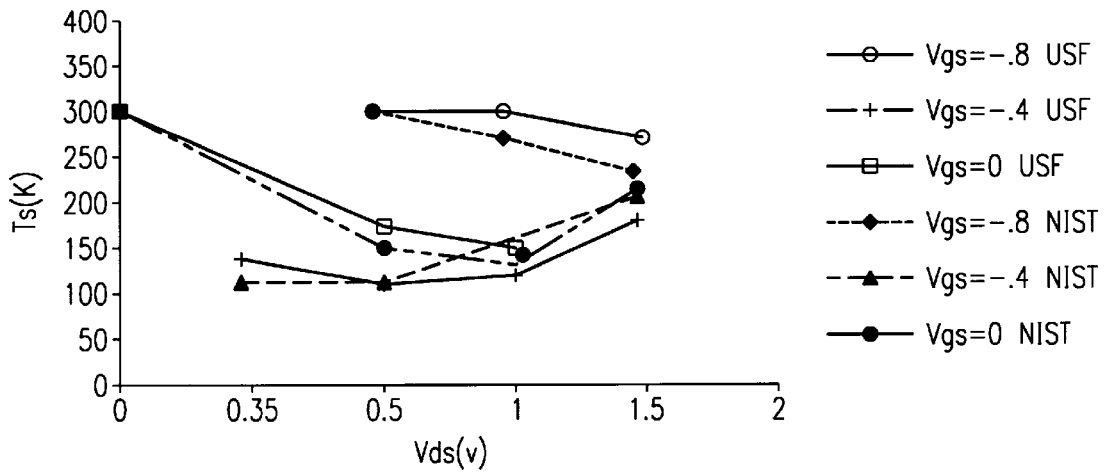

FIG. 12

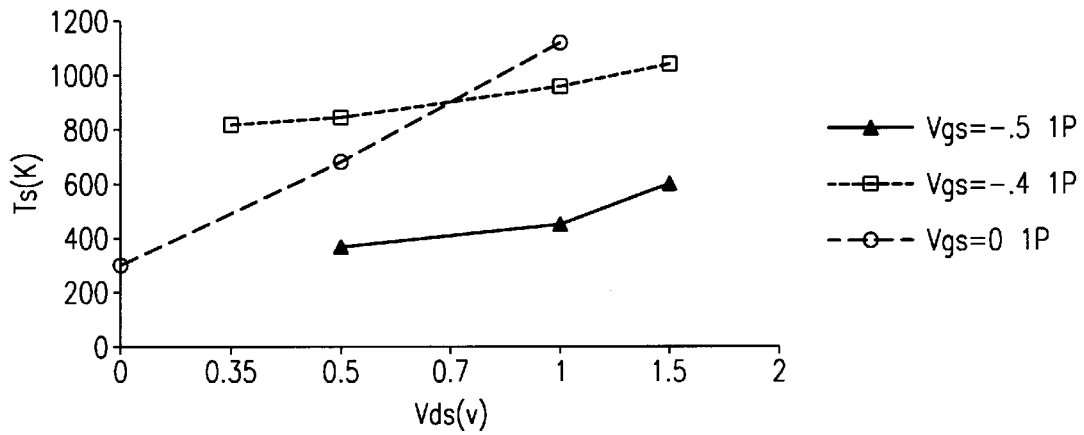

FIG. 13

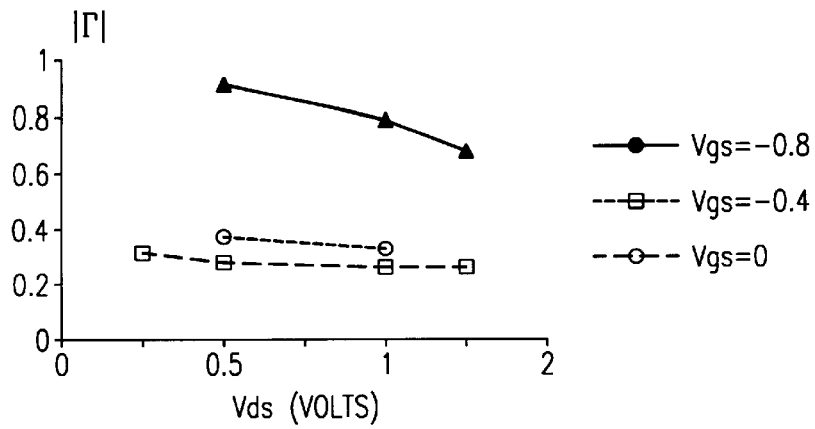

FIG. 14

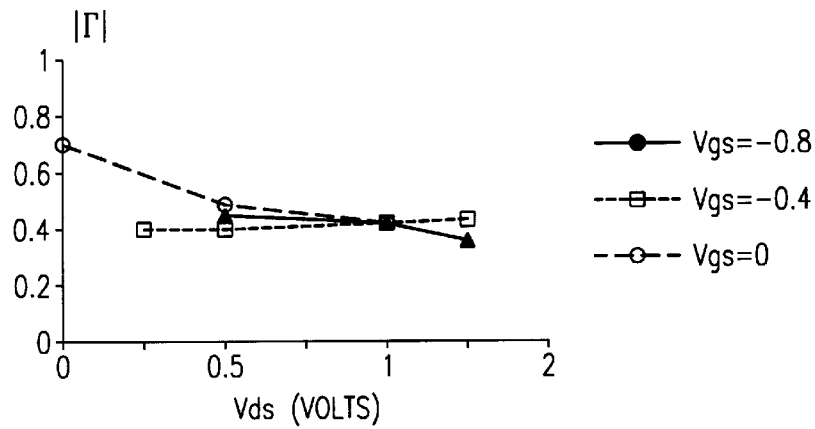

FIG. 15

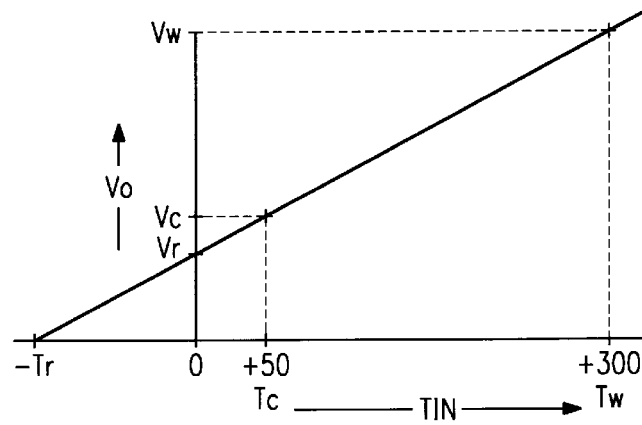

FIG. 16

VARIABLE MICROWAVE COLD/WARM NOISE SOURCE

This application claims the benefit of U.S. Provisional Application Ser. No. 60/032,262 filed on Dec. 3, 1996.

TECHNICAL FIELD OF THE INVENTION

The present invention relates to calibration of a radiometer with reference temperatures from a noise source and, more particularly, to calibration of a radiometer with reference temperatures from an electronically adjustable noise source providing hot thermal radiation temperature from an output port and cold thermal radiation temperature from an input port.

BACKGROUND OF THE INVENTION

Radiometers are used to measure thermal radiation or brightness temperatures emitted from a segment of a remote object. The segment is commonly referred to as a scene and may be a portion of the earth's surface. Like most sophisticated instrumentation, radiometers require periodic calibration to insure accurate measurements. In practice, at least two known calibration temperatures that bound the brightness temperatures of the scene are used to calibrate a radiometer receiver. The lowest and highest calibration temperatures are referred to as cold and hot thermal radiation temperatures, respectively.

Radiometers are generally ground-based, airborne or satellite-based systems that measure brightness temperatures in the mostly cold range of 10° K.–300° K. There are also specialized radiometer applications where an instrument is needed to measure hot brightness temperatures from forest fires and burning dumps. For these applications the radiometer must measure brightness temperatures in the range of 300° K. to greater than 1000° K. The ground-based systems may utilize closed cycle refrigeration such as a sterling cycle cooler with liquid nitrogen or is liquid helium to generate cold thermal radiation temperatures "Tc". The closed cycle refrigeration systems are not considered practical for the satellite-based systems.

Referring to FIGS. 1–3, there are illustrated three traditional satellite-based systems for measuring the brightness temperature "Ta" emitted from a portion of the earth's surface and received by an antenna 36. The brightness temperature "Ta" is then transmitted through an antenna feed 32 on an antenna-earth scene line 12 to a radiometer receiver 16 of the radiometer 150. Currently, satellite-based systems use calibration techniques that are either externally-based (FIGS. 1 and 2) or internally-based (FIG. 3).

Referring to FIG. 1, there is illustrated an externally-based calibration technique known as the sky horn approach. The sky horn approach utilizes a radiometer 150 which includes a first RF switch 10 connected to either the antenna-earth scene line 12 or a calibration line 14 to the radiometer receiver 16. In the calibration line 14 a second RF switch 18 alternately switches between a sky horn 20 and an internal warm load 22. The sky horn 20 outputs the cold space thermal radiation temperature "Tc," approximately 2.7° K., and the internal warm load 22 generates a warm thermal radiation temperature "Tw," approximately 300° K. A precision thermistor 24 in thermal contact with the warm load 22 outputs an electrical hot thermal radiation temperature "Td" that is equivalent to the hot thermal radiation temperature "Tw." The electrical hot thermal radiation temperature "Td" is utilized in the calibration of the radiometer receiver 16.

The sky horn approach is a complex and expensive way to calibrate the radiometer receiver 16. The main problem is that the antenna-earth scene line 12 and calibration line 14 are separate lines, thereby requiring precise knowledge of the RF losses, mismatch losses and physical temperatures of each line to accurately calibrate the radiometer receiver 16. Also, the use of the sky horn 20 adds to the complexity of the calibration, because of possible interference of the sky horn pattern by a spacecraft or contamination caused by the earth or sun.

Referring to FIG. 2, there is illustrated another externally-based calibration technique for satellite-based systems using an antenna scanner 26. The antenna scanner 26 is a mechanical mechanism employed during a calibration mode to alternately couple a reflector plate 28 or an absorption target 30 to respectively feed a cold thermal radiation temperature "Tc" or a warm thermal radiation temperature "Tw" to the antenna feed 32. The antenna feed 32 is connected to the radiometer receiver 16. During an antenna mode when the brightness temperature "Ta" is measured the antenna scanner 26 connects the antenna-earth scene line 12 to the radiometer receiver 16. The antenna scanner 26 does have an advantage over the sky horn approach in that only one RF path is utilized. However, the antenna scanner 26 is complex, bulky and adds significant size and weight to the radiometer 150.

Referring to FIG. 3, there is illustrated an internally-based calibration technique that may be used in a satellite-based system. The internal approach is very similar to the sky horn approach discussed previously and illustrated in FIG. 1. However, the internal technique may utilize a thermoelectric cooler 34 to generate a cold thermal radiation temperature "Tc" of approximately 270° K., instead of the sky horn 20 used in the sky horn approach. However, the warm and cold thermal radiation temperatures "Tc" and "Tw" used in the internal approach may only be 30° K. apart. The 30° K. difference between the cold and warm thermal radiation temperatures "Tc" and "Tw" does not cover the full range of earth brightness temperatures which are approximately 100° K. to 300° K., (exclusive of burning materials) therefore, measurement accuracy of the radiometer receiver 16 will likely degrade below the cold thermal radiation temperature "Tc." Accordingly, there is a need for an adjustable calibration noise source to provide cold to hot thermal radiation temperatures from a waveguide or coaxial port. There is also a need to provide a noise source manufactured using microwave integrated circuit (MIC) and/or monolithic microwave integrated circuit (MMIC) technologies. These and other needs are satisfied by the adjustable calibration noise source of the present invention.

SUMMARY OF THE INVENTION

The present invention is a radiometer calibration system utilizing an electronically adjustable noise source and a method for calibrating a radiometer. The noise source includes a transistor configured as a noise equivalent circuit having a gate port, drain port and source port. A source inductance providing series feedback for the noise source has one end coupled to the source port of the noise equivalent circuit and another end connected to ground. A bias circuit controls the amount of DC bias applied to the noise equivalent model. In order to match the impedances in the noise source, an output impedance matching network is connected to the drain port and an input impedance matching network is connected to the gate port of the noise equivalent model. The output and input impedance networks have an output port and input port, respectively. The noise

source terminates a matched load to the output port while an adjustable cold thermal radiation temperature is generated at the input port. Alternatively, a port switch may be used to terminate a matched load to the input port while an adjustable hot thermal radiation temperature is generated at the output port.

According to the present invention there is provided an adjustable noise source for calibrating ground-based, airborne, or satellite-based radiometers.

Also in accordance with the present invention there is provided a noise source that functions in the millimeter and microwave spectrum.

Further in accordance with the present invention there is provided a noise source implemented as an integrated circuit.

Further in accordance with the present invention there is provided a calibration system having a noise source for measuring the radiometer receiver transfer function or receiver linearity.

Further in accordance with the present invention there is provided a calibration system having a noise source with a built-in-test capability providing noise figure measurements.

In accordance with the present invention there is also provided a radiometer having adjustable calibration time intervals to maximize the measurement of earth scenes.

BRIEF DESCRIPTION OF THE DRAWINGS

A more complete understanding of the invention may be had by reference to the following Detailed Description when taken in conjunction with the accompanying Drawings wherein:

FIG. 1 is a schematic representation of PRIOR ART illustrating a sky horn approach for calibrating a satellite-based radiometer;

FIG. 2 is a schematic representation of PRIOR ART illustrating a calibration technique using an antenna scanner;

FIG. 3 is a schematic representation of PRIOR ART where an internally-based calibration technique uses a thermoelectric cooler;

FIG. 4 is a schematic representation of the present invention illustrating a satellite-based radiometer calibration system incorporating an adjustable noise source;

FIGS. 5A-5D are illustrations of calibration curves for use with the radiometer calibration system of FIG. 4;

FIGS. 6A,6B and 6C are illustrations of calibration and port switch commands respectively transmitted by a microprocessor to a driver and the adjustable noise source illustrated in FIG. 7;

FIG. 7 is a schematic of the adjustable noise source;

FIG. 8 is a schematic of the adjustable noise source (without a port switch, port driver and load) implemented as a microwave integrated circuit;

FIG. 9 is a graph indicating noise temperature performances for three types of FETS, each biased for a minimum noise figure at 18 GHz;

FIG. 10 is a graph comparing input noise temperatures output from an InP HEMT (FET) having various source inductances;

FIG. 11 is a graph of measured and simulated data illustrative of cold and hot thermal radiation temperatures output from the InP HEMT illustrated in FIG. 11;

FIG. 12 is a graph of cold thermal radiation temperatures measured at the InP HEMT operating at 18 GHz;

FIG. 13 is a graph of hot thermal radiation temperatures measured at the FET operating at 18 GHz;

FIG. 14 is a graph illustrating a measured variation of cold noise source (port 1) reflection coefficient magnitude at 18 GHz;

FIG. 15 is a graph illustrating a measured variation of warm noise source (port 2) reflection magnitude at 18 GHz; and

FIG. 16 is a graph illustrating a noise figure measurement of the radiometer receiver.

DETAILED DESCRIPTION OF THE INVENTION

Referring to FIG. 4, wherein like numerals represent like parts throughout the several views, there is disclosed an adjustable noise source **100** for calibration of a radiometer in accordance with the present invention.

Although the noise source **100** will be described incorporated with a radiometer calibration system **150**, those skilled in the art will appreciate that such application is only one of many for utilizing the noise source of the present invention. Accordingly, the described noise source **100** should not be construed in a limiting manner.

A noise source using a FET such as illustrated and described in United States Provisional Application Ser. No. 60/032,290 has warm and cold thermal radiation temperatures output at the gate port of the FET. Robert Roeder and Matthew Smith, two of the inventors of the present invention, are joint inventors of the noise source illustrated and described in the U.S. Provisional Application Ser. No. 60/032,290, which is hereby incorporated into this specification.

Major contributing errors associated with calibrating satellite-based radiometers arise from the following factors: (1) cold calibration brightness temperature; (2) warm calibration brightness temperature; (3) radiometer receiver transfer function; (4) ground retrieval algorithm; and (5) antenna brightness temperature. Each of the major contributing errors must be separately addressed and combined in establishing an overall accuracy scheme for the radiometer calibration system **150**. The errors associated with the cold and warm calibration brightness temperatures and the radiometer receiver transfer function are addressed by the noise source **100**. A detailed description of the noise source **100** will be discussed after describing the interaction of the noise source with the radiometer calibration system **150**.

Referring to FIG. 4, there is illustrated a block diagram of the satellite-based radiometer calibration system **150** incorporating the noise source **100**. The brightness temperature "Ta" emitted from a segment of the earth's surface is received by the antenna reflector **36** and transmitted to the antenna feed **32**. The antenna feed **32** outputs the brightness temperature "Ta" on the antenna-earth scene line **12**. The antenna-earth scene line **12** is connected to a selector switch **62** for switching either the antenna-earth scene line **12** or a calibration line **64** to an input terminal **66** of the radiometer receiver **16**. The calibration line **64** connects the noise source **100** to the radiometer receiver **16**. The selector switch **62** is preferably a low loss RF ferrite switch.

A driver **68** actuates and controls the selector switch **62** according to commands received from a microprocessor **70**. Initially, the microprocessor **70** receives a "test command" signal from an external source (not shown) on line **80**; the test command triggers the calibration sequence.

Referring to FIGS. 4, 6A, 6B and 6C, the microprocessor **70** transmits a command on line **72** to the driver **68** to actuate

either an antenna mode **82** or calibration mode **84** (FIG. 6A). In the antenna mode **82** the selector switch **62** is actuated to connect the antenna-earth scene line **12** to the input terminal **66** of the radiometer receiver **16**. In the calibration mode **84** the selector switch **62** is actuated to connect the calibration line **64** to the input terminal **66** of the radiometer receiver **16**. Selection of the calibration mode at selected time intervals for short durations maximizes measurements of the brightness temperatures “Ta”.

The microprocessor **70** also transmits a port switch command signal **86** (FIG. 6B) on line **74** to the noise source **100**. The noise source **100**, in response to the port switch command signal **86**, alternately outputs a fixed cold thermal radiation temperature “Tc” or a fixed warm thermal radiation temperature “Tw”. The temperature may be stepped from warm to cold as shown in FIG. 6C. The stepped mode is used to measure the radiometer receiver transfer function. Alternating between the warm and cold thermal radiation temperatures “Tc”, “Tw” occurs during the calibration mode **84**. The noise source **100** does not output the cold thermal radiation temperature “Tc” or the warm thermal radiation temperature “Tw” during the antenna mode **82**.

Referring again to FIG. 4, the noise source **100** includes a correction precision thermistor **76** in thermal contact with the noise source and connected to the microprocessor **70** by a line **78**. The correction precision thermistor **76** provides compensation for changes in the physical temperature “Td” of the noise source **100**. A thermal insulation blanket **71** may be provided to encompass the noise source **100**. The compensation, DC bias, and the correction precision thermistor **76** will be discussed in greater detail later.

Prior to using the radiometer calibration system **150**, the noise source **100** is initially calibrated with a laboratory radiometer (not shown). During the initial calibration of the radiometer calibration system **150** there is generated a series of reference calibration curves which are stored in the microprocessor **70**. The calibration curves are accessed by the microprocessor **70** during the calibration mode **84** to adjust the uncorrected output voltage from the radiometer receiver **16** on line **98** to output a corrected output voltage on line **99**.

Referring to FIGS. 5A, 5B, 5C and 5D, the calibration curves include a precision thermistor calibration curve **88**, a noise source radiation temperature drift curve **90**, a radiometer calibration curve **92** and a corrected radiometer calibration curve **94**. The calibration curves illustrate the calibration procedure based on using the two known calibration temperatures “Tc” and “Tw”.

The precision thermistor curve **88** (FIG. 5A) illustrates the change in the voltage “Vd” versus the physical temperature “Td” of the noise source **100** sensed by the thermistor **76** and applied to the microprocessor **70** along signal line **78**. “Vd” is a calibrated thermistor output voltage corresponding to the known physical temperature “Td.”

The noise source radiation temperature drift curve **90** (FIG. 5B) on the line **64** and radiometer calibration curve **92** (FIG. 5C) on the line **98** are combined into the corrected radiometer calibration curve **94** (FIG. 5D) The corrected radiometer calibration curve **94** represents the amount of correction required of the uncorrected output voltage generated by the radiometer receiver **16** on line **98** and input to the microprocessor **70**. The radiometer calibration curve **92** (FIG. 5C) illustrates the radiometer calibration performance during the calibration mode **84**. The uncertainty is due to the variation in the physical temperature “Td” of the noise source **100**. The microprocessor **70** utilizing data repre-

sented by the precision thermistor curve **88** adjusts the uncorrected voltage output on line **98** to generate a corrected voltage on line **99**. The corrected voltage output represents the correct output by taking into consideration the physical temperature “Td” of the noise source **100**. The shift in the calibration curves **88**, **90**, **92** and **94** have been exaggerated to illustrate the correction procedures of the radiometer calibration system **150**. Furthermore, data represented by the calibration curves **88**, **90**, **92**, and **94** is also utilized to adjust the output signal of the radiometer receiver **16** when operating in the antenna mode **82**.

Referring FIG. 7, there is illustrated a schematic of the adjustable noise source **100**. The noise source **100** includes a field effect transistor (FET) configured as a noise equivalent model **114** and having a gate port **116**, a drain port **118** and a source port **120**. The noise equivalent model **114** is a microwave active circuit designed to generate noise temperatures such as warm and cold thermal radiation temperatures “Tw1” and “Tc” when DC bias is applied.

The term “noise temperature” is an expression for the noise power spectral density at a specified f frequency and is derived from Planck’s blackbody formula. The average energy of an oscillator at a temperature T is:

$$\langle \epsilon \rangle = \frac{hf}{\exp(hf/kT) - 1} \quad (1)$$

where f is the frequency; h is Planck’s constant; and k is the thermal conductivity. At high temperatures and low frequencies $\langle \epsilon \rangle$ approaches kT so the power in a bandwidth B will be $P=kTB$ (Nyquist’s formula). A quantity $\phi=P/kB$ is taken as a convenient unit of thermal noise power spectral density and is referred to as “noise temperature.”

The noise source **100** includes a source inductance **122** with one end coupled to the source port **120** of the noise equivalent model **114** and another end connected to ground. The source inductance **122** provides series feedback for the noise source **100**, where the source inductance **122** is typically in the range of 20–700 pH.

A bias circuit **128** generates the DC bias that is applied to the noise source **100**, during the calibration mode **84**. The bias circuit **128** generates the voltage “Vgs” **140** (voltage across the gate port **116** and the source port **120**) and the voltage “Vds” **142** (voltage across the drain port **118** and the source port **120**). The microprocessor **70** adjusts the magnitude of the DC bias to change the values of the cold and hot thermal radiation temperatures “Tc” and “Tw”. More particularly, the DC bias corresponds to the port switch command signal on line **74** transmitted from the microprocessor **70** (FIG. 4).

A stabilizing compensation circuit **130** in contact with the noise equivalent model **114** and connected to the microprocessor **70** (FIG. 4) provides further control of the DC bias. The stabilizing circuit **130** includes the precision thermistor **76** and measures the physical temperature “Td” of the noise source **100**. When the stabilizing compensation circuit **130** is not used fluctuations in the physical temperature “Td” of the noise source **100** may adversely effect the performance of the noise source.

An output matching impedance network **124** includes an output port **144** from which the warm thermal radiation temperature “Tw” is outputted. The output matching impedance network **124** further includes a plurality of output transmission lines and/or lumped elements (FIG. 8) configured and sized to match the impedances of the output port **144** and the drain port **118** of the noise equivalent circuit

114. The output matching network 124 has one end connected to the drain Port 118. The plurality of output transmission lines and/or lumped elements may be manufactured on an Al₂O₃ substrate of approximately 0.015" thick for frequencies up to about 35 GHz.

An input matching impedance network 112 includes an input port 146 from which the cold thermal radiation temperature "Tc" is outputted. The input matching network 112 further includes a plurality of input transmission lines and/or lumped elements (FIG. 8) configured and sized to match the impedances of the input port 146 and the gate port 116 of the noise equivalent circuit 114. The input matching impedance network 112 has one end connected to the gate port 116 of the noise equivalent model 114. The plurality of input transmission lines and/or lumped elements may be manufactured on an Al₂O₃ substrate approximately 0.015" thick.

A port driver 151 actuates and controls a port switch 148 according to a port switch command received from the microprocessor 70. The port driver 151 preferably configured with low loss RF ferrite switches. The port switch 148 has a plurality of contacts connecting output port 144 and input port 146, to the calibration line 64 (FIG. 4).

The port switch 148 selects either the cold thermal radiation temperature "Tc" or the hot thermal radiation temperature "Tw." The contacts of the port switch 148 are configured in a predetermined manner such that a matched load 152 terminates the input port 146 when the calibration line 64 connects to the output port 144, or a matched load 153 terminates the output port 144 when the calibration line 64 connects to the input port 146.

The hot thermal radiation temperature "Tw" exits the output port 144 when the matched load 152 terminates the input port 146, and a cold thermal radiation temperature "Tc" exits the input port 146 when the matched load 153 terminates the output port 144. The two matched loads 152 and 153 have one end connected to the ground and the other end connected to either the output port 144 or the input port 146. The typical noise temperatures generated by the noise source 100 have a range of less than 100° K. to greater than 2600° K.

Referring to FIG. 8, there is illustrated a schematic of an adjustable noise source implemented as a microwave integrated circuit. The microwave integrated circuit utilizes either microwave integrated circuit (MIC) or monolithic microwave integrated circuit (MMIC) technologies. The noise source 100 may be designed to operate in the microwave and millimeter wave spectrum having an operation frequency of less than 2 GHz to greater than 90 GHz.

Referring to FIG. 9, a series of graphs illustrate noise temperature performances for three types of FETs, each biased for minimum noise figure at 18 GHz. The FET types include a 0.25 μm GaAs MESFET, a 0.25 μm GaAs PHEMT and a 0.15 μm InP HEMT. The FETs were enabled by noise circuit models and implemented in HP-EESOF's Libra (TM). "Trev" represents noise power exiting the input port of a two-port terminated in a reflection-less load held at 0° K.

"Trev", also referred to as reverse available noise, may be used to predict a source temperature "Ts" (FIG. 7) which is either the cold or warm thermal radiation temperature "Tc" and "Tw." The source temperature "Ts" is indicative of the cold or warm thermal radiation temperature "Tc" and "Tw" when the reverse available noise "Trev" is added to an ambient temperature noise of the opposite port termination transformed through the noise equivalent model 114 using the appropriate forward or reverse power gain. The source temperature "Ts" so calculated may be referred to as port 1 source temperature "Tout1" and port 2 source temperature "Tout2".

Referring to FIG. 10, there is illustrated a graph comparing input noise temperatures output from an InP HEMT (FET) having various source inductances 122. The graph also includes measurements for "Temin" the effective minimum noise temperature defined as T_{emin}=T_o(F_{min}-1). The graph also indicates "Teq" the equivalent noise temperature of the short circuit noise current in the input port 146 having a resistance of 50 Ω.

FIG. 11 is a graph illustrative of measured and simulated data of cold "Tout1" and warm "Tout2" thermal radiation temperatures "Tc" and "Tw" output from the InP HEMT. In the graph the source temperature "Ts" is a function of the voltage "Vgs" 140 where "Vds" 142 equals one volt and source inductance 122 equals 0.24 nH.

FIG. 12 is a graph of cold thermal radiation temperatures "Tc" measured from the InP HEMT operating at 18 GHz. A portion of the measurements were made at the National Institute of Standards and Technology (NIST) using an 18–26 GHz substitution radiometer, referenced to a cryogenic waveguide noise standard. The remaining measurements were taken by using the noise power measurement mode of a 0.01–18 GHz HP8970B/HP8971B noise figure measurement system. The remaining measurements were referenced to a HP346B solid-state diode.

FIG. 13 is a graph of warm thermal radiation temperatures measured at 18 GHz, from the output port with the input terminated in a 50 OM load.

FIG. 14 is a graph illustrating a measured variation of cold noise source (port 1) reflection coefficient magnitude. The measured variation may necessitate the use of a circulator for some applications, and is responsible for some of the differences between the temperature data illustrated in FIG. 12. However, the reflection coefficient does show minimal variation with bias in the intended operation region.

FIG. 15 is a graph illustrating a measured variation of hot noise source (port 2) reflection magnitude.

Referring to FIG. 16 there is a graph illustrating a noise figure measurement of the radiometer receiver 16. Noise figure measurement is the process of quantitatively determining the ratio of the total noise power per unit bandwidth at the output of the noise source 100 to the portion of the noise power due to the input termination, at the standard temperature of 290° K. The noise figure (F) equation may be represented by the following equation:

$$F = T_r / T_o + 1 \quad (2)$$

where "Tr" is the receiver noise temperature and "To" represents the temperature of the radiometer receiver 16. "To" is measured using a receiver precision thermistor (not shown) mounted on RF components in the radiometer receiver 16.

The following equations are derived by referring to FIG. 7 and are relevant in calculating the noise figure measurement utilizing a linear radiometer receiver 16:

For the linear radiometer receiver—

$$\frac{V_o - V_c}{T_{in} - T_c} = \frac{V_w - V_c}{T_w - T_c} \quad (3)$$

$$T_{in} = T_c \text{ or } T_w \text{ applied to the radiometer receiver} \quad (4)$$

$$\text{For } T_{in} = 0$$

$$V_r = V_c = T_c \left[\frac{V_w - V_c}{T_w - T_c} \right]; \text{ and} \quad (5)$$

-continued

$$Tr = Vc \left[\frac{Tw - Tc}{Vw - Vc} \right] - Tc \quad (6)$$

The noise figure is expressed by:

$$F = Tr / To + 1 \quad (\text{where } To \cong 290^\circ \text{ (ambient)}) \quad (7)$$

where "Vc," "Vr," and "Vw" are the radiometer output voltages corresponding to "Tc," "Tr" and "Tw," respectively.

While the present invention has been described with reference to the illustrated embodiment, it is not intended to limit the invention, on the contrary, it is intended to cover such alternatives, modifications and equivalents as may be included in the spirit and scope of the invention as defined in the following claims.

We claim:

1. An adjustable noise source, for calibration of a radiometer, comprising:

a noise equivalent circuit having a first port, a second port and a third port;

a source inductance providing series feedback and having one terminal coupled to the third port of the noise equivalent circuit and another terminal connected to ground;

an output impedance matching network terminated at the second port of the noise equivalent circuit, said output impedance matching network includes an output port;

an input impedance matching network connected to the first port of the noise equivalent circuit, said input impedance matching network includes an input port;

a bias circuit for applying a DC bias to the output impedance matching network and the input impedance matching network;

a matched load having a first terminal connected to the ground; and

a port switch having a first position for connecting a second terminal of the matched load to the input port and for connecting a calibration line to the output port, and a second position for connecting the second terminal of the matched load to the output port and for connecting the calibration line to the input port to generate a warm thermal radiation temperature output from the output port when the matched load terminates the input port and generate a cold thermal radiation temperature output from the input port when the matched load terminates the output port.

2. The noise source in accordance with claim 1 further comprising a microprocessor connected to the bias circuit, said microprocessor generating control signals to adjust the DC bias to establish the cold thermal radiation temperature output and the warm thermal radiation temperature output.

3. The noise source in accordance with claim 2 further comprising a stabilizing compensation circuit in thermal contact with the noise equivalent circuit and connected to the microprocessor to provide temperature related control of the DC bias.

4. The noise source in accordance with claim 3 wherein the stabilizing compensation circuit further comprises a precision thermistor in thermal contact with the noise equivalent circuit.

5. The noise source in accordance with claim 1 wherein the noise equivalent circuit comprises a microwave active FET having DC bias and temperature dependent small signal parameters.

6. The noise source in accordance with claim 5 wherein the noise equivalent circuit selectively operates at frequencies from about 2 GHz to 90 GHz.

7. The noise source in accordance with claim 1 wherein the cold thermal radiation temperature output and the warm thermal radiation temperature output encompass a range of about 100° K. to 2600° K.

8. A radiometer comprising:

a radiometer receiver;

a switch connected to said receiver for selecting between an antenna mode and a calibration mode, the antenna mode enabling a brightness temperature received from an antenna to be applied to the radiometer receiver;

a driver coupled to said switch for controlling the operation of the switch;

an adjustable noise source connected to the radiometer receiver through said switch when in the calibration mode, said noise source comprising:

a noise equivalent circuit having a first port, a second port, and a third port;

a source inductance providing series feedback having one terminal coupled to the third port of the noise equivalent circuit and another terminal connected to ground;

an output impedance matching network terminated at the second port of the noise equivalent circuit, said output impedance matching network includes an output port;

an input impedance matching network connected to the first port of the noise equivalent circuit, said input impedance matching network includes an input port;

a bias circuit for applying a DC bias to the output impedance matching network and the input impedance matching network;

a matched load having a first terminal connected to ground; and

a port switch having a first position for connecting a second terminal of the matched load to the input port and for connecting a calibration line to the output port, and having a second position for connecting the second terminal of the matched load to the output port and for connecting the calibration line to the input port to generate a warm thermal radiation temperature output from the output port when the matched load terminates the input port and generate a cold thermal radiation temperature output from the input port when the matched load terminates the output port; and

a microprocessor coupled to the radiometer receiver, said noise source and said driver for correcting the output of said radiometer receiver.

9. The radiometer in accordance with claim 8 wherein the microprocessor generates a port switch command controlling the port switch of the noise source to alternate between the cold thermal radiation temperature output and the warm thermal radiation temperature output.

10. The radiometer in accordance with claim 8 wherein the microprocessor comprises a memory for storing calibration curve data, said microprocessor responds to calibration curve signals from the noise source and the stored calibration curve data to correct voltage outputs from the radiometer receiver.

11. The radiometer in accordance with claim 8 wherein said noise source further comprises a thermistor in thermal contact with the noise source, said thermistor generating a signal to the microprocessor corresponding to a physical temperature of the noise source.

12. The radiometer in accordance with claim 11 wherein said microprocessor further comprises a memory storing a plurality of reference curves for correcting the voltage output from the radiometer receiver.

13. A solid state noise source providing a warm thermal radiation temperature and a cold thermal radiation temperature for calibration of a radiometer, comprising:

- a FET microwave active noise equivalent circuit having a gate port, a drain port and a source port;
- a feedback network coupled to the source port of the FET and to ground for providing a series feedback;
- an output impedance matching network terminated to the drain port of the FET, said output impedance matching network includes an output port;
- an input impedance matching network connected to the gate port of the FET, said input impedance matching network includes an input port;
- a matched load having a first terminal connected to ground;
- a biasing network coupled to the output matching network and the input matching network; and
- a port switch having a first position for connecting a second terminal of the matched load to the input port and for connecting a calibration line to the output port, and having a second position for connecting the second terminal of the matched load to the output port and for connecting the calibration line to the input port, to generate a warm thermal radiation temperature output from the output port when the matched load terminates the input port and generate a cold thermal radiation temperature output from the input port when the matched load terminates the output port.

14. The solid state noise source in accordance with claim **13** wherein the biasing network further comprises a microprocessor for adjusting the DC bias to control the magnitude of the warm thermal radiation temperature output and the cold thermal radiation temperature output.

15. The solid state noise source in accordance with claim **14** further comprising a stabilizing circuit coupled to the microprocessor for compensating and controlling the DC bias.

16. The solid state noise source in accordance with claim **15** wherein the stabilizing circuit comprises a thermistor in thermal contact with the FET.

17. The solid state noise source in accordance with claim **13** wherein the FET selectively operates from about 2 GHz to 90 GHz.

18. An adjustable noise source comprising:

- a noise equivalent circuit having a first port, a second port and a third port;
- a series feedback having one terminal coupled to the third port of the noise equivalent circuit and another terminal connected to ground;
- an output impedance network terminated at the second port of the noise equivalent circuit, said output impedance network includes an input port;
- an input impedance network connected to the first port of the noise equivalent circuit, said input impedance network includes an input port;
- a bias circuit for applying a DC bias to the output impedance network and the input impedance network;
- a load having a first terminal connected to the ground; and
- a port switch having a first position for connecting a second terminal of the load to the input port and for connecting a calibration line to the output port, and a second position for connecting the second terminal of the load to the output port and for connecting the calibration line to the input port.

19. The noise source in accordance with claim **18** further comprising a microprocessor connected to the bias circuit, said microprocessor generating control signals to adjust the DC bias.

20. The noise source in accordance with claim **19** further comprising a stabilizing compensation circuit in thermal contact with the noise equivalent circuit and connected to the microprocessor to provide temperature related control of the DC bias.

21. The noise source in accordance with claim **20** wherein the stabilizing compensation circuit further comprises a precision thermistor in thermal contact with the noise equivalent circuit.

22. The noise source in accordance with claim **18** wherein the noise equivalent circuit comprises a microwave active FET having DC bias and temperature dependent small signal parameters.

* * * * *

UNITED STATES PATENT AND TRADEMARK OFFICE
CERTIFICATE OF CORRECTION

PATENT NO. : 6,217,210 B1
DATED : April 17, 2001
INVENTOR(S) : Robert S. Roeder, et al.

Page 1 of 1

It is certified that error appears in the above-identified patent and that said Letters Patent is hereby corrected as shown below:

Column 6,

Line 29, after "frequency;", delete "his", and insert -- h is --.

Column 11,

Line 1, after "A", delete "sold", and insert -- solid --.

Line 30, after "The", delete "sold", and insert -- solid --.

Line 36, after "The", delete "sold", and insert -- solid --.

Signed and Sealed this

Eighteenth Day of September, 2001

Attest:

Nicholas P. Godici

Attesting Officer

NICHOLAS P. GODICI
Acting Director of the United States Patent and Trademark Office