

10-24-2008

## Seepage Rates in Closed Basins

Volha Martysevich  
*University of South Florida*

Follow this and additional works at: <https://digitalcommons.usf.edu/etd>



Part of the [American Studies Commons](#)

---

### Scholar Commons Citation

Martysevich, Volha, "Seepage Rates in Closed Basins" (2008). *USF Tampa Graduate Theses and Dissertations*.

<https://digitalcommons.usf.edu/etd/381>

This Thesis is brought to you for free and open access by the USF Graduate Theses and Dissertations at Digital Commons @ University of South Florida. It has been accepted for inclusion in USF Tampa Graduate Theses and Dissertations by an authorized administrator of Digital Commons @ University of South Florida. For more information, please contact [digitalcommons@usf.edu](mailto:digitalcommons@usf.edu).

# Seepage Rates in Closed Basins

by

Volha Martysevich

A thesis submitted in partial fulfillment  
of the requirements for the degree of  
Master of Science in Environmental Engineering  
Department of Civil and Environmental Engineering  
College of Engineering  
University of South Florida

Date of Approval:  
October 24, 2008

Major Professor: Mahmood H. Nachabe, Ph.D.  
Mark Stewart, Ph.D.  
Junshan Su, Ph.D.

Keywords: urban drainage, recharge, water balance, karst, deep percolation

© Copyright 2008, Volha Martysevich

## **ACKNOWLEDGEMENTS**

I would like to thank the Public Works Department of Hillsborough County for providing support for the project, my advisor Dr. Mahmood Nachabe for all the guidance in the process of my research, and Jeff Vomacka for access to the weather station data and technical help with the project equipment.

## TABLE OF CONTENTS

LIST OF TABLES.....	iii
LIST OF FIGURES .....	iv
ABSTRACT.....	vi
CHAPTER ONE INTRODUCTION.....	1
1.1 Background.....	1
1.2 Open water.....	3
1.3 Subsurface water.....	8
CHAPTER TWO MATERIALS AND METHODS .....	10
2.1 Sites.....	10
2.2 Instrumentation .....	17
2.3 Data collection and processing .....	20
2.4 Methods to calculate seepage rates between a surficial aquifer and a deep aquifer.....	21
2.5 Methods to calculate seepage rates between a lake and an aquifer .....	24
CHAPTER THREE RESULTS .....	29
3.1 Botanical Gardens.....	29
3.2 Lake Park .....	32
3.3 Lake Wimauma.....	37

3.4 Post office .....	40
3.5 Sinkhole .....	42
CHAPTER FOUR CONCLUSION.....	44
REFERENCES .....	46

## LIST OF TABLES

Table 1	Instrumented sites. ....	10
---------	--------------------------	----

## LIST OF FIGURES

Figure 1	Site 1 satellite map (Google Earth). .....	11
Figure 2	Active pump locations (marked with stars) in Lake Park (provided by Tampa Bay Water).....	12
Figure 3	Site 2 satellite map (Google Earth). .....	13
Figure 4	Soil layers and well depths (cross-section) at Site 3. ....	14
Figure 5	Site 3 satellite map (Google Earth). .....	15
Figure 6	Site 4 satellite map (Google Earth). .....	16
Figure 7	Soil layers and well depths (cross-section) at Site 4. ....	16
Figure 8	Site 5 satellite map (Google Earth). .....	17
Figure 9	Pressure sensitive transducer.....	18
Figure 10	Location of the weather station relative to the water level monitoring sites (Google Earth). .....	19
Figure 11	Weather station.....	19
Figure 12	Unfiltered vs. filtered data.....	20
Figure 13	Diagram explaining variables of the mass balance method for calculating seepage into and out of a surficial aquifer.....	22
Figure 14	Two-wells diagram showing variables used in Darcy's Law. ....	23
Figure 15	Diurnal fluctuations of the water level at Botanical Gardens.....	29

Figure 16	Botanical Gardens: correlation between time since precipitation and seepage and stage.....	31
Figure 17	Botanical Gardens: seepage as a function of lake stage.....	32
Figure 18	Impact of pumping on seepage rate.....	33
Figure 19	Lake Park: correlation between (a) the time since the preceding precipitation event and seepage and stage, and (b) seepage and lake stage.....	35
Figure 20	Lake Park: correlation between seepage during the day following the rain event and the magnitude of the event.....	36
Figure 21	Diagram of the response of seepage to rain events in lakes receiving (a) large and (b) moderate amounts of runoff.....	37
Figure 22	Lake Wimauma: correlation between (a) the time since the preceding precipitation event and seepage and stage, and (b) seepage and lake stage.....	39
Figure 23	Well hydrographs for the post office site.....	41
Figure 24	Well hydrographs for the sinkhole site.....	43



# SEEPAGE RATES IN CLOSED BASINS

Volha Martysevich

## ABSTRACT

Seepage is an important component of the water budget in closed basins that do not have surface water drainage features. In the shallow water table environment of Florida, internal drainage of soil controls flooding. With the recent rapid population growth and urban development in the state, a simple, field-based method is needed to estimate seepage rates. In this study five locations in Hillsborough County, Florida, were instrumented with wells with pressure transducers measuring water level fluctuations at 1 minute resolution. For closed basins with lakes, evaporation (E) rates were determined using data from a weather station and Penman-Monteith FAO56 method, and then seepage rates were calculated from a water budget. Seepage rates varied greatly depending on conditions specific to the site. The seepage rates found for the three surface water sites in this study were 1.1 cm/d for a retention pond surrounded with dense vegetation, 0.5-0.8 cm/d for a natural lake located close to a groundwater pumping site, and 0.4 cm/d for another natural lake with no groundwater pumping in the proximity. Two methods to estimate seepage rates into semi-confined aquifers were compared: (a) mass balance approach and (b) Darcy's equation. At one of the sites the rate was 0.1 cm/d, and at the other site (sinkhole) it ranged between 0.8 cm/d during the wet season

and 0.2 cm/d during the dry season when the head difference between the surficial and Floridan aquifers became smaller. The results of the study indicate that simple and relatively inexpensive field methods can estimate seepage within a narrow range and give reasonable seepage predictions that can be used in flood modeling. The obtained values indicate that seepage does not provide adequate drainage relief in closed basins. Another important finding is the magnitude of the local recharge to the Floridan aquifer. Further sensitivity studies on hydrological models that use seepage as one of the inputs may indicate that lower data collection resolution or simpler ET estimation methods are acceptable.

# CHAPTER ONE

## INTRODUCTION

### 1.1 Background

Closed basins are of special interest to hydrologists and engineers because the topography prevents excess precipitation collected in the catchment from exiting as runoff in streamflow. After a storm, runoff outflow is one of the major sink terms in the water budget equation and is normally higher in magnitude than other sink terms: evapotranspiration (ET) and seepage. With the surface runoff outflow term eliminated, internal drainage via the subsurface becomes very important in estimating the risk of flooding for the closed basin.

This study is particularly relevant to Florida where sinkholes, formed as a result of the dissolution of the underlying calcium rock, produced many small-scale closed basins creating karst topography. Despite the prevalence of karst terrain in Florida and other parts of the world, very little research has been done to understand the hydrology of closed basins. In Florida with the water table close to the land surface and an average yearly precipitation of about 1.3 m, most of which happens during the relatively short rainy season, seepage gains increasing significance. Although the infiltrating capacity of the soil plays a major role at the initial stages of the precipitation event, as time

progresses internal drainage gains importance in preventing flooding by freeing up storage in the upper soil layers to absorb precipitation from the rain events that would follow.

In Florida a surficial aquifer occupies the upper sandy soil layers and is responsible for the shallow water table. It is underlain by water bearing limestone known as the Floridan aquifer or deep aquifer. The surficial aquifer drains into the deep aquifer freeing up storage within the upper soil layers. In some areas where depressions in the ground are particularly deep, the shallow water table intersects the land surface resulting in the formation of lakes. Because the water table in the surficial aquifer is very dynamic, many of these lakes are recharge lakes as opposed to more common discharge lakes. This study considers cases of lake-groundwater interaction and of surficial-deep aquifer interaction in a karst environment. It also looks into the behavior of variable saturation areas.

The findings of the study are applicable to many engineering design problems. One of the applications is flooding mitigation in the context of urban design. In recent years, the population growth in Florida gave rise to increasing urban development of land. Land use is known to be one of the determining factors in the distribution of the water budget components such as runoff, infiltration, seepage, and ET. Within a watershed, the precipitation that is not intercepted by vegetation and is in excess of the land infiltration capacity becomes runoff and either exits the larger basin with the streamflow or accumulates in smaller closed basins within the watershed. Water trapped

in the low lying closed basins seeps into the ground recharging the groundwater. The rate of seepage determines the likelihood of flood in the area. Land urbanization decreases the ability of the ground to absorb precipitation, and as a result the runoff increases. Seepage rates in closed basins help to determine whether development of the adjacent lands is acceptable. In order to optimize urbanization, methods of calculating accurate seepage rates in closed basins are necessary. Flood zone delineation could also benefit from this study as the seepage rate within a closed basin is a significant factor in determining the chance of flooding even in the areas with a relatively deep water table.

## **1.2 Open water**

Seepage rates between the lakes and underlying aquifers can be measured directly, inferred from the water balance equation after other components of the water balance are measured or calculated, or simulated numerically by using one of the established models. Equipment that measures seepage directly such as lysimeters and seepage meters can be costly and difficult to install. Besides, seepage velocities through the bottom of the lake can exhibit high spatial heterogeneity (McBride and Pfannkuch, 1975). As a result, the measurements taken by a seepage meter at a point may not extrapolate to sites other than where data was collected. Tracer analysis is another way to measure seepage and has been reported to be reliable for the estimation of point flow rates (Divine and McDonnell, 2005). But just as values obtained with seepage meters, the results of tracer studies at a few points may not be representative of the overall seepage from or into the lake. In order for the tracer studies to produce reliable results, many data points have to be observed which can make the study labor intensive. Besides, the

variation in performance of different tracers has been reported for analysis of surface water /ground water interactions in a closed basin. The study of seepage in a closed basin lake by LeBaugh et al. (1997) proved to be inconclusive due to different tracers producing results that did not agree with each other. This emphasized the necessity of using hydrologic methods in analysis of lake/aquifer interactions. Numerical simulations for calculating seepage are often idealized and do not represent real field conditions. This study uses a field data interpretation to infer seepage rates from the water balance equation. This method is most suitable for the purpose and the scope of the study since it provides an overall net seepage value as opposed to point measurements. The water balance based methodology selected for this study has yet another advantage. It does not require knowledge of spatial distribution of lakebed geology and values of hydraulic conductivity which can be difficult to estimate.

Several researchers used water balance to estimate seepage for different applications and in different environments. For example, Craig (2006) calculated evapotranspiration (ET) using PM FAO56 and used it in place of evaporation (E) in a water balance study of seepage loss from drinking water storage reservoirs in Australia. This study will focus on the application of the methodology to three surface water environments representative of Florida.

The water balance equation is as follows:

$$\Delta WL = P + R + Q_{in} - Q_{out} - S - E$$

Where  $\Delta WL$  is the change in water level,  $P$  is precipitation,  $R$  is surface runoff,  $Q_{in}$  is sources of surface flow into the lake,  $Q_{out}$  is sinks (surface flow out of the lake),  $S$  is seepage, and  $E$  is evaporation. When no natural (e.g. streams flowing into or out of the lake) or artificial (e.g. pumps or hydraulic structures allowing flow in or out of the lake) sinks or sources are present, the water balance components are  $E$ ,  $P$ ,  $R$ ,  $S$ , and  $\Delta WL$ . During the periods of no rain and consequently no runoff, the water balance equation reduces to three terms:  $E$ ,  $S$ , and  $\Delta WL$ .  $E$  can be calculated by one of the multiple methods developed for this purpose. The change in water level is recorded by the equipment, leaving seepage rate as the only unknown.

In order to accurately estimate seepage rates, a reliable method of estimating  $E$  is highly important. One of the most elementary methods of estimating  $E$  is measuring pan  $E$ . Many studies that used pans to estimate reference ET proved that  $E$  obtained by this method has a high uncertainty (Chiew et al., 1995; Grismer et al., 2002; Craig, 2006). Moreover, pan  $E$  cannot be directly related to open water body  $E$ . Wind blowing across an open lake can develop a significantly higher speed than the wind speed on land where the evaporation pan is located. This prompts higher  $E$  from the water body than the one estimated from the pan measurement. Another factor to consider is the so called “oasis effect” when air around the pan is much drier than the air over the lake. As a result of this phenomenon, vapor molecules leave the pan more readily because of the water vapor gradient created by the local air moisture distribution. These factors make pan method of measuring  $E$  from open water inaccurate and suitable only for rough estimations.

One of the earliest methods of calculating rather than measuring E was developed by Dalton (1798). By observing pan E, he established that the deficit of water vapor in the atmosphere is the driving force of E. The process is further facilitated by the presence of wind. However, E is prominent even in very humid and calm climates similar to the one in Florida. This led scientists to believe that there are other variables contributing to the rate of E. Penman (1948) established that the rate of E depends not only on the “sink strength” as hypothesized by Dalton, i.e. the ability of the air to hold escaping water molecules, but also on the energy balance. The resulting Penman combination equation was the first attempt to introduce a method for calculating E from meteorological data. The method worked best for open water in Penman’s experiment. E from a grassy surface was calculated to be about 75% of E from open water. In 1972 C. Priestley and R. Taylor made an attempt to parameterize Penman’s combination equation in order to exclude the advection aspect which they hypothesized to be insignificant over land compared to open water. To compensate for the fraction of E contributed by advection, the radiation part of the equation is multiplied by a coefficient  $\alpha$  that was determined experimentally to be equal to 1.26. In recent years the Priestley-Taylor equation (PT) has been frequently criticized for the lack of physical evidence to support the empirically derived constant  $\alpha$ . Some researches also found that the constant varies regionally (Abtew and Obeysekera, 1995; Hill and Neary, 2006). Among the critics of the PT equation was J. Monteith. As an alternative to it, he proposed an extension to the Penman equation which became known as Penman-Monteith method (PM) (Monteith, 1981). Monteith also criticized the use of pans to estimate evaporation from open water as a “time-wasting anachronism.” Instead he encouraged the use of radiation based Penman-type equations wide application



of which has been made possible in the recent years by the vast availability of meteorological data. The Penman-Monteith method was further developed into FAO56 (Allen et al., 1998). The main objective of FAO56 is to simplify the application of PM by removing the uncertainty in estimating aerodynamic resistance and bulk area resistance coefficients. FAO56 calculates reference evapotranspiration ( $ET_0$ ) which was defined by Allen et al. (1994). They described  $ET_0$  as ET from a well-watered grass cover clipped at 0.12 m with bulk surface resistance equal to 70 s/m. Studies dealing with different methods of calculating ET rates concluded that methods based on the Penman equation are highly reliable and affordable compared to other methods (Abtew, 1996). Since FAO 56 was introduced in 1998, it became a preferred method for estimating  $ET_0$  for its high accuracy and relative simplicity of obtaining and processing data. Unlike all the other methods described above, FAO56 was not intended to calculate E from open water. However, the method was validated for open water bodies by Craig (2006) who found that E from open water is within 10% from  $ET_0$  calculated by FAO56. He stated that the method can be applied to open water under condition that the water body in the analysis has surface area >1ha and is relatively deep (>1m).

Another way of estimating seepage from a water balance equation can be derived from the observed diurnal fluctuations of the water level. This method, based on the White equation, is most often applied to groundwater to estimate ET from soil rather than E from open water. It has been applied to open water, but the results tend to be much higher than estimates by any of the energy based equations such as PM, PT, or Penman

(Hill and Neary, 2006). It leads to believe that this method does not account for certain physical phenomena when applied to open water.

### **1.3 Subsurface water**

The subsurface water may be in the form of a perched, surficial or confined/semi-confined aquifer. The Floridan aquifer is semi-confined by the overlying layer of clay, so precipitation that seeps into the ground recharges the surficial or perched aquifer first. Then due to a built-up head between the surficial and Floridan aquifers, the water starts to seep through the clay layers into the Floridan aquifer. The ponding of water as a result of slow subsurface drainage is common in areas where the water table in the surficial aquifer comes close to the land surface. The problem is especially pronounced in areas with shallow clay pans. Seepage rates help to assess the significance of subsurface drainage for flood control.

This study has multiple applications beyond its primary purpose of flood management. Seepage rates are often analyzed to estimate aquifer recharge. Multiple studies of seepage rates in the context of recharge have been done in arid regions to ensure proper water management (de Vries and Simmers, 2002; Scanlon et al., 2002). In humid regions, however, recharge is usually a part of the overall water budget analysis and is rarely considered separately. As groundwater management becomes more challenging with the growing water demand, the recharge term should be estimated with more care. Most groundwater seepage studies focus on the water traveling through the vadose zone. Studies evaluating and comparing different methods of estimating recharge

to the surficial aquifer in humid climates and fractured rock environments are abundant (Jones and Banner 2003, Heppner et al. 2007). Those studies offer little help in terms of groundwater management in Florida because they estimate the recharge to the surficial aquifer and not to the deep semi-confined aquifer from which the groundwater is withdrawn. Studies on recharge to the deep aquifer remain scarce. This study will shed some light on recharge rates of the Floridan aquifer. However, recharge rates estimated by this study must be used with care as closed basins tend to collect runoff and lateral inflow immediately after storms. As a result, higher than average gradients between the surficial and deep aquifer can lead to higher than average seepage values that would represent local and not regional recharge.

## CHAPTER TWO

### MATERIALS AND METHODS

#### 2.1 Sites

The study was conducted in Hillsborough County, Florida. The sites were selected and identified as closed basins by the Stormwater Management Section of the Public Works Department of Hillsborough County. Five sites are listed including three bodies of surficial water and two groundwater sites.

Table 1 Instrumented sites.

Number	Site	Surface water/ Groundwater
1	Botanical Gardens, University of South Florida, Tampa	Surface
2	Lake Fritz, Lake Park, Dale Mabry Hwy and Van Dyke Rd, Tampa	Surface
3	Post Office, Brandon Blvd and Miller Rd, Valrico	Groundwater
4	Sinkhole, Parsons Ave and Watkins Way, Brandon	Groundwater
5	Lake Wimauma, Wimauma	Surface

Site 1 is a retention pond with an approximate surface area of 8 ha. It receives large amounts of runoff from the adjacent areas (approximate drainage area reported by

Hillsborough County Water Atlas = 1900 ha). A weir on the west side of the pond allows excess water to drain to another lake with a lower elevation.

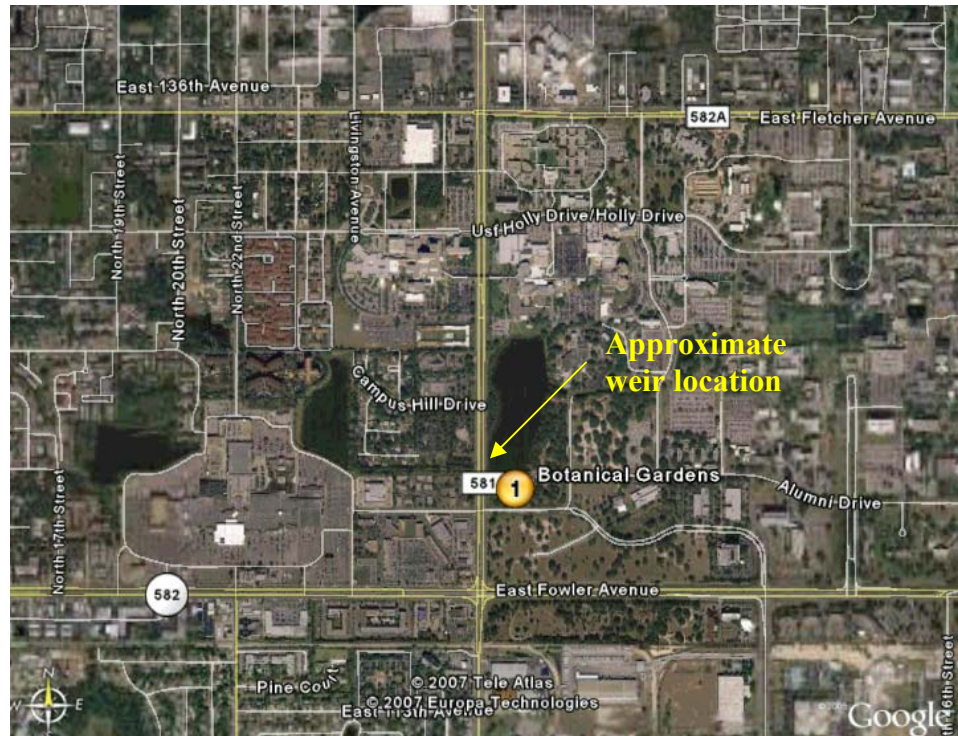

Figure 1 Site 1 satellite map (Google Earth).

Site 2 is a lake with an area of approximately 7 ha. Water is being pumped for municipal needs from the Floridan aquifer in the vicinity of the lake. The map below provided by Tampa Bay Water shows the locations of the pumps. The closest pumping site is approximately 150 m away from the lake. Although the water is extracted from the deep aquifer, it is hydraulically connected to the lake. The water table depression cone around the pump in the proximity of the lake is likely to create head gradients that increase seepage rates from the lake.



Figure 2 Active pump locations (marked with stars) in Lake Park (provided by Tampa Bay Water).

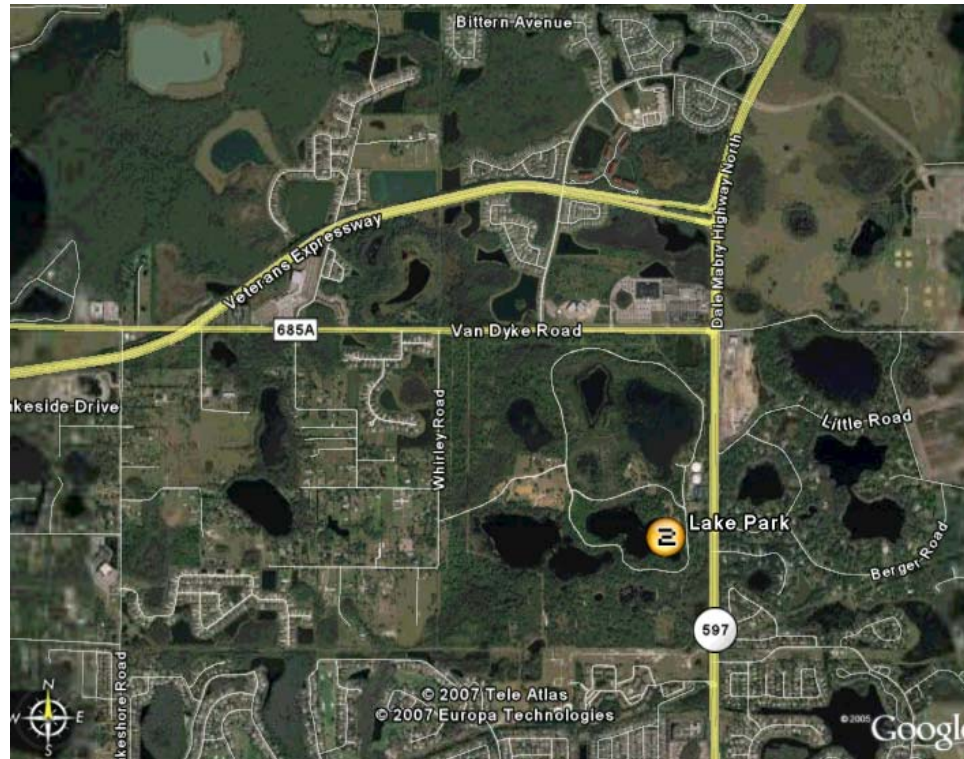

Figure 3 Site 2 satellite map (Google Earth).

Site 3 is a subsurface water level monitoring location. The water table is relatively deep in the area but the presence of a clay pan only 1.5 m below the land surface creates a transient perched water table following large storm events. Three wells were installed at the location: (a) a 7.6 m well monitoring water level in the surficial aquifer; (b) a 31.4 m well monitoring water in the Floridan aquifer; (c) a 1.5 m well measuring water level in the top layer of soil above the shallow clay pan. The 7.6 m and the 31.4 m wells had perforations only in the bottom 3 m which allowed them to measure average piezometric pressure at perforation. The shallow 1.5 m well was perforated all the way through to avoid air pressurization during storms of high intensity and to prevent erroneously high water level readings that could result from that (Nachabe et al., 2004).

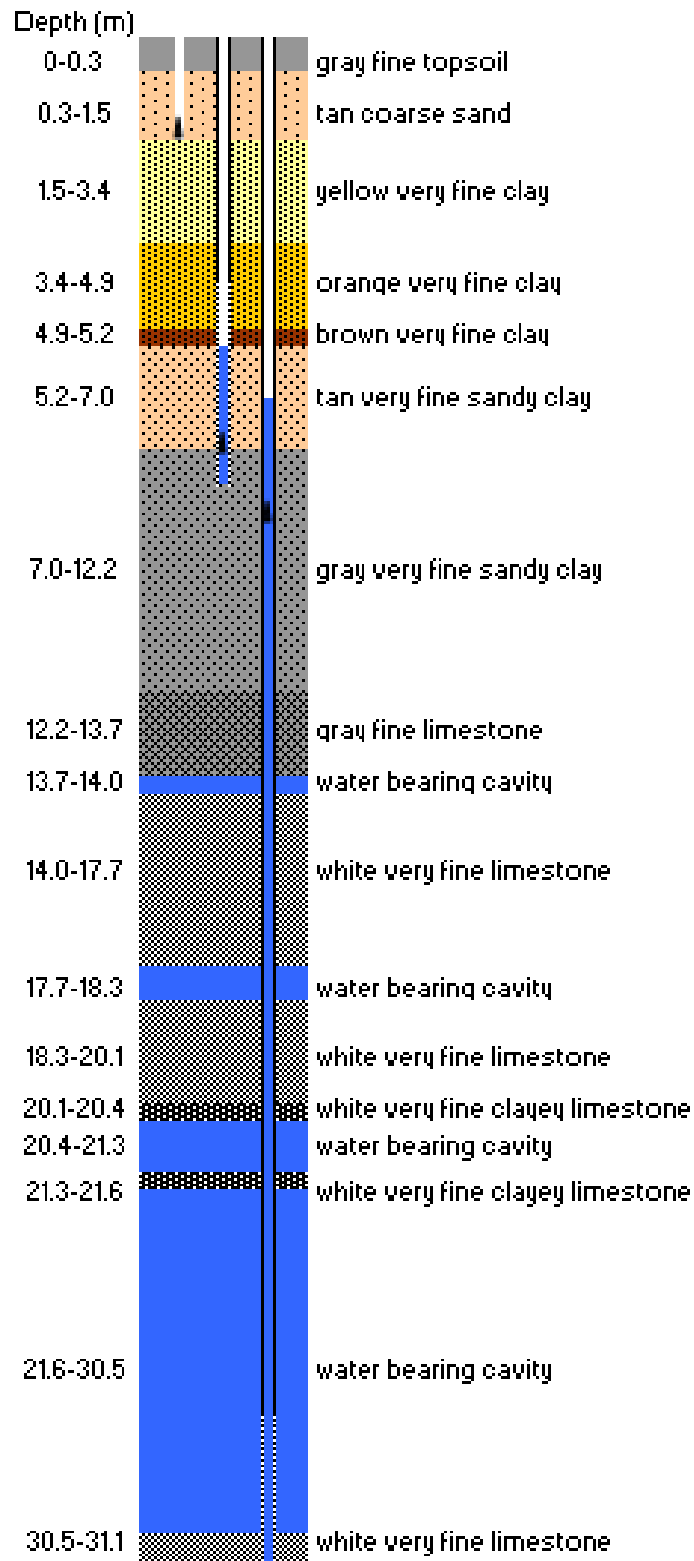

Figure 4 Soil layers and well depths (cross-section) at Site 3. Not to scale.



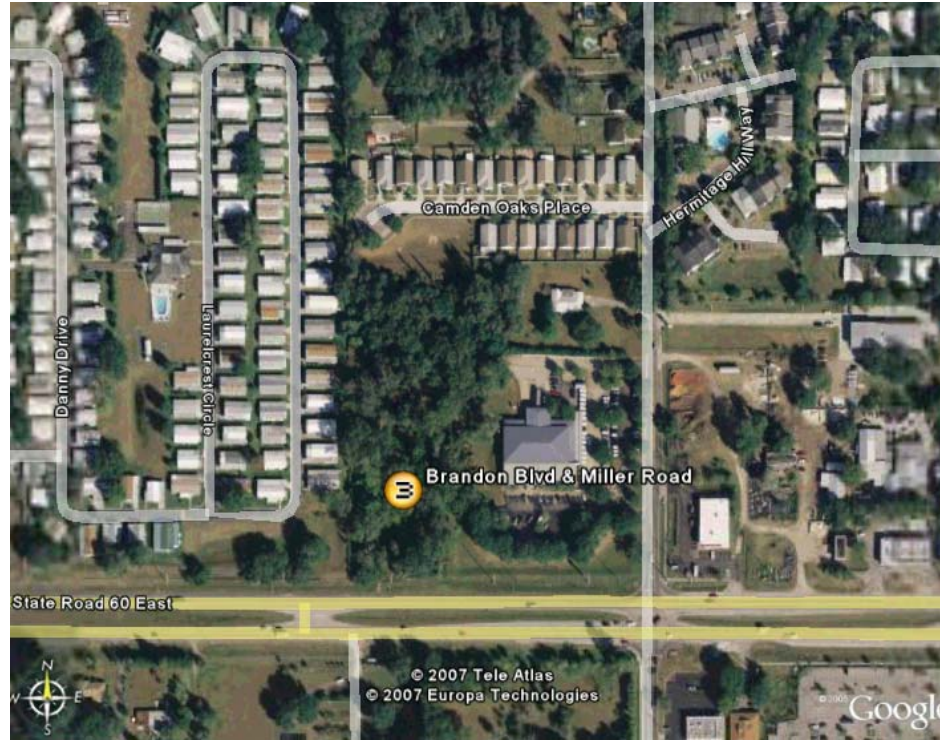

Figure 5 Site 3 satellite map (Google Earth).

Site 4 is a sinkhole that fills up with water during the rainy season. The environment is different from the other subsurface water monitoring site (Site 3): the soils are mostly sandy and no transient perched water table is present. Therefore, only two wells were installed at Site 4: (a) a surficial well 7.6 m deep; (b) a 36.6 m deep well monitoring water level in the Floridan aquifer. Both wells have perforations only in the bottom 3 m of the pipe and measure average piezometric pressure at a perforation.

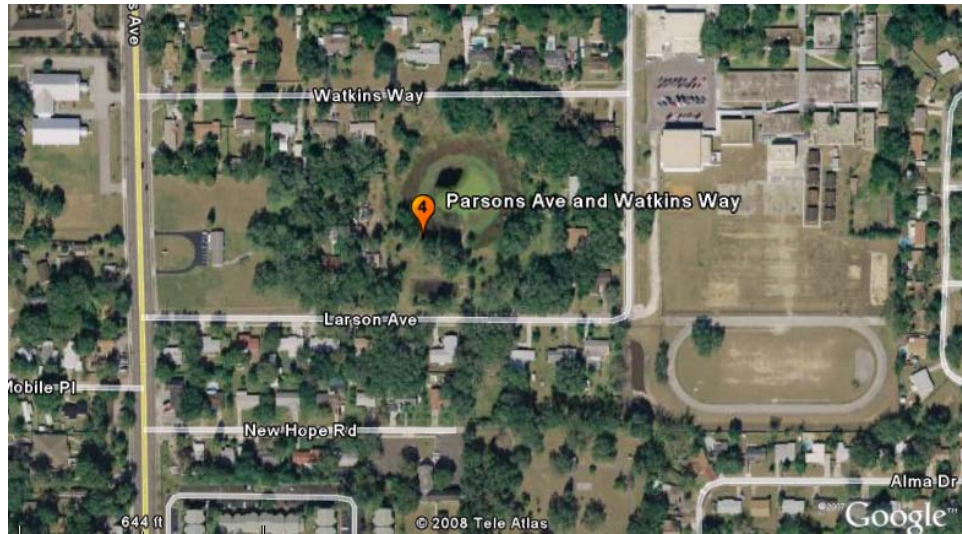

Figure 6 Site 4 satellite map (Google Earth).

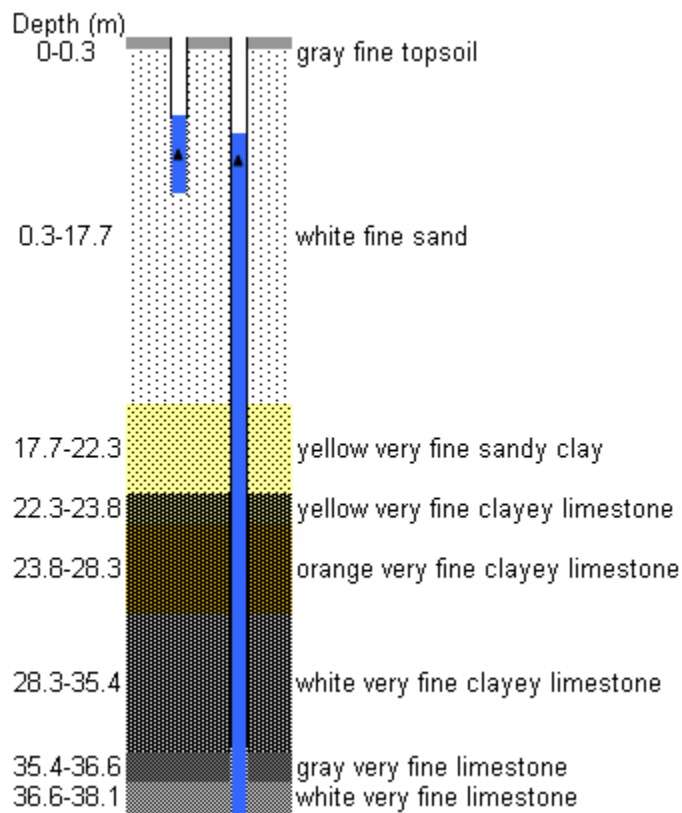

Figure 7 Soil layers and well depths (cross-section) at Site 4.

Site 5 is a lake with an area of approximately 38 ha in a residential area. The lake is used mainly for recreation by the owners of adjacent properties. There are no hydraulic structures allowing inflow or outflow of the lake, and no pumping occurs directly from the lake.

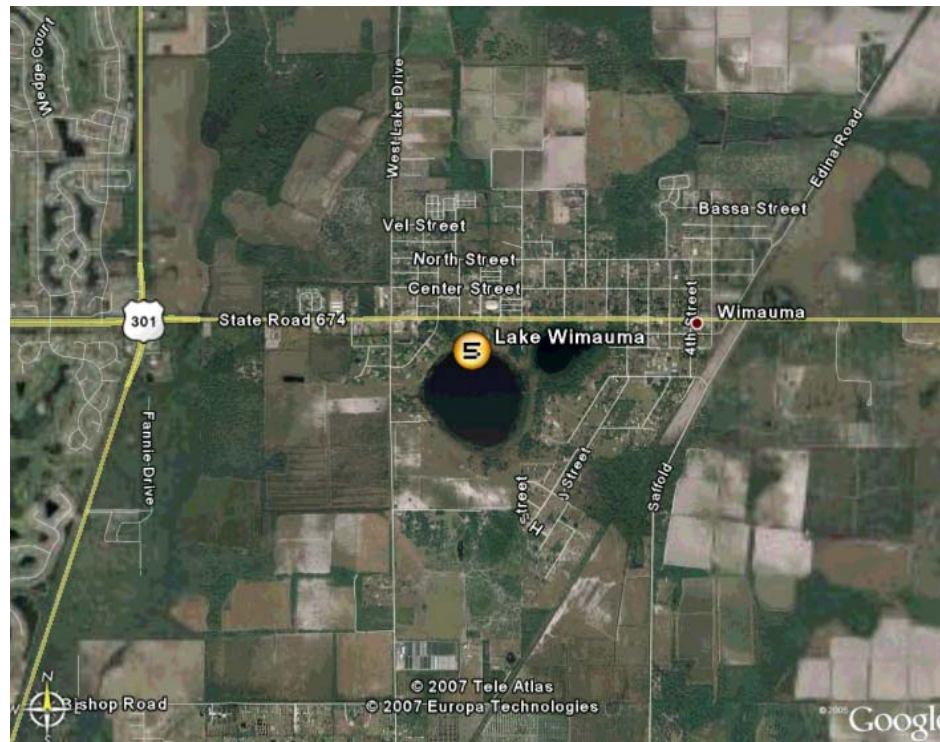

Figure 8 Site 5 satellite map (Google Earth).

## 2.2 Instrumentation

The study utilized pressure sensitive transducers (PSTs) to record water level and barometric pressure. The PSTs were Solinst® Levelogger® Model 3001 with accuracy of 0.05% of full scale (FS) and a resolution of 0.0006-0.002% depending on the range. The transducers with a FS of 5 m were used in the study. The accuracy and resolution for that particular range were reported by the manufacturer as 0.3 cm and 0.005 cm respectively.



Figure 9 Pressure sensitive transducer.

One PST was installed at each surficial water site to measure water level in the lake. The transducer was lowered into a PVC 5 cm diameter well in the lake. A fiberglass cable was used to communicate data from the PST to an onshore box.

Four out of five sites were also equipped with a Barologger<sup>®</sup> – a PST recording barometric pressure. Two sites (No. 3 and No.4) were sharing one Barologger<sup>®</sup> because the variation in barometric pressure was expected to be negligible due to the proximity of the sites to one another: the Euclidean distance between the two sites is approximately 3.9 km.

Variables needed to calculate evaporation were measured by a weather station. Figure 10 below shows the location of the weather station relative to the water level monitoring sites. Site 5 is the most remote from the weather station: approximately 40 km.

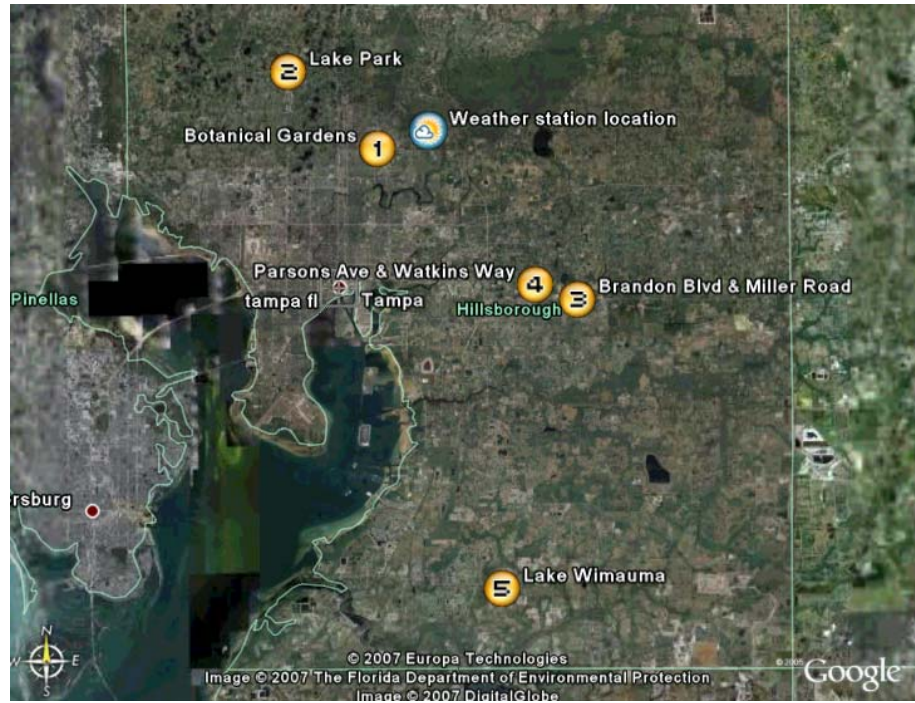

Figure 10 Location of the weather station relative to the water level monitoring sites (Google Earth).



Figure 11 Weather station.

### 2.3 Data collection and processing

Data was recorded by the pressure transducers at a 1 minute interval which was selected based on the accuracy of the equipment and the expected range of water level fluctuations. Water level measurements at open water sites showed a lot of noise that was removed by using a 30-minute moving average filter. As can be seen from the sample of data shown in Figure 12, the overall trend is clearly distinguishable despite the noise in the data.

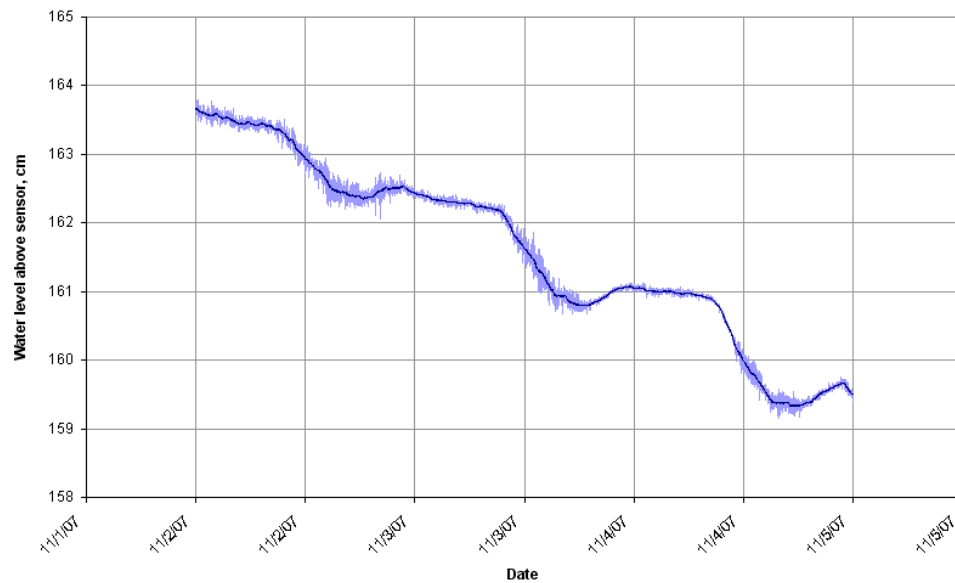

Figure 12 Unfiltered vs. filtered data. Light colored area represents the scatter in data before filter is applied, and the dark line is a smoothed out curve.

Data from the weather station came in 10 minute increments, and readings were used to find daily totals, minimums, maximums, or mean values of the variables necessary to calculate daily E rate by the PM FAO56 method described in Section 2.5.

## **2.4 Methods to calculate seepage rates between a surficial aquifer and a deep aquifer**

Two methods were used: one based on the mass balance and the specific yield of the surficial aquifer, and the other one based on Darcy's Law and the hydraulic conductivity between the two aquifers. In the mass balance method, seepage rates represent the net seepage in both downward and lateral directions. Shortly after storms, lateral flow can be significant in the low lying points of closed basins. As the water table flattens out with time, lateral head gradients decrease and lateral flow becomes small compared to downward flow. Darcy's Law estimates only downward seepage. Net seepage values predicted by the mass balance method are expected to be slightly lower than the ones predicted by Darcy's Law because the former represents downward outflow from the control volume minus lateral inflow.

To estimate the seepage rate at which the exchange occurs between surficial and Floridan aquifers it is necessary to know soil hydraulic parameters such as hydraulic conductivity  $K_s$  [L/T] and specific yield  $S_y$  [-]. Both parameters involve a degree of uncertainty, but while  $S_y$  for a particular soil type can be estimated within a factor of two, the range of values for soil hydraulic conductivity can span several orders of magnitude. Therefore, the seepage out of the surficial aquifer calculated based on the specific yield can have higher accuracy than the seepage calculated using the method based on hydraulic conductivity. The value of hydraulic conductivity was calibrated with the value of specific yield. For that purpose, seepage out of the surficial aquifer was calculated during periods of time without precipitation, when lateral flow is negligible, by using a

typical  $S_y$  value for the soil type. The value of seepage obtained by Darcy's Law was equated to the value of seepage obtained by the mass balance method by adjusting the value of hydraulic conductivity.

The method derived from the mass balance equation states that the change in storage must equal the difference between the net inflow and the net outflow.

$$\text{Change in storage} = \text{Flow in} - \text{Flow out} = S_y (h_{t+\Delta t} - h_t) \Delta x \Delta y$$

$$S_y \delta h / \delta t = \delta q / \delta x + \delta q / \delta y + \delta q / \delta z$$

$$\text{Flow in} = q_{in} |_z \Delta t \Delta x \Delta y$$

$$\text{Flow out} = q_{out} |_{z+\Delta z} \Delta t \Delta x \Delta y$$

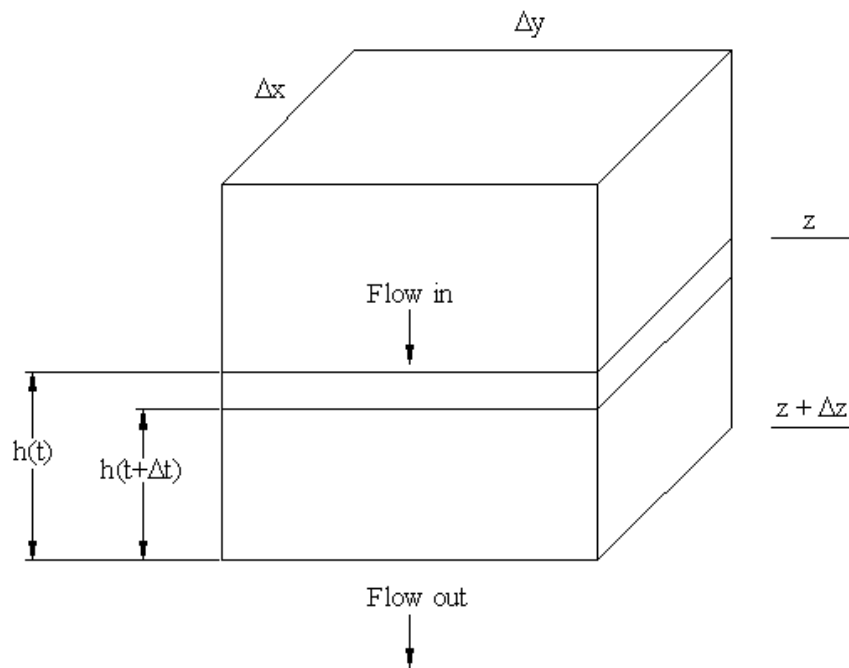

Figure 13 Diagram explaining variables of the mass balance method for calculating seepage into and out of a surficial aquifer.



The seepage rate between the two aquifers was calculated by using Darcy's Law which states that the flow rate (per unit area) between two points in a porous medium is directly proportional to hydraulic head difference and inversely proportional to the path length between the points. The constant of proportionality between the variables for the fully saturated flow such as groundwater movement is saturated hydraulic conductivity.

$$q_z = K_s (H_s - H_{fl}) / L$$

where  $q_z$  is flow in the vertical ( $z$ ) direction [L/T],  $K_s$  is the saturated hydraulic conductivity of the soil [L/T],  $H_s$  is the hydraulic head in the surficial aquifer [L],  $H_{fl}$  is the hydraulic head in the Floridan aquifer [L], and  $L$  is the vertical distance between the points where measurements are taken [L].

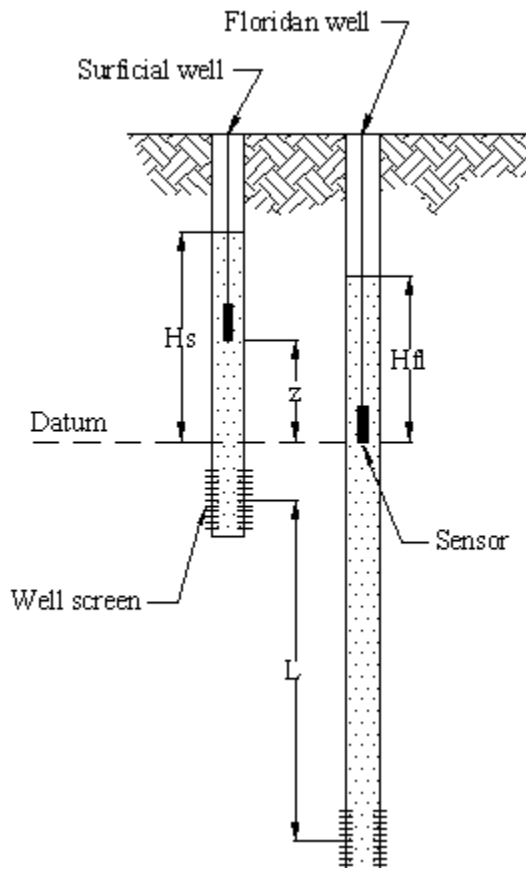

Figure 14 Two-wells diagram showing variables used in Darcy's Law.

## 2.5 Methods to calculate seepage rates between a lake and an aquifer

For open water sites, seepage rates were deduced once all other elements of the water budget were calculated. The rates of E from large bodies of open water were determined by Craig (2006) to be within 10% of  $ET_0$  [mm] calculated using the PM FAO56 method (Allen et al. 1998):

$$ET_0 = \frac{0.408\Delta(R_n - G) + \gamma \frac{900}{T + 273} u_2 (e_s - e_a)}{\Delta + \gamma(1 + 0.34u_2)}$$

The parameters for the equation are temperature and temperature-dependent variables ( $T$ ,  $\Delta$ ,  $e_s$ ), air humidity ( $e_a$ ), solar radiation ( $R_n$ ), and wind speed ( $u_2$ ). All of the variables are either measured directly by the weather station or can be calculated from the measurements.  $G$  is part of energy balance equation called soil heat flux: sensible energy absorbed by the soil and used to raise the soil temperature. Soil heat flux is negligible compared to the net radiation term ( $R_n$ ). Besides, soil heat flux goes from positive to negative in the course of the day as the soil heats during the daytime hours and cools at night. This cycle brings the soil temperature to almost its initial value after 24 hours, and thus for calculation of daily values of ET net soil heat flux can be considered to be equal to zero. Another variable in the PM FAO56 equation that is not measured by the weather station is  $\gamma$ : a constant that depends on the atmospheric pressure at given elevation. The value of  $\gamma$  is 0.067 kPa/°C for elevations below 100 m, and it is calculated by using the following formula:

$$\gamma = \frac{C_p P}{\varepsilon \lambda}$$

where P is atmospheric pressure [kPa],  $\lambda$  is latent heat of vaporization = 2.45 [MJ /kg],  $C_p$  is specific heat at constant pressure =  $1.013 \cdot 10^{-3}$  [MJ/( kg ·°C)], and  $\epsilon$  is a ratio of the molecular weight of water vapor to the molecular weight of dry air = 0.622 [-].

First, the mean daily temperature [°C] is determined as follows and is used in most of the intermediate calculations for FAO56:  $T = (T_{\max} + T_{\min})/2$ . The slope of the vapor pressure curve  $\Delta$  [kPa/°C], and the saturation vapor pressure  $e_s$  [kPa] at temperature T [°C] are calculated using the following formulae:

$$\Delta = \frac{4098 \left[ 0.6108 \exp\left(\frac{17.27T}{T + 273.3}\right) \right]}{(T + 237.3)^2}$$

$$e_s = \frac{e^\circ(T_{\max}) + e^\circ(T_{\min})}{2}$$

$$e^\circ(T) = 0.6108 \exp\left[\frac{17.27T}{T + 237.3}\right]$$

Actual vapor pressure  $e_a$  [kPa] is a function of  $e^\circ(T)$  [kPa] (calculated as shown above) and relative humidity [%] (measured by the weather station).

$$e_a = \frac{e^\circ(T_{\min}) \frac{RH_{\max}}{100} + e^\circ(T_{\max}) \frac{RH_{\min}}{100}}{2}$$

$R_n$  [MJ/(m<sup>2</sup>·day)] is the net radiation which is defined as the difference between incoming net shortwave radiation  $R_{ns}$  [MJ/(m<sup>2</sup>·day)] and outgoing net longwave radiation  $R_{nl}$  [MJ/(m<sup>2</sup>·day)]:  $R_n = R_{ns} - R_{nl}$ . Net incoming radiation is the difference between total

incoming radiation and the fraction reflected. The fraction of incoming radiation that gets reflected is determined by surface albedo  $\alpha$  [-].  $R_{ns}$  is therefore  $R_s(1-\alpha)$  where  $R_s$  [MJ/(m<sup>2</sup>·day)] is total radiation measured by the weather station. For FAO56 the value of  $\alpha$  is 0.23. Net outgoing radiation is also a function of total incoming radiation  $R_s$  measured by the weather station, mean daily maximum and minimum temperatures to the fourth power (in Kelvin), vapor pressure [kPa], and clear sky radiation  $R_{so}$  [MJ/(m<sup>2</sup>·day)]:

$$R_{nl} = \sigma \left[ \frac{T_{\max,K^4} + T_{\min,K^4}}{2} \right] (0.34 - 0.14\sqrt{e_a}) \left( 1.35 \frac{R_s}{R_{so}} - 0.35 \right)$$

In the above equation,  $\sigma$  is Stefan-Boltzmann constant equal to  $4.903 \cdot 10^{-9}$  [MJ/(K<sup>4</sup> · m<sup>2</sup> · day)]. Clear sky radiation is a fraction of the extraterrestrial radiation  $R_a$  [MJ/(m<sup>2</sup>·day)].

The fraction depends on the elevation above sea level  $z$  [m] as shown in the following formula:

$$R_{so} = (0.75 + 2 \cdot 10^{-5} z) R_a$$

Because  $z$  is very small for Florida,  $R_{so}$  is approximately equal to  $0.75R_a$ .  $R_a$  is determined from reference tables and depends on latitude and the month of the year (Allen et al. 1998).

Finally,  $u_2$  is wind speed [m/s] measured by the weather station at the elevation of 2 m above ground. If wind speed measurements are taken at any elevation other than 2 m, the values can be adjusted using the following formula:

$$u_2 = u_z \frac{4.87}{\ln(67.8z - 5.42)}$$

where  $z$  is the elevation [m] where the wind speed was measured, and  $u_z$  is the wind speed measurement [m/s] at that elevation.

Once E rates are calculated, they can be subtracted from the overall water level drop to find how much of the water level recession is attributed to seepage. Each of the three lakes where measurements were taken had its unique characteristics that had to be taken into account when performing analysis.

The lake at site 1 had a weir that controlled the water level. To eliminate  $Q_{\text{weir}}$  term of the mass balance equation, the elevation of the weir was established by observing the distance between the crest of the weir and the water level and comparing it to the reading made by PST. The obtained elevation agreed with the value reported by Hillsborough County. Because the lake receives large amounts of runoff, and the extents of the catchment were not available for this study, R and P terms were also eliminated by choosing periods of no rain for the analysis. Unlike other lakes in this study that remained recharge lakes throughout the study period, lake at site 1 fluctuated from recharge to discharge diurnally. The advantage of this study is that it does not have to take into account this complex behavior since it measures daily net seepage.

In the recharge lake at site 2, water was constantly dropping and was raised only by precipitation and runoff from the adjacent closed basin. The pumping of the groundwater in the nearby area was hypothesized to affect overall seepage rate from the lake. Only periods of no rain were considered in the calculations.

The lake at site 5 was also a recharge lake, and just like in the case with lakes at sites 1 and 2, only periods of no rain and no runoff were considered in estimating seepage.

For all three of the sites, net daily seepage was calculated as well as average net seepage over longer periods of time the duration of which varied depending on the number of consecutive days with no precipitation. The net daily seepage was calculated as follows:

$$\Delta WL = WL_{i+1} - WL_i = -E - q$$

$$q = -(WL_{i+1} - WL_i) - E$$

where  $q$  is the seepage rate [ $L \cdot T^{-1}$ ] (seepage out was defined as positive),  $WL_i$  is the water level measurement recorded by PST on day  $i$  [ $L$ ],  $WL_{i+1}$  is the water level measurement taken 24 hours later [ $L$ ], and  $E$  is the evaporation rate set equal to  $ET_0$  calculated by PM FAO56 [ $L \cdot T^{-1}$ ]. The time for the water level measurements used for daily calculations was set for 12 a.m. when  $ET$  is at its minimum.

Seepage rates over longer periods of time were determined by fitting a line through data points corresponding to water level measurements over the number of consecutive days without precipitation. The slope of the line represented an average rate of change of the water level over the period in consideration. An arithmetic mean of  $E$  for the period was calculated. The obtained value of  $E$  was subtracted from the value of the slope of the line to get the average seepage rate for the period.

## CHAPTER THREE

### RESULTS

#### 3.1 Botanical Gardens

The lake at the Botanical Gardens was losing on average 1.1 cm/d of water due to seepage. The value represents the net daily seepage out of the lake. The actual rate fluctuates in magnitude throughout the day as the lake is recharging during daytime hours and discharging at night. Figure 15 illustrates this phenomenon.

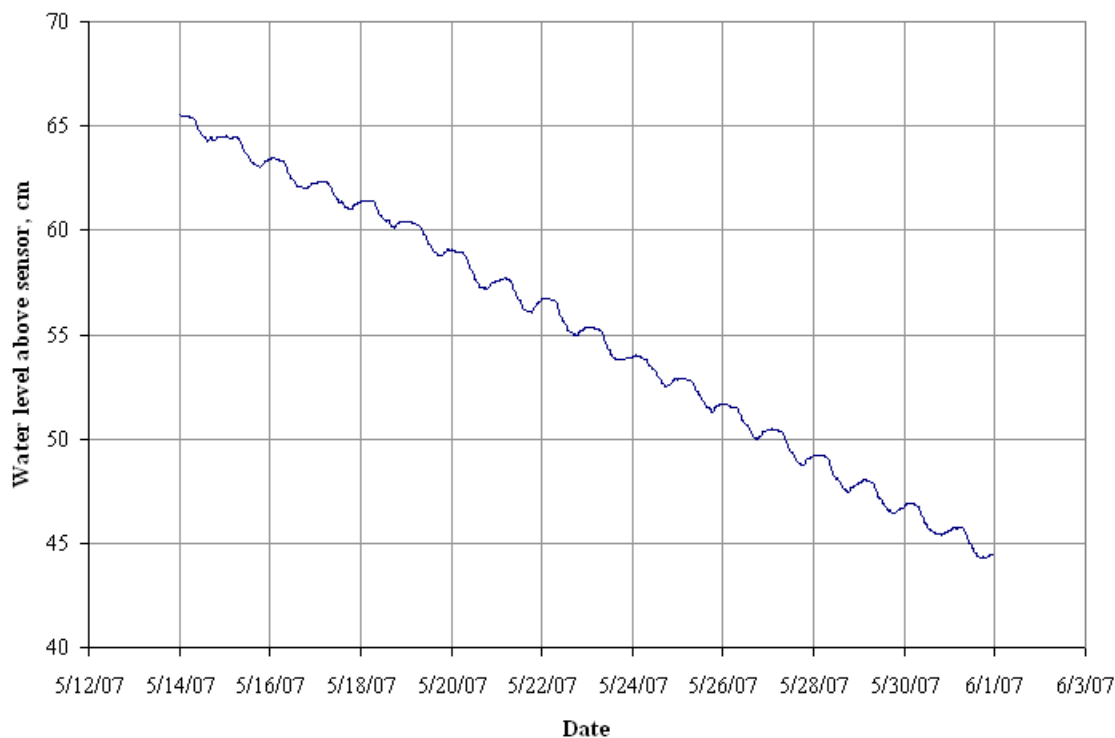

Figure 15 Diurnal fluctuations of the water level at Botanical Gardens.

This kind of behavior was described before for the shallow water table in a densely vegetated riparian area by Schilling (2007) who hypothesized that high evapotranspiration in the area creates a localized depression in the water table that results in an influx of water once the ET virtually ceases during the nighttime hours. The lake at the Botanical Gardens is surrounded with dense vegetation which could be causing the observed diurnal variations in recharge/discharge conditions. The lake exhibited rather constant daily net seepage compared to the other monitored sites. During the period of April 2007 to June 2008, 222 days qualified as the days with no precipitation or surface runoff. The days when lake stage exceeded the elevation of the weir were also excluded from the analysis. The average seepage was determined as 1.1 cm/d with the values ranging from 0.7 to 2.0 cm/d. The seepage values were obtained by fitting a line through the data points corresponding to the dry period as described in the materials and methods chapter. When each day was considered individually instead of the whole period, the data produced much more scatter and exhibited a wider range of fluctuation of 0.3 to 2.1 cm/d. The average for individual days was 1.0 cm/d. Daily seepage values were examined for correlation between seepage rates and the number of days since the preceding storm. Seepage was highest during the first few days after the storm and decreased in the following days (Figure 16). The data exhibited a strong correlation with  $R^2 = 0.71$  and P-value =  $6.75 \cdot 10^{-7}$  at 95% confidence level. It appears from the graph that seepage approaches a value lower than the calculated arithmetic average.



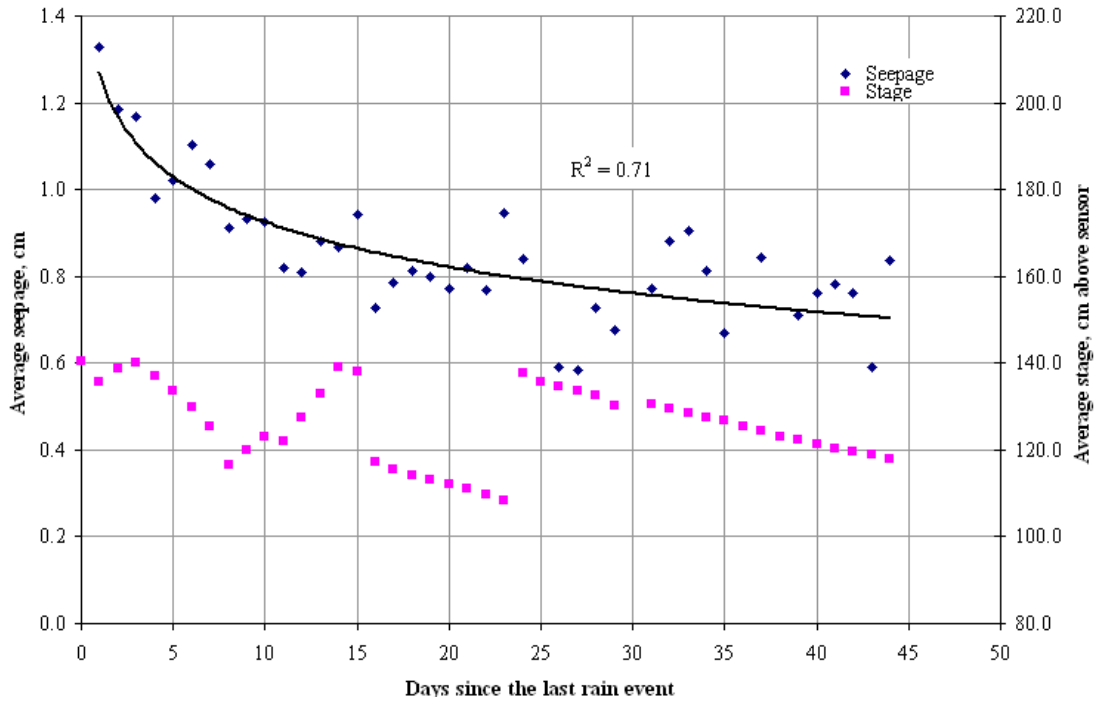

Figure 16 Botanical Gardens: correlation between time since precipitation and seepage and stage.

Scatter in the data was removed to make the analysis of the correlation between seepage and stage more meaningful: seepage values were averaged for 10 cm intervals of the lake stage elevation. The interval of 95-105 cm above sensor was an extreme outlier and was removed from analysis. Figure 17 shows the results of the analysis. A strong linear correlation ( $R^2 = 0.74$ ,  $P\text{-value} = 3.61 \cdot 10^{-4}$  at 95% confidence level) was observed between seepage and stage.

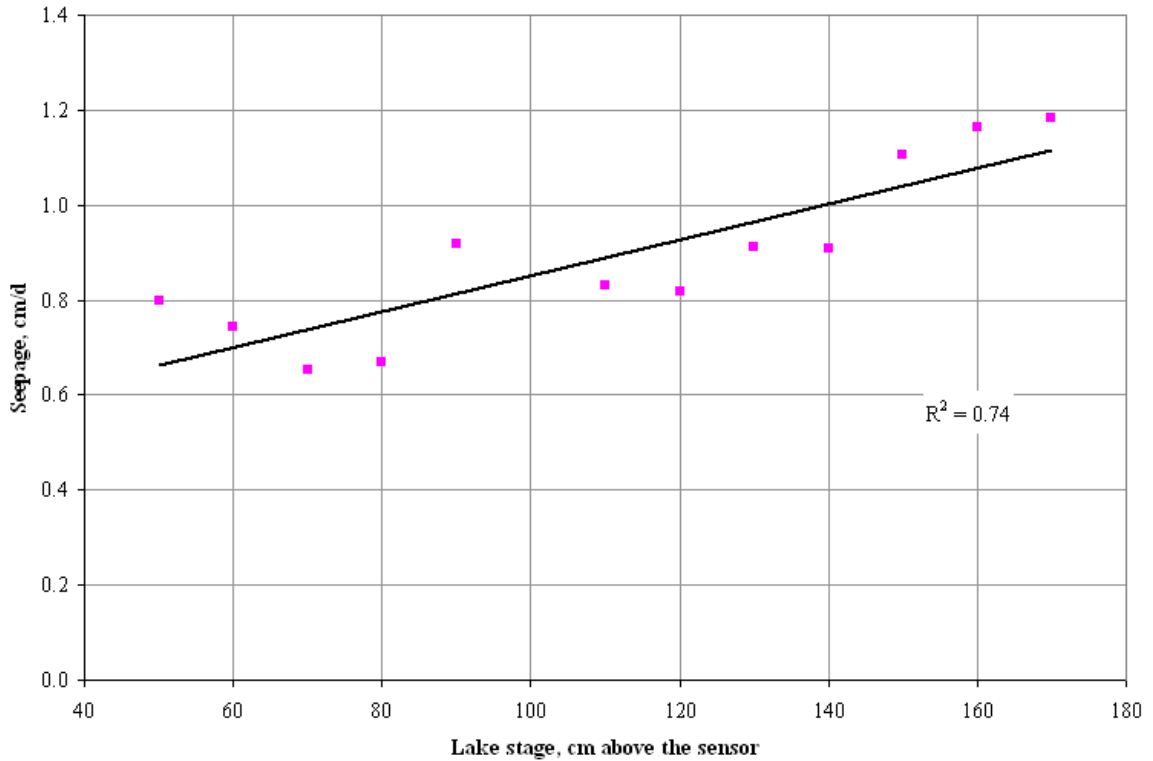

Figure 17 Botanical Gardens: seepage as a function of lake stage.

### 3.2 Lake Park

Data from Lake Park was collected from May to November 2007. The water level was dropping continuously until it fell below the sensor in November 2007. After that the shoreline continued receding as the lake was drying out. Groundwater pumping in the area appeared to be a significant factor contributing to the increase in seepage from the lake. Figure 18 shows an example of instances when the effect of pumping is clearly seen on the hydrograph. Pumping is most likely affecting the seepage through reducing the head in the Floridan aquifer. As a result, the head difference between the lake stage and the aquifer increases causing a rise in seepage.

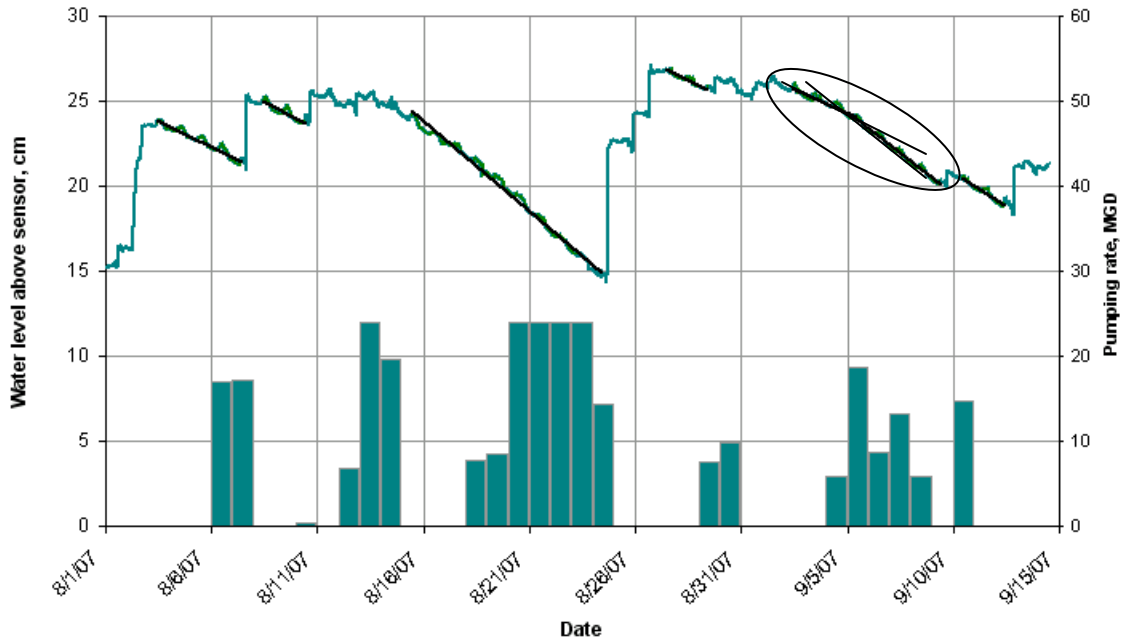

Figure 18 Impact of pumping on seepage rate. Calculated seepage rates for each period indicated in the figure are 0.21, 0.33, 0.66, 0.23, 0.30, 0.67, and 0.54 cm/d respectively. Higher rates coincide with extensive pumping. For example, in the circled region seepage rate doubles when the pump is turned on.

Twenty stretches of 2 or more days without rain occurred during the months of water level monitoring. The total number of daily data points was 100. The lake exhibited a large range of seepage values: from 0.0 to 1.0 cm/d when seepage was calculated for dry periods and from 0.0 to 1.2 cm/d when daily values were considered. The respective averages were 0.5 and 0.7 cm/d. The arithmetic average did not accurately reflect the value that seepage appeared to approach once the lake reached steady conditions, i.e. seepage measured long after a rain event when lateral gradients disappeared and seepage was mostly in the downward direction. From Figure 19 (a), the steady value appears to be approximately 0.8 cm/d and is reached in approximately 10 days after a rain event of any magnitude. Correlation between seepage and times since previous rain event is

considerable with  $R^2 = 0.81$  and P-value =  $2.24 \cdot 10^{-7}$  at 95% confidence level. Figure 19 (b) examines correlation between lake stage and seepage. Correlation was moderate with  $R^2 = 0.45$  and P-value =  $8.21 \cdot 10^{-3}$  at 95% confidence level for linear regression. The first few days immediately after the event exhibited the most scatter, and a regression analysis showed that the seepage rate during those days displays a significant correlation with the cumulative rainfall reflected by the lake stage (Figure 20). The relationship between the magnitude of the event and net seepage the following day appears to be linear with  $R^2 = 0.77$  and P-value =  $4.04 \cdot 10^{-3}$  at 95% confidence level.

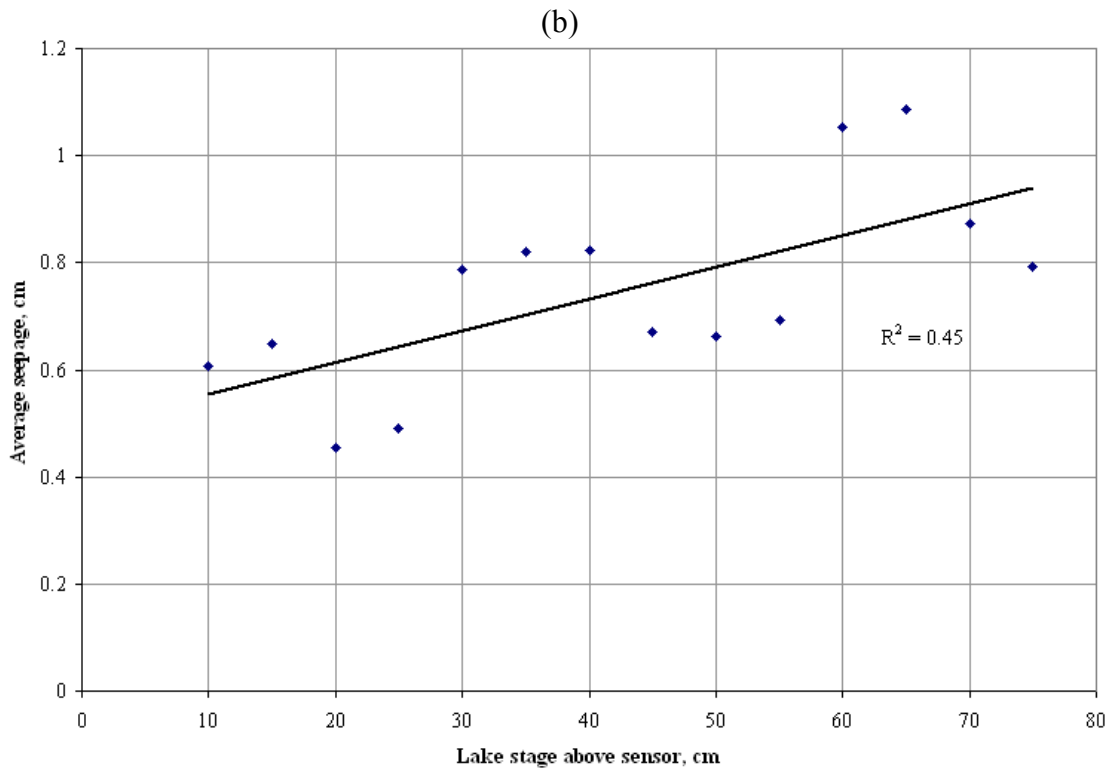
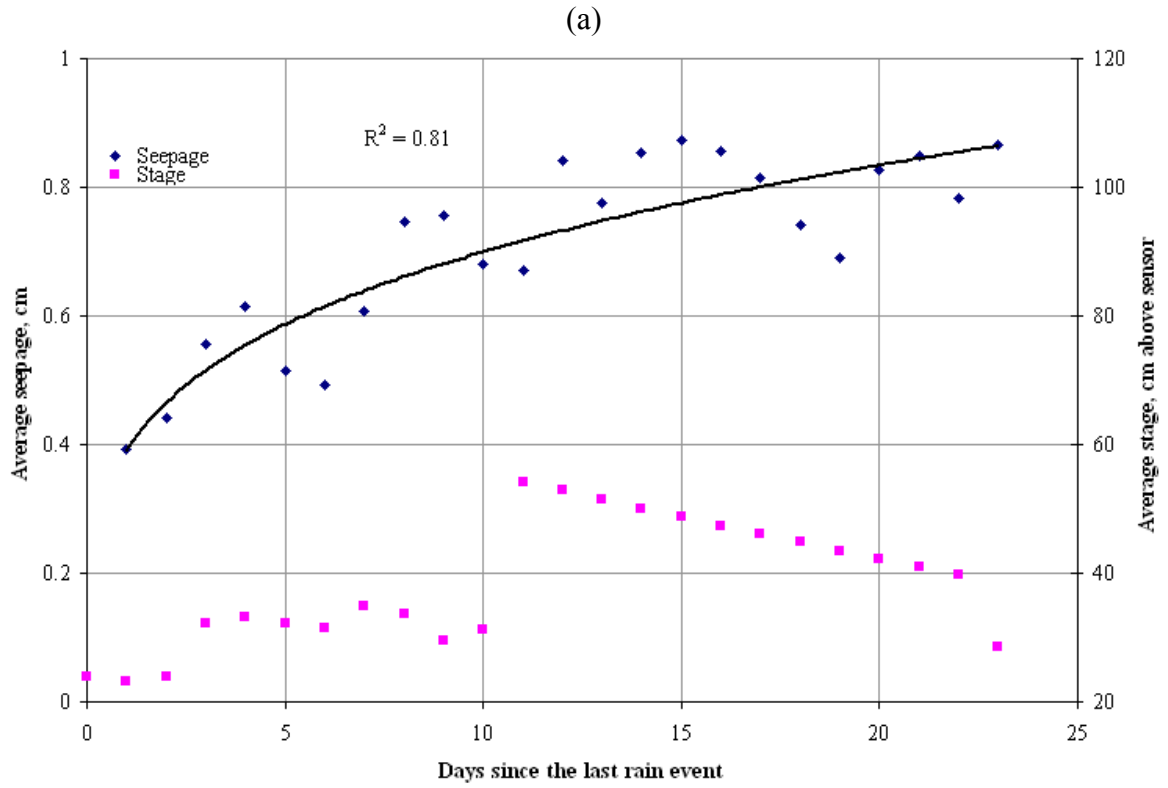

Figure 19 Lake Park: correlation between (a) the time since the preceding precipitation event and seepage and stage, and (b) seepage and lake stage.

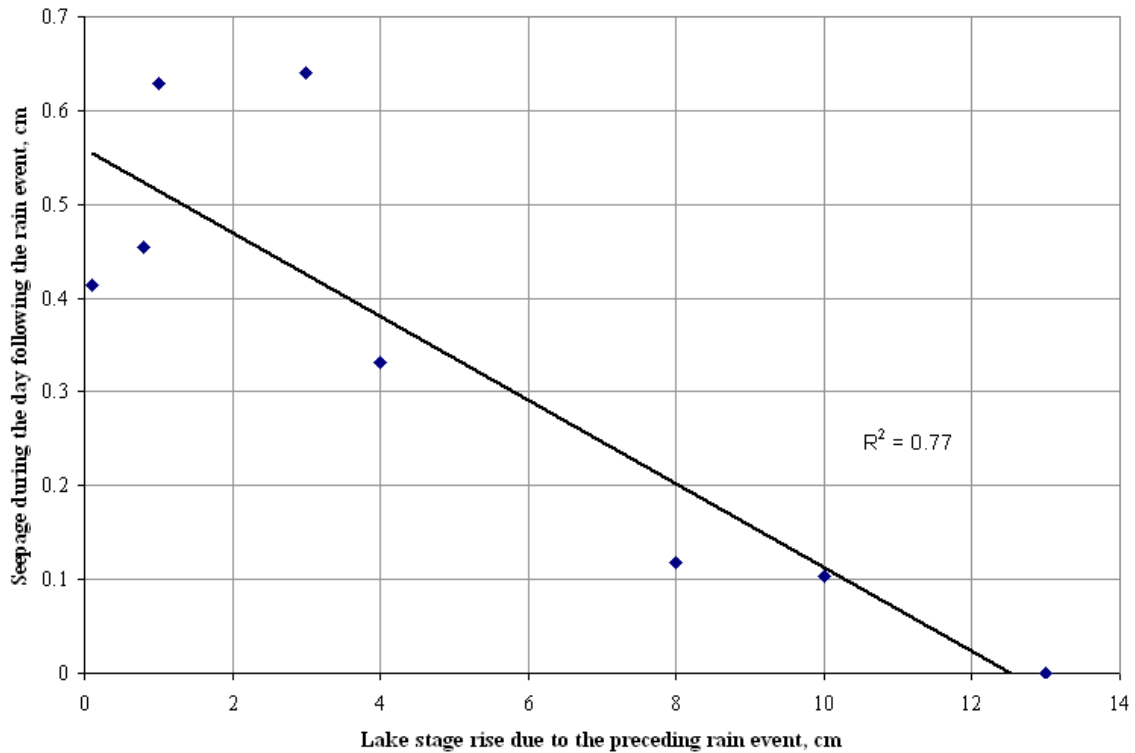

Figure 20 Lake Park: correlation between seepage during the day following the rain event and the magnitude of the event.

The seepage rates immediately after a large magnitude rain event were very small and over the course of several days gradually increased to the steady value. The behavior is very different from that of the Botanical Gardens lake and could be the result of the amount of runoff each lake is receiving. The difference between the responses of the two lakes to major storm events is illustrated in the Figure 21. Case (a) is a diagram of a lake that receives enough runoff to raise the lake stage above the water table which causes the increase in seepage out of the lake (similar to the lake at Botanical Gardens). Case (b) represents a lake that does not receive enough runoff to elevate the stage above the water table (similar to the lake at Lake Park).

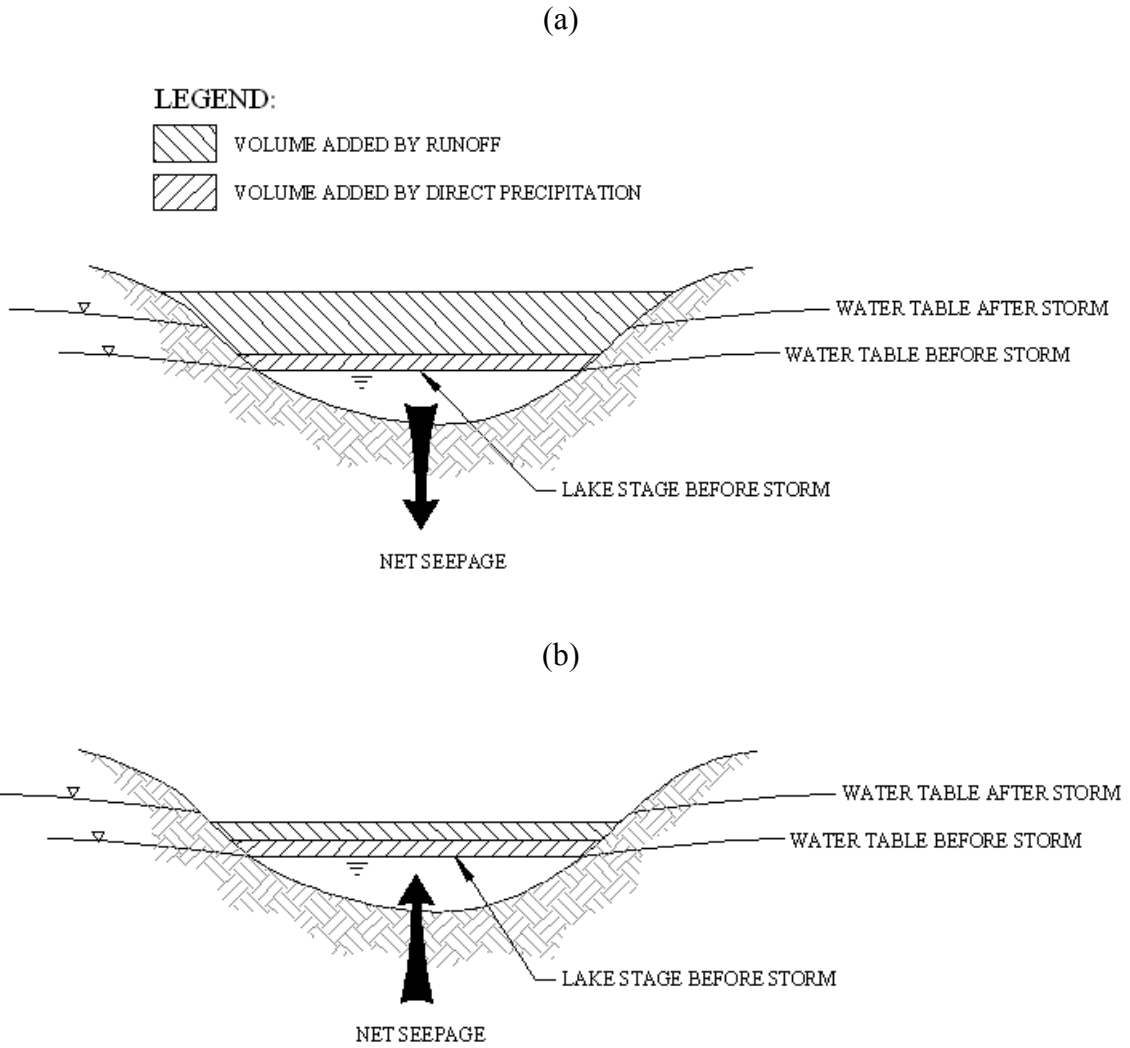

Figure 21 Diagram of the response of seepage to rain events in lakes receiving (a) large and (b) moderate amounts of runoff. Not to scale.

### 3.3 Lake Wimauma

Data from May 2007 to July 2008 was analyzed. During this time 35 dry periods were considered consisting of 226 days total. The range of fluctuation in the seepage values obtained by analyzing periods of no rain was 0.1 to 0.9 cm/d, and the daily values ranged from 0.0 to 1.0 cm/d. The average for both periodic and daily seepage was 0.4

cm/d. Seepage rates at Lake Wimauma show a lot of scatter most of which was removed by averaging seepage values for each day after the storm (Figure 22). The data from the site appeared to have more noise than the data from other sites which could have contributed to the scatter in the calculated seepage values. The noise could have been introduced by the recreational use of the lake by the local residents and might be exacerbated by the location of the sensor next to a floating dock. Also, average seepage values in Figure 22 (a) exhibit more scatter after about the 20<sup>th</sup> dry day. Only two dry periods in the whole data set lasted longer than 22 days, so all of the data points past the 22<sup>nd</sup> day are averages of only 2 values. Despite the scatter, a moderate correlation between seepage and the number of days since the preceding storm event was still observed ( $R^2 = 0.51$ , P-value =  $1.92 \cdot 10^{-5}$  at 95% confidence level).

No relationship was observed for this site between the magnitude of the preceding event and seepage rates during the first few days following the event. The correlation between seepage and stage was also very weak with  $R^2 = 0.21$  and P-value = 0.152 at 95% confidence level (Figure 22 (b)). However, this is not an indication that there is no correlation as it could have been obscured by the excessive scatter in data or by an insufficient number of data points.



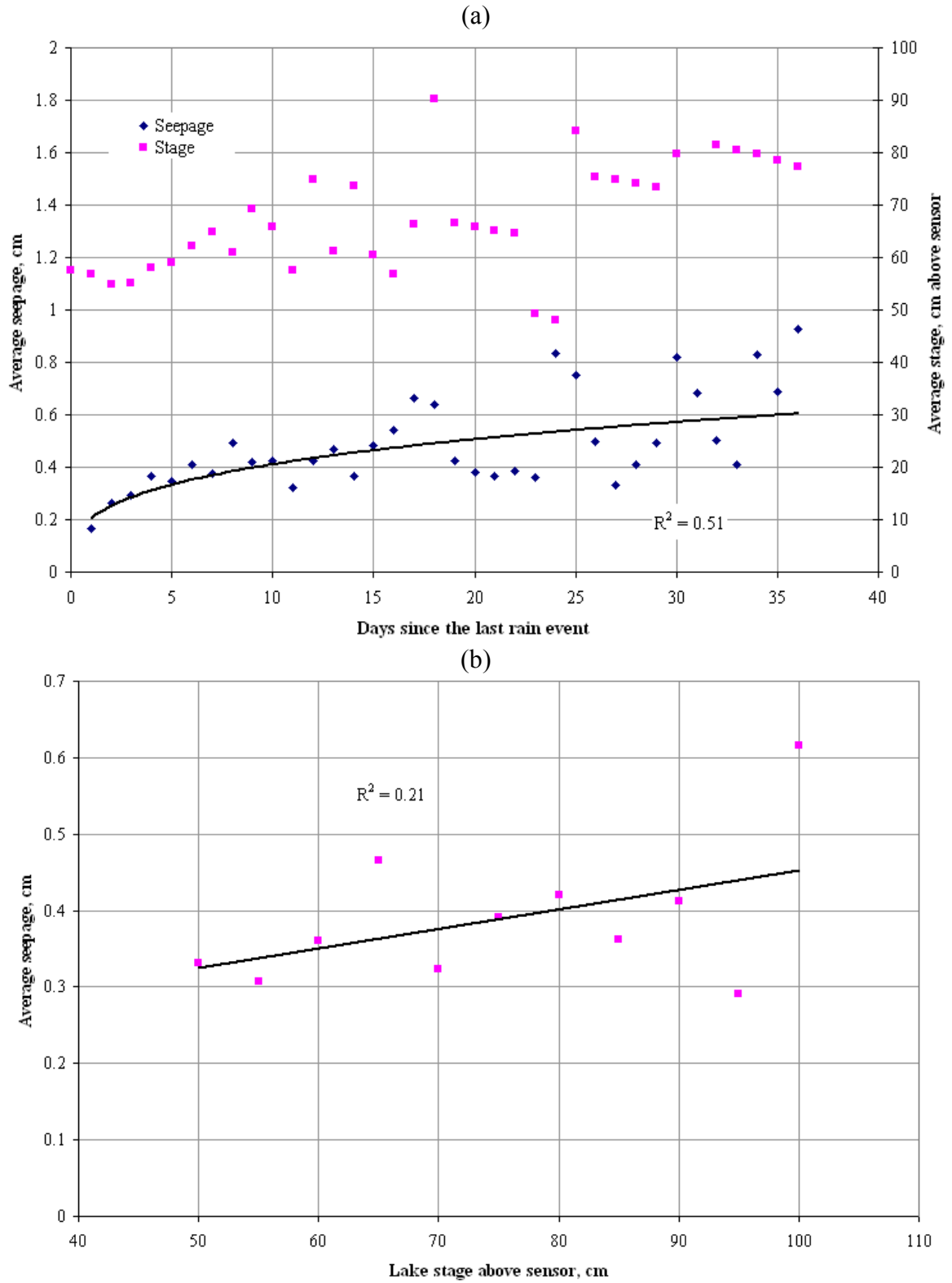

Figure 22 Lake Wimauma: correlation between (a) the time since the preceding precipitation event and seepage and stage, and (b) seepage and lake stage.

### 3.4 Post office

Data from June 2007 through July 2008 was analyzed. The shallow well was introduced later in July 2007 and the hydrograph from the well supported the hypothesis that water ponds above the shallow clay pan. The thin line (Figure 23) represents the elevation of the shallow well sensor when there is no water present above the clay pan. The pulses above the line are the instances when ponding above the clay pan occurred. Ponding was observed only during major storms and dissipated quickly, however during extremely rainy years it is possible that the water level can rise above the land surface. The seepage rate was determined to be approximately 0.1 cm/d on average through the period and remained relatively steady with the exception of the days after major rain events when the rise of the water table in the surficial aquifer increased the head gradient.

The soil layers within the surficial aquifer were heterogeneous vertically. The clay pan started at 1.5 m below the land surface and extended to about 4-5 m below the land surface. Below that there was sandy clay which had a higher value of specific yield than clay because of the presence of coarser sand particles. The values of specific yield used for calculations were 0.07 for sandy clay and 0.02 for clay. These are the average values for these soil types reported by Johnson (1967). The dotted line in Figure 23 represents the approximate location where one soil type gradually transitions into another. The location was determined by observing the hydrograph behavior and was closer to the ground surface than it appeared from the well drilling record that put the bottom of the clay layer at 5.2 m below the land surface. The clay layer is characterized by rapid, high magnitude increases in the water table elevation in response to rain events. The water

table rise of over 2 m was observed in the surficial well once the water entered the clay formation. Another indication of the water table reaching the soil layer boundary is the rapid increase in calculated seepage using the same specific yield value. These factors were used to determine the bottom boundary of the clay pan and to adjust the value of specific yield accordingly. The value of hydraulic conductivity (harmonic average) was found to be approximately 2 cm/d which agrees with the range of values for this soil type reported in literature (Davis and DeWiest, 1966).

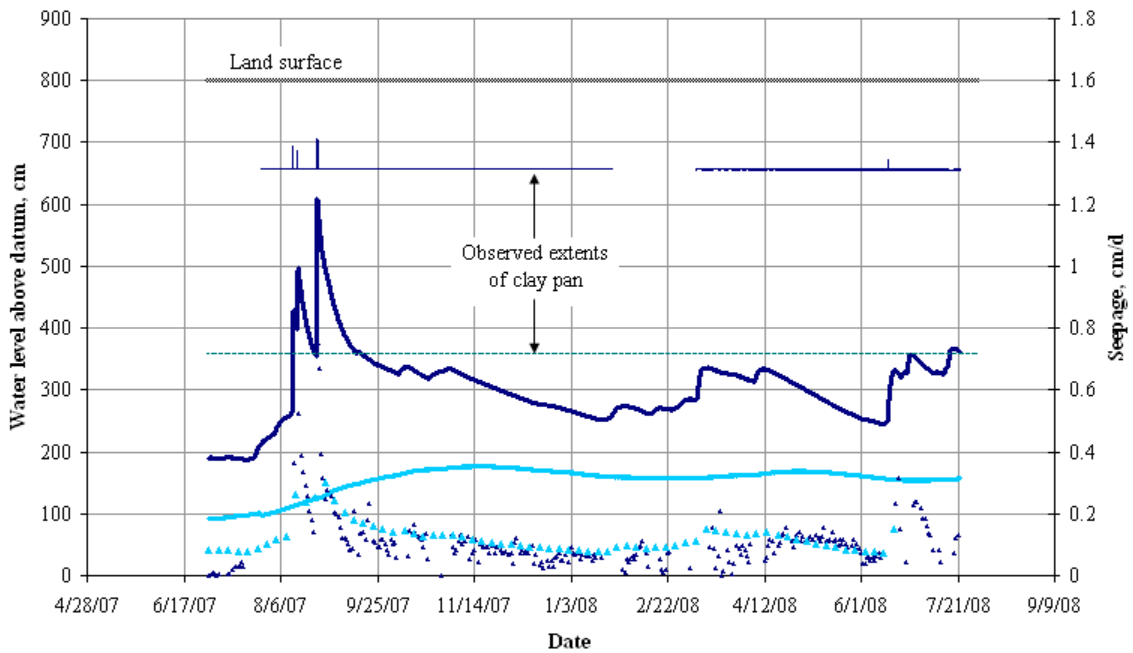

Figure 23 Well hydrographs for the post office site. The thin dark line represents the location of the top of the clay pan as well as the location of the shallow well sensor, the dotted line is the approximate bottom of the clay pan, the thick dark line is surficial well hydrograph, the thick light line is the Floridan well hydrograph, the dark dots are the seepage values calculated using mass balance method, and the light dots are the seepage values calculated using the head gradient method.

### 3.5 Sinkhole

Sinkhole site data was analyzed for the period of time from April 2007 to March 2008. The soil was relatively homogeneous at the site with fine sand extending to about 17-18 m below the land surface. The specific yield used in seepage calculations for the sinkhole site was assumed to be 0.2 which agrees with the values reported in literature for this soil type (Johnson, 1967).  $K_s$  was estimated to be 7 cm/d which is within the acceptable range of values reported in literature (Davis and DeWiest, 1966). The average value of seepage for the period was calculated as 0.4 cm/d although from the graph (Figure 24) it appears to be closer to 0.5 cm/d. The average is lowered by the decrease in seepage during the dry summer of 2007. The values fluctuated between 0.2 cm/d during the dry season when the head gradient between the two aquifers decreased and 0.8 cm/d during the wet season when the gradient was high.

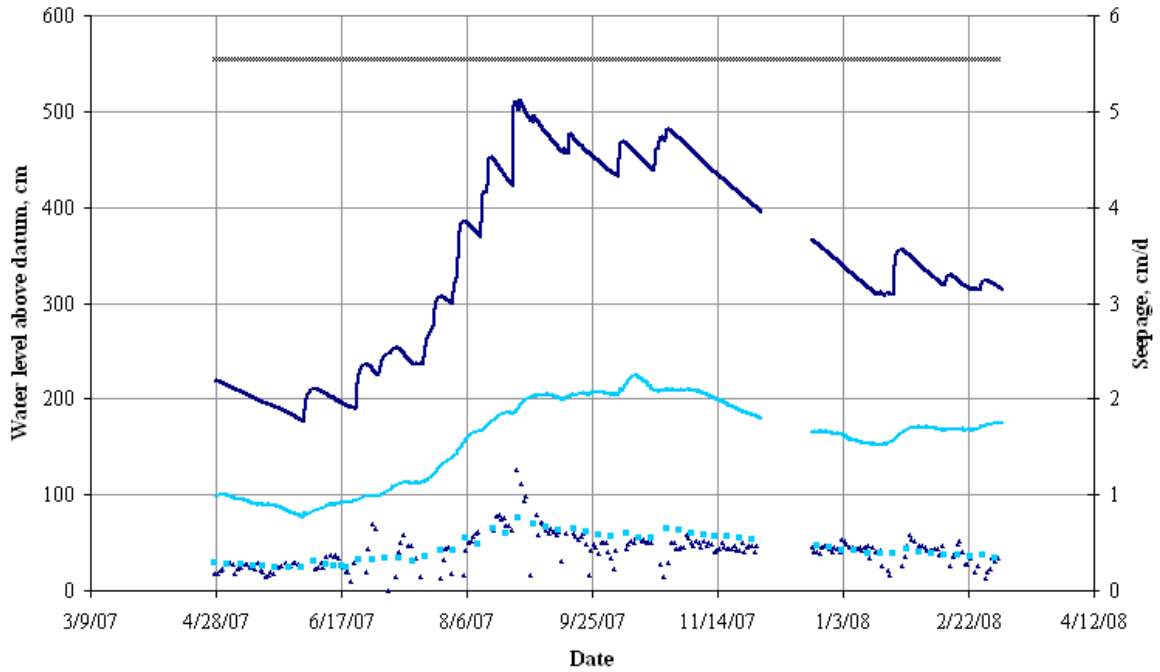

Figure 24 Well hydrographs for the sinkhole site. The straight line on top represents the land surface, the dark line is the surficial well hydrograph, the light line is the Floridan well hydrograph, the dark dots are seepage values calculated using the mass balance method, and the light dots are seepage values calculated using the head gradient method (Darcy's Law).

## **CHAPTER FOUR**

### **CONCLUSION**

The methodology provided a relatively narrow range of seepage values for each basin as well as gave insight on some of the factors contributing to the variability of seepage such as lake stage, the extent of the preceding dry period or the magnitude of the preceding precipitation event. This study shed light on the response of closed basins to rain events and could prove to be an invaluable tool for floodplain modeling.

Based on calculated seepage rates, it appears that seepage may not be a reliable means of flood relief in humid karst environments with a shallow water table. Nor does seepage provide adequate drainage relief during smaller precipitation events. In fact, some of the closed basins in the study exhibited decrease in seepage rates after a rain event. The basin that exhibited an opposite trend – an increase in seepage rates after a rain event – received a disproportionately large amount of runoff.

Recharge values differed greatly in magnitude for the two closed basins with subsurface water. Recharge of 0.1 cm/d at one of the sites amounts to approximately 40 cm/year which accounts for a very small portion of the average annual precipitation. At the other site average recharge of 0.4 cm/d resulted in annual recharge almost equal to the

average annual precipitation. However, it must be noted that the measurements were taken at low points within closed basins where collected runoff creates higher gradients than in other areas of the catchments. Calculated seepage values therefore do not represent average regional recharge in the basin but its localized upper extreme. As seen at the Lake Park site, the magnitude of recharge does not compare with the rate of water withdrawal, and the water table falls down considerably especially during the dryer portion of the year emphasizing the vulnerability of the Floridan aquifer to excessive pumping.

Due to scatter in the seepage data, estimated average seepage values have a certain degree of error. Scatter is common in natural data and is a result of a multitude of factors (some of which are difficult to capture) contributing to the natural phenomena. The method nevertheless can provide a valuable insight on seepage and its variability within a given closed basin. Due to inherent uncertainty associated with natural data, a smaller data collection resolution or a simpler ET estimation method may result in the same degree of error in the calculations. Model sensitivity studies may be warranted to verify the possibility of simplifying the methodology even further.

## REFERENCES

- Abtew, W. 1996. Evapotranspiration Measurements and Modelling for Three Wetland Systems in South Florida. *Water Resources Bulletin* 32: 465-473.
- Abtew, W., Obeysekera, J. 1995. Lysimeter study of evapotranspiration of cattails and comparison of the three estimation methods. *American Society of Agricultural Engineers* 38: 121-129.
- Allen, R.G., Pereira, L.S., Raes, D., Smith, M. 1998. Crop evapotranspiration – guidelines for computing crop water requirements. FAO Technical Paper 56. Food and Agriculture Organization of the United Nations, Rome.
- Allen, R.G., Smith, M., Perrier, A., Pereira, L.S. 1994. An update for the definition of reference evapotranspiration. *ICID Bulletin* 43: 1-34.
- Chiew, F.H.S., Kamaladasa, N.N., Malano, H.M., McMahon, T.A. 1995. Penman-Monteith, FAO-24 reference crop evapotranspiration and class-A pan data in Australia. *Agricultural Water Management* 28 (1): 9-21.
- Craig, I.P. 2006. Comparison of precise water depth measurements on agricultural storages with open water evaporation estimates. *Agricultural Water Management* 85: 193-200.
- Dalton, J. 1798. On evaporation of water below 212°. *Memoirs and Proceedings. Manchester Literary and Philosophical Society* 5: 579-589.
- Davis S.N. and DeWiest R.J.M. 1966. *Hydrogeology*. John Wiley and Sons. New York: 164-165.
- De Vries, J. J. and Simmers, I. 2002. Groundwater recharge: an overview of processes and challenges. *Hydrogeology Journal* 10: 5-17.
- Divine C. E. and McDonnell, J. J. 2005. The future of applied tracers in hydrogeology. *Hydrogeology Journal* 13: 255-258.
- Grismer, M.E., Orang, M., Snyder, R., Matyac, R. 2002. Pan evaporation to reference evapotranspiration conversion methods. *Journal of Irrigation and Drainage Engineering* 128: 180-184.



- Heppner, C. S., Nimmo, J. R., Folmar, G.J., Gburek, W.J., Risser, D. W. 2007. Multiple-methods investigation of recharge at a humid-region fractured rock site, Pennsylvania, USA. *Hydrogeology Journal* 15: 915-927.
- Hill, A.J., Neary, V.S. 2007. Estimating evapotranspiration and seepage for a sinkhole wetland from diurnal surface water cycles. *Journal of the American Water Resources Association* 43 (6): 1373-1382.
- Johnson, A.I. 1967. Specific yield – compilation of specific yields for various materials. U.S. Geological Survey Water Supply Paper 1662-D: 74 p.
- Jones, I.C. and Banner, J.L. 2003. Estimating recharge thresholds in tropical karst island aquifers: Barbados, Puerto Rico and Guam. *Journal of Hydrology* 278 (1-4): 131-143.
- LeBaugh, J. W., Winter, T.C., Rosenberry, D.O., Schuster, P.F., Reddy, M.M., and Aiken, G. R. 1997. Hydrological and chemical estimates of the water balance of a closed-basin lake in north central Minnesota. *Water Resources Research* 33 (12): 2799-2812.
- McBride, M.S. and Pfannkuch, H.O. 1975. Distribution of seepage within lakebeds. *Journal of Research United States Geological Survey* 3 (5): 505-512.
- Monteith, J.L. 1981. Evaporation and Surface Temperature. *Quarterly Journal of the Royal Meteorological Society* 107: 1-27.
- Nachabe, M., Masek, C., and Obeysekera, J. 2004. Observations and modeling of profile soil water storage above a shallow water table. *Soil Science Society of America Journal* 68: 719-724.
- Penman, H.L. 1948. Natural Evaporation from open water, bare soil and grass. *Proceedings of the Royal Society of London. Series A, Mathematical and Physical Sciences* 193: 120-145.
- Priestley, C.H.B., Taylor, R.J. 1972. On the assessment of surface heat flux and evaporation using large-scale parameters. *Monthly Weather Review* 100: 81-92.
- Scanlon, B.R., Healy R.W., and Cook, P.G. 2002. Choosing appropriate techniques for quantifying groundwater recharge. *Hydrogeology Journal* 10: 18-39.
- Schilling, K.E. 2007. Water table fluctuations under three riparian land covers, Iowa (USA). *Hydrological Processes* 21: 2415-2424.